



# SAFETY CATALOGO 21

SIGUREZZA CHE CONQUISTA



SEBA



# DISPOSITIVI DI PROTEZIONE INDIVIDUALE

L'esperienza che **SEBA** ha maturato nella produzione di dispositivi di protezione individuale e di sicurezza le permette di garantire costantemente un servizio di elevata qualità verso la propria clientela, grazie all'affidabilità dei dispositivi e alla puntualità delle consegne.

Partendo dallo studio approfondito delle specifiche esigenze degli utenti finali, **SEBA** è in grado di offrire un sistema di soluzioni combinate, altamente personalizzate dal punto di vista tecnico/funzionale, del confezionamento e dei particolari serigrafici.

A questo si deve aggiungere una completa conoscenza relativa alle disposizioni in materia di dispositivi di protezione individuale, che consente di fornire una consulenza specifica ai propri rivenditori e alle imprese partner.



Il fatturato in costante crescita è il segno tangibile della capacità di risposta di **SEBA** agli oltre 4.000 clienti. I prodotti **SEBA** sono stati studiati e disegnati specificatamente sulla base delle esigenze di

## CAMPI APPLICAZIONE

protezione e di sicurezza dei lavoratori attivi nei settori della produzione alimentare, dell'edilizia, della ceramica, della meccanica, della siderurgia e dell'elettronica.

**SEBA** condivide con la propria rete di fornitori una vocazione verso la ricerca costante dell'ergonomia, del comfort, della sicurezza. Gli investimenti in ricerca riguardano gli apparati e le tecnologie interne e, soprattutto, la formazione ed il capitale

## RICERCA E SVILUPPO

di conoscenze delle risorse umane. Questo permette a **SEBA** di trasferire soluzioni sempre innovative sui dispositivi di sicurezza e gli articoli destinati agli utenti lavoratori.

# DISPOSITIVI DI PROTEZIONE INDIVIDUALE

## QUALITÀ

Al fine di garantire un servizio globale alla propria clientela che rispecchi la qualità dei dispositivi di sicurezza, confermata dalla certificazione ISO 9001, **SEBA** ha istituito un sistema di Assicurazione della Qualità che ha il compito di mantenere sotto controllo gli elementi tecnici, organizzativi ed umani che caratterizzano la relazione con i propri clienti.

La politica aziendale per la qualità di **SEBA** si basa sull'efficiente evasione degli ordini, sul rispetto dei tempi di consegna, sulla trasparenza nei confronti della propria rete di rivenditori, sul massimo supporto post-vendita per soddisfare le esigenze tecniche legate all'utilizzo dei prodotti **SEBA**.

L'esperienza che **SEBA** ha maturato nella produzione di dispositivi di sicurezza le permette di garantire costantemente un servizio di elevata qualità verso la propria clientela, grazie all'affidabilità dei dispositivi e alla puntualità delle consegne. Partendo dallo studio approfondito delle specifiche esigenze degli utenti finali **SEBA** è in grado di offrire un sistema di soluzioni combinate, altamente personalizzate dal punto di vista tecnico/funzionale, del confezionamento e dei particolari serigrafici. A questo si deve aggiungere una completa conoscenza relativa alle disposizioni in materia di protezione individuale, che consente di fornire una consulenza specifica ai propri rivenditori e alle imprese partner. Il catalogo **SEBA** conta ben oltre 7000 referenze.

## CATALOGO PRODOTTI

Si tratta di dispositivi per una sicurezza globale a misura di utente: guanti, calzature, abbigliamento, equipaggiamenti anticaduta, dispositivi di protezione occhi, udito e vie respiratorie. Le recenti normative europee sull'adeguamento dei prodotti e dei sistemi di sicurezza all'interno delle industrie hanno determinato un adeguamento dell'offerta, evidente nell'ultimo catalogo presentato.

### SITO

Da alcuni anni **SEBA** ha deciso di investire sulle nuove tecnologie e di presentarsi sulla rete con un proprio sito, [www.sebagroup.eu](http://www.sebagroup.eu), con l'intento di creare una vetrina virtuale complementare al proprio catalogo e per sviluppare uno strumento di comunicazione diretto, per accompagnare i propri clienti ed i propri rivenditori nelle scelte di acquisto e nel servizio post-vendita.

[www.sebagroup.eu](http://www.sebagroup.eu)

### CODICI A BARRE

Ogni referenza **SEBA** è associata ad un codice a barre EAN 13. I codici, riportati sul presente catalogo, permettono al cliente che sia in possesso di un programma idoneo, di gestire tutte le informazioni del caso tramite pistola a lettura ottica. Questa possibilità è particolarmente importante nella vendita a banco mediante il nostro catalogo.





SEBA

# DISPOSITIVI DI PROTEZIONE INDIVIDUALE

SEBA

## DISPOSITIVI DI PROTEZIONE INDIVIDUALE - NORME CE

### DEFINIZIONE DI DPI

Dipositivo destinato ad essere indossato o tenuto dal lavoratore allo scopo di proteggerlo da uno o più rischi suscettibili di minacciarne la sicurezza e la salute durante il lavoro, nonché ogni complemento o accessorio destinato a tale scopo (vedi art.74 D.Lvo n° 81 del 09 aprile 2008).

Non sono dispositivi di protezione individuale:

- 1) gli indumenti da lavoro ordinari e uniformi non specificatamente destinati a proteggere la sicurezza e la salute del lavoratore;
- 2) le attrezzature dei servizi di soccorso e salvataggio;
- 3) le attrezzature di protezione individuale delle forze armate, delle forze di polizia e del personale del servizio per il mantenimento dell'ordine pubblico;
- 4) le attrezzature di protezione individuale proprie dei mezzi di trasporto stradali;
- 5) i materiali sportivi;
- 6) i materiali per l'autodifesa e per la dissuasione;
- 7) gli apparecchi portatili per individuare e segnalare rischi e fattori nocivi.

### REQUISITI DEI DPI (ART.76 D.LVO N° 81)

I DPI devono essere:

- 1) conformi alle norme di cui al decreto legislativo 4 dicembre 1992 n° 475;
- 2) adeguati ai rischi da prevenire, senza comportare di per sé un rischio maggiore;
- 3) adeguati alle condizioni esistenti sul luogo di lavoro;
- 4) tenere conto delle esigenze ergonomiche o di salute del lavoratore;
- 5) poter essere adattati all'utilizzatore secondo le sue necessità;
- 6) tra loro compatibili, in caso di rischi multipli che richiedono l'uso simultaneo di più DPI, e tali da mantenere, anche nell'uso simultaneo, la propria efficacia nei confronti del rischio e dei rischi corrispondenti.

### CERTIFICAZIONE CE (D.LVO 4.12.1992 N° 475 E D.LVO 2.1.1997 N° 10)

Tutti i DPI devono essere sottoposti alle procedure di certificazione previste nei rispettivi decreti legislativi (decreti di recepimento della direttiva europea 89/686/CEE e sue modifiche).

La procedura di certificazione CE impone al fabbricante l'assunzione della responsabilità di garantire che il DPI "possiede i requisiti essenziali di salute e di sicurezza" previsti nell'allegato II del D.Lvo n° 475.

La certificazione CE presuppone la suddivisione dei DPI in 3 categorie in funzione dei tipi di rischio da cui proteggono e prevede le modalità sotto elencate.

#### 1ª Categoria

Dispositivi di protezione individuale di semplice progettazione per rischi di lieve entità; il sistema di certificazione consiste in una semplice dichiarazione di conformità rilasciata dal costruttore sotto la propria responsabilità (autocertificazione).

#### 2ª Categoria

Dispositivi di protezione individuale per rischi che non rientrano nelle altre due categorie; il sistema di certificazione prevede un'attestazione CE rilasciata da un organismo notificato (solo in fase di progettazione del DPI).

#### 3ª Categoria

Dispositivi di protezione individuale di progettazione complessa contro rischi di morte, lesioni gravi o a carattere permanente; il sistema di certificazione consiste in un'attestazione CE rilasciata da un organismo notificato con controllo annuale del prodotto o sotto forma di "Controllo del prodotto finito" o come "Controllo del sistema qualità" (a scelta del costruttore).

### MARCATURA DEL DPI - MARCATURA CE

E' una marcatura obbligatoria per legge e deve comparire su ogni DPI.

Da 1° gennaio 1997 la marcatura CE è così composta:

- 1ª Categoria - CE
- 2ª Categoria - CE
- 3ª Categoria - CE0302

La marcatura può non comparire sul DPI solamente se si può dimostrare che la stessa può compromettere i requisiti di salute e di sicurezza o se la superficie disponibile non è sufficiente allo scopo.

In questo caso la marcatura CE deve essere apposta sulla confezione più prossima al DPI.

Oltre alla marcatura CE, tutti i DPI devono riportare una adeguata marcatura che deve contenere almeno:

- 1) nome, marchio o altro sistema di riconoscimento del costruttore;
- 2) riferimento al modello;
- 3) se del caso, taglia o misura;
- 4) se del caso, istruzioni particolari, pittogrammi, riferimenti a norme applicate, ecc.

### OBBLIGHI DEL DATORE DI LAVORO (ART. 77 D.LVO N° 81)

Il datore di lavoro deve scegliere il DPI più idoneo alle proprie esigenze ricercando sul mercato quanto di meglio ci possa essere in funzione delle caratteristiche e dei requisiti necessari per provvedere a un'adeguata protezione dei lavoratori. Ai fini della scelta deve:

- 1) effettuare l'analisi e la valutazione dei rischi che non possono essere evitati con altri mezzi;
- 2) individuare le caratteristiche dei DPI necessarie affinché questi siano adeguati ai rischi identificati nella valutazione tenendo conto delle eventuali ulteriori fonti di rischio rappresentate dagli stessi DPI;
- 3) valutare, sulla base delle informazioni a corredo dei DPI fornite dal fabbricante e delle norme d'uso, le caratteristiche dei DPI disponibili sul mercato e raffrontarle con quelle individuate nel punto 2;
- 4) aggiornare la scelta ogni qualvolta intervenga una variazione significativa negli elementi di valutazione;
- 5) individuare le condizioni in cui un DPI deve essere usato, specie per quanto riguarda la durata dell'uso, in funzione dell'entità del rischio, della frequenza dell'esposizione al rischio, delle caratteristiche del posto di lavoro di ciascun lavoratore e delle prestazioni del DPI.

Ai fini della gestione dei DPI deve:

- 1) fornire ai lavoratori i DPI conformi ai requisiti previsti all'articolo 42 e dal decreto di cui all'articolo 45 comma 2 (marcatura CE con relativo possesso dei requisiti essenziali di salute e di sicurezza);
- 2) mantenere in efficienza i DPI e assicurarne le condizioni di igiene, mediante la manutenzione, le riparazioni e le sostituzioni necessarie;
- 3) provvedere affinché i DPI siano utilizzati soltanto per gli usi previsti, salvo casi specifici ed eccezionali, conformemente alle informazioni del fabbricante;
- 4) fornire istruzioni comprensibili per i lavoratori;
- 5) destinare ogni DPI ad un uso personale e, qualora le circostanze richiedano l'uso di uno stesso DPI da parte di più persone, prendere misure adeguate affinché tale uso non ponga alcun problema sanitario e igienico ai vari utilizzatori.
- 6) informare preliminarmente il lavoratore da quali rischi il DPI lo protegge;
- 7) rendere disponibile in azienda e nell'unità produttiva informazioni adeguate su ogni DPI;
- 8) assicurare una formazione adeguata e organizzare, se necessario, uno specifico addestramento circa l'uso corretto e l'utilizzo pratico dei DPI.

L'addestramento è richiesto obbligatoriamente:

- A) per ogni DPI che, ai sensi del decreto legislativo 4 dicembre 1992 n° 475, appartenga alla terza categoria (rischi di morte, lesioni gravi o a carattere permanente);
- B) per i dispositivi di protezione dell'udito.

### OBBLIGHI DEI LAVORATORI (ART. 78 D.LVO N° 81)

Da parte dei lavoratori che impiegano i DPI è richiesto obbligatoriamente di:

- 1) sottoporsi al programma di formazione e addestramento organizzato dal datore di lavoro nei casi ritenuti necessari ai sensi dell'art. 43, commi 4 lett. g) e 5;
- 2) utilizzare i DPI messi loro a disposizione conformemente all'informazione e alla formazione ricevute e all'addestramento eventualmente organizzato;
- 3) aver cura dei DPI messi loro a disposizione;
- 4) non apportare modifiche ai DPI di propria iniziativa;
- 5) seguire, al termine dell'utilizzo, le procedure aziendali in materia di riconsegna del DPI;
- 6) segnalare immediatamente al datore di lavoro o al dirigente o al preposto qualsiasi difetto o inconveniente da essi rilevato nei DPI messi a loro disposizione.



## ELENCO DELLE NORME RICHIAMATE NEL CATALOGO

### INDUMENTI

EN 340:2003 Indumenti di protezione - requisiti generali  
 EN 471:2003+A1:2007 Indumenti di segnalazione ad alta visibilità per uso professionale - metodi di prova e requisiti  
 EN 470-1:95 Indumenti di protezione saldatura e processi connessi - Requisiti generali  
 EN 531:95 Indumenti di protezione per lavoratori dell'industria esposti al calore (esclusi Vigili del Fuoco e saldatori)  
 EN ISO 11611:2007 Indumenti di protezione utilizzati per la saldatura e i procedimenti connessi  
 EN ISO 11612:2008 Indumenti di protezione - Indumenti di protezione contro il calore e la fiamma  
 prEN 13034:2005+A1:2009 Indumenti di protezione contro agenti chimici liquidi - Requisiti prestazionali per indumenti di protezione chimica che offrono una protezione limitata contro agenti chimici liquidi (equipaggiamento tipo 6 e PB [6])  
 EN 1149-1:2006 Indumenti di protezione - Proprietà elettrostatiche - Parte 1: Metodo di prova per la misurazione della resistività di superficie  
 EN 1149-2:1997 Indumenti di protezione - Proprietà elettrostatiche - Metodo di prova per la misurazione della resistenza elettrica attraverso un materiale (resistenza verticale)  
 EN 1149-3:2004 Indumenti di protezione - Proprietà elettrostatiche - Parte 3: Metodi di prova per la misurazione dell'attenuazione della carica  
 EN 510:93 Specifiche per indumenti di protezione da utilizzare in presenza di rischio impigliamento con parti in movimento  
 EN 343:2003+A1:2007+AC:2009 Indumenti di protezione - Protezione contro la pioggia Scarpe e stivali  
 EN 20344:2004+A1:2007+AC:2005 Dispositivi di protezione individuale - Metodi di prova per calzature  
 EN 20345:2004+A1:2007+AC:2007 Dispositivi di protezione individuale - Calzature di sicurezza  
 EN 20346:2004+A1:2007+AC:2007 Dispositivi di protezione individuale - Calzature di protezione  
 EN 20347:2004+A1:2007+AC:2007 Dispositivi di protezione individuale - Calzature da lavoro

### OCCHIALI E VISIERE

EN 166:2001 Protezioni personale degli occhi - Specifiche  
 EN 379:2003+A1:2009 Protezioni personale degli occhi - Filtri automatici per saldatura  
 EN 169:2002 Protezioni personale degli occhi - Filtri per la saldatura e tecniche connesse  
 EN 170:2002 Protezioni personale degli occhi - Filtri ultravioletti - Requisiti di trasmissione e utilizzazioni raccomandate  
 EN 171:2002 Protezioni personale degli occhi - Filtri infrarossi - Requisiti di trasmissione e utilizzazioni raccomandate  
 EN 1731:2006 Protezioni personale degli occhi - Protettori degli occhi e del viso a rete  
 Protezione delle vie respiratorie  
 EN 132:1998 Apparecchi di protezione delle vie respiratorie - Definizione dei termini e dei pittogrammi  
 EN 134:1998 Apparecchi di protezione delle vie respiratorie - Nomenclatura dei componenti  
 EN 136:98 Apparecchi di protezione delle vie respiratorie - Maschere intere - Requisiti prove e marcatura

EN 137:2006 Dispositivi di protezione delle vie respiratorie - Autorespiratori a circuito aperto ad aria copressa con maschera intera - Requisiti, prove, marcatura  
 EN 140:1998+AC:1999 Apparecchi di protezione delle vie respiratorie - Semimaschere e quarti di maschera - Requisiti, prove, marcatura  
 EN 14387:2004+AC:2008 Dispositivi di protezione delle vie respiratorie - Filtri antigas e filtri combinati - Requisiti, prove, marcatura  
 EN 143:2000+A1:2006+AC:2022+AC:2005 Apparecchi di protezione delle vie respiratorie - Filtri antipolvere - Requisiti, prove, marcatura  
 EN 148-3:99 Apparecchi di protezione delle vie respiratorie - Filettature per facciali - Raccordo filettato M45x3  
 EN 148-1:99 Apparecchi di protezione delle vie respiratorie - Filettature per facciali - Raccordo filettato normalizzato  
 EN 149:2001+A1:2009 Dispositivi di protezione delle vie respiratorie - Semimaschere filtranti antipolvere - Requisiti, prove, marcatura  
 EN 405:2001+A1:2009 Dispositivi di protezione delle vie respiratorie - Semimaschere filtranti antigas o antigas e antipolvere dotate di valvole - Requisiti, prove e marcatura  
 Protezione dell'udito  
 EN 352-1:2002 Protettori dell'udito - Requisiti generali - Parte 1: Cuffie  
 EN 352-2:2002 Protettori dell'udito - Requisiti generali - Parte 2: Ear plugs  
 EN 352-3:2002 Protettori dell'udito - Requisiti generali - Parte 3: Cuffie montate su elmetto di protezione per l'industria  
 EN 352-4:2007 Protettori auricolari - Requisiti di sicurezza e prove - Parte 4: Cuffie con risposta in funzione del livello sonoro  
 EN 24869-1:1992 Acustica. Protettori auricolari - Metodo soggettivo per la misura dell'attenuazione sonora  
 Docce e lavaocchi  
 D.E.:93/42/CEE Concernente dispositivi medicali. L'attuazione di questa direttiva è il D. Lgs. 24/02/1997 n.46  
 UNI 9608:1993 Lavafaccia, lavaocchi e docce di emergenza. Requisiti e installazione.  
 Anticaduta e protezione del capo  
 EN 358:1999 Dispositivi di protezione individuale per il posizionamento sul lavoro e la prevenzione delle cadute dall'alto - Cinture di posizionamento sul lavoro e di trattenuta e cordini di posizionamento sul lavoro  
 EN 361:2002 Dispositivi di protezione individuale contro le cadute dall'alto - Imbracature per il corpo  
 EN 360:2002 Dispositivi di protezione individuale contro le cadute dall'alto - Dispositivi anticaduta di tipo retrattile  
 EN 353-2:2002 Dispositivi di protezione individuale contro le cadute dall'alto - Dispositivi anticaduta di tipo guidato comprendenti una linea di ancoraggio flessibile  
 EN 355:2002 Dispositivi di protezione individuale contro le cadute dall'alto - Assorbitori di energia  
 EN 362:2004 Dispositivi di protezione individuale contro le cadute dall'alto - Connettori  
 EN ISO 1140:2004 Corde di fibra - Poliammide - Corde a 3, 4 e 8 legnoli  
 EN 795:1996+A1:2000 Protezione contro le cadute dall'alto - Dispositivi di ancoraggio - Requisiti e prove  
 EN 397:1995+A1:2000 Elmetti di protezione per l'industria

Norme guanti.....	pag. 12	Protezione Antitaglio .....	pag. 43
Guanti tutto fiore.....	pag. 16	Guanti in NBR/Nitrile .....	pag. 45
Guanti in pelle.....	pag. 19	Guranti antifreddo - Invernali.....	pag. 50
Guanti in fiore e crosta.....	pag. 20	Guanti invernali / Guanti PVC.....	pag. 52
Guanti in crosta.....	pag. 22	Guanti PVC .....	pag. 53
Guanti in crosta e tela.....	pag. 25	Guanti Monouso.....	pag. 54
Guanti in nitrile.....	pag. 28	Guanti Giardinaggio .....	pag. 56
Guanti in poliuretano .....	pag. 31	Sottoguantanti in cotone e filanca .....	pag. 59
Guanti in lattice .....	pag. 35	Sottoguantanti in cotone .....	pag. 60
Guanti in lattice/PVC .....	pag. 37	Guanti Antivibrazione e meccanici .....	pag. 63
Guanti in lattice/neoprene.....	pag. 38	Anticalore .....	pag. 64
Guanti antitaglio cat. 3/5.....	pag. 39	Guanti Mapa® .....	pag. 70
Guanti antitaglio cat. 5 .....	pag. 40	Guanti Ansell® .....	pag. 72
Guanti antitaglio cat. 2/5.....	pag. 42		

## ABBIGLIAMENTO..... PAG. 80

Norme Abbigliamento.....	pag. 82	Cappelli .....	pag. 119
Giacconi - giubbotti - gilet.....	pag. 86	Indumenti antipioggia.....	pag. 122
Giubbetti e gilet leggeri.....	pag. 98	Parannanze.....	pag. 126
Soft shell.....	pag. 105	Abiti da lavoro .....	pag. 128
Felpe - tempo libero .....	pag. 108	Alta visibilità .....	pag. 175
Polo - t-shirt .....	pag. 116		

## CALZATURE - CALZE ..... PAG. 188

Norme Calzature .....	pag. 190	Calzature con puntale e lamina in acciaio.....	pag. 220
Calzature con punta e soletta antiforo in composito .....	pag. 193	Calzature con punta acciaio lamina tessuto.....	pag. 221
Calzature con punta in acciaio e soletta tessile antiforo .....	pag. 199	Calzature con puntale rinforzato e soletta antiforo.....	pag. 222
Calzature con punta in composito e soletta tessile antiforo .....	pag. 202	Calzature con puntale in composito .....	pag. 223
Calzature con punta rinforzata e soletta antiforo.....	pag. 203	Calzature settore alimentare/sanitario.....	pag. 224
Calzature con punta e soletta antiforo in composito .....	pag. 204	Zoccoli .....	pag. 227
Calzature con punta e soletta antiforo .....	pag. 207	Calzature no Safety.....	pag. 228
Calzature con punta e lamina in composito.....	pag. 208	Zoccoli .....	pag. 229
Calzature con punta in composito e soletta antiforo .....	pag. 208	Stivali .....	pag. 232
Calzature con punta e soletta antiforo in composito .....	pag. 209	Sottopiedi .....	pag. 244
Calzature con puntale rinforzato e lamina antiforo .....	pag. 215	Calze .....	pag. 246
Calzature con puntale acciaio e soletta tessile antiforo .....	pag. 216		
Calzature con punta rinforzata e soletta antiforo.....	pag. 217		
Calzature con punta acciaio lamina antiforo .....	pag. 218		

## ARTICOLI DI SETTORE ..... PAG. 248

Articoli per operatori forestali con uso di motosega .....	pag. 250
Articoli per imbianchini e operatori smaltimento amianto.....	pag. 254
Articoli per saldatori.....	pag. 264
Articoli settore alimentare e macelli .....	pag. 276

# ELMETTI - LAMPADE - UDITO - VISTA - RESPIRATORIE ..... PAG. 298

ELMETTI-LAMPADE .....	pag. 301
Elmetti .....	pag. 302
Lampade .....	pag. 303
Visiere .....	pag. 303

PROTEZIONE UDITO .....	pag. 304
Elmetti con cuffie antirumore .....	pag. 305
Cuffie Antirumore .....	pag. 306
Tappi antirumore .....	pag. 306

PROTEZIONE VISTA .....	pag. 308
Norme protezione vista .....	pag. 310
Occhiali .....	pag. 310

PROTEZIONE RESPIRATORIA .....	pag. 316
Norme protezione vie respiratorie .....	pag. 318
Facciali Filtranti .....	pag. 321
Facciali Filtranti - Semimaschere BLS .....	pag. 322
Semimaschere BLS .....	pag. 323
Pieno Facciali BLS .....	pag. 324
Semimaschere .....	pag. 324

3M .....	pag. 325
Facciali Filtranti 3M .....	pag. 328
Maschere - Semimaschere 3M .....	pag. 329
Facciali filtranti 3M .....	pag. 330
Filtri 3M .....	pag. 330
Protezione udito 3M .....	pag. 334

# ARTICOLI ANTICADUTA ..... PAG. 336

Norme sistemi anticaduta .....	pag. 338
--------------------------------	----------

ARTICOLI ANTICADUTA .....	pag. 342
Imbragature .....	pag. 344
Cordini - Assorbitori .....	pag. 346
Accessori .....	pag. 348
Moschettoni .....	pag. 349
Cavalletto - Argano .....	pag. 349

SOLUZIONI ANTICADUTA .....	pag. 350
per coperture .....	pag. 352
per ponteggi .....	pag. 354
per lavorazioni in altezza con cestello .....	pag. 355
per lavorazioni in altezza su alberi .....	pag. 355

FASCE DI SOLLEVAMENTO - CRICCHETTI .....	pag. 356
Normativa .....	pag. 356
Tiranti in poliestere .....	pag. 357
Funi tonde .....	pag. 357
Dispositivi di ancoraggio .....	pag. 357

# ARTICOLI DA CANTIERE ..... PAG. 358

Articoli da cantiere .....	pag. 360
Segnaletica .....	pag. 366
Specchi stradali .....	pag. 370
Cinture borse portattrezzi .....	pag. 371
Accessori attrezzi .....	pag. 372
Dossi stradali .....	pag. 374
Segnaletica stradale .....	pag. 375
Nastri cantieri .....	pag. 376

Filo per l'edilizia .....	pag. 378
Linea bombolette spray e vernici .....	pag. 379
Traccialinee .....	pag. 384
Cassette pronto soccorso .....	pag. 385

# MANUTENZIONE ..... PAG. 390

Linea manutenzione .....	pag. 392
Docce lavaocchi .....	pag. 407
Settore ospedaliero .....	pag. 410

Autotrasportatori .....	pag. 411
Espositori - Accessori esposizione .....	pag. 412

# INDICE

Norme guanti .....	pag. 12	Guanti antitaglio cat. 2/5 .....	pag. 42
Guanti tutto fiore .....	pag. 16	Protezione Antitaglio .....	pag. 43
Guanti in pelle .....	pag. 19	Guanti in NBR/Nitrile.....	pag. 45
Guanti in fiore e crosta.....	pag. 20	Guanti antifreddo - Invernali.....	pag. 50
Guanti in crosta .....	pag. 22	Guanti invernali / Guanti PVC.....	pag. 52
Guanti in crosta e tela.....	pag. 25	Guanti PVC.....	pag. 53
Guanti in nitrile .....	pag. 28	Guanti Monouso .....	pag. 54
Guanti in poliuretano .....	pag. 31	Guanti Giardinaggio.....	pag. 56
Guanti in lattice.....	pag. 35	Sottoguanti in cotone e filanca.....	pag. 59
Guanti in lattice/PVC.....	pag. 37	Sottoguanti in cotone.....	pag. 60
Guanti in lattice/neoprene.....	pag. 38	Guanti Antivibrazione e meccanici.....	pag. 63
Guanti antitaglio cat. 3/5 .....	pag. 39	Anticalore.....	pag. 64
Guanti antitaglio cat. 5 .....	pag. 40	Guanti Mapa® .....	pag. 70
		Guanti Ansell® .....	pag. 72



SEBA



# GUANTI GLOVES



## Normative EN

### EN 420 Requisiti generali e metodi di prova

La norma definisce i requisiti generali e i corrispondenti procedimenti di prova per la progettazione e la fabbricazione dei guanti, la resistenza dei materiali dei guanti alla penetrazione dell'acqua, l'innocuità (valore di pH entro range 3,5 - 9,5, contenuto di Cromo VI < 3 ppm, contenuto proteine estraibili), la confortevolezza e l'efficienza (taglie, destrezza, permeabilità e assorbimento del vapore acqueo), la marcatura e le informazioni fornite dal fabbricante applicabili a tutti i guanti di protezione. Il guanto è un prodotto per la salvaguardia individuale che protegge la mano e le varie parti della mano. Il guanto potrebbe inoltre coprire parte dell'avambraccio e del braccio. L'indice di prestazione, indicato normalmente da un numero tra 0 e 4 (5 nel caso del taglio), riflette il comportamento del guanto ad una determinata prova. Tale graduatoria consente quindi di classificare i risultati della prova. Il livello 0 indica che il guanto non è stato provato o che non ha raggiunto i requisiti minimi. Un livello di prestazione X indica che il metodo di prova non è adatto al campione di guanto testato. Ad un numero alto corrisponde normalmente un alto livello di prestazione.

### EN 374 Guanti di protezione contro prodotti chimici e microorganismi

- **EN 374 -1.** La norma specifica i requisiti dei guanti destinati a proteggere l'utilizzatore contro prodotti chimici e/o microorganismi e definisce i termini da utilizzare. Essa deve essere utilizzata unitamente alla UNI EN 420. La norma non specifica i requisiti per la protezione contro i pericoli meccanici.

- **EN 374 -2.** La norma specifica un metodo di prova per la resistenza alla penetrazione di guanti di protezione contro prodotti chimici e/o microorganismi. Definizione: per penetrazione s'intende il passaggio di una sostanza chimica o di un micro-organismo attraverso la porosità dei materiali, le cuciture, eventuali microforature o altre imperfezioni del guanto di protezione a livello non molecolare; Requisiti: un guanto non deve presentare perdite se sottoposto a prove di tenuta all'aria e all'acqua e dev'essere testato e controllato in conformità con il livello di qualità accettabile (AQL).

INDICE DI PRESTAZIONE	LIVELLO DI QUALITÀ ACCETTABILE (AQL)	LIVELLO D'ISPEZIONE
Livello 3	< 0,65	G1
Livello 2	< 1,5	G4
Livello 1	< 4,0	S4



### Pittogramma

Viene apposto se il guanto è conforme almeno ai livelli di prestazione 2 della prova di penetrazione.

a b c

- **EN 374-3.** La norma specifica la determinazione della resistenza dei materiali dei guanti di protezione alla permeazione dei prodotti chimici non gassosi potenzialmente pericolosi in condizioni di contatto continuo.

- **Definizione:** per permeazione s'intende il passaggio di una sostanza chimica attraverso il materiale del guanto di protezione a livello molecolare; e pertanto necessario misurare il tempo di permeazione o il tempo impiegato dal liquido per venire a contatto con la pelle.

- **Requisiti:** l'impermeabilità del guanto dev'essere garantita almeno per la lunghezza minima del guanto prevista dalla norma EN 420. Si considera un guanto resistente ai prodotti chimici se si ottiene un indice di protezione in Classe 2 per almeno tre prodotti chimici di prova scelti dalla seguente lista di 12 sostanze chimiche predefinite:

CODICE LETTERA	SOSTANZA CHIMICA	NUMERO CAS	CLASSE
A	Metanolo	67-56-1	Alcol primario
B	Acetone	67-64-1	Chetone
C	Acetonitrile	75-05-8	Composto di nitrile
D	Diclorometano	75-09-2	Paraffina clorurata
E	Bisolfuro di carbonio	75-15-0	Zolfo contenente composto organico
F	Toluene	108-88-3	Idrocarburo aromatico
G	Dietilammina	109-89-7	Ammine
H	Tetraidrofurano	109-99-9	Composto di etere ed eterociclico
I	Acetato di etile	141-78-6	Estere
L	Acido solforico 96%	7664-93-9	Acido minerale inorganico



**Permeazione: ogni sostanza chimica testata viene classificata in termini di tempo di permeazione (indice di prestazione da 0 a 6).**

TEMPO DI PERMEAZIONE MISURATO	INDICE DI PROTEZIONE	TEMPO DI PERMEAZIONE MISURATO	INDICE DI PROTEZIONE
< 10 minuti	Classe 1	< 120 minuti	Classe 4
< 30 minuti	Classe 2	< 240 minuti	Classe 5
< 60 minuti	Classe 3	< 480 minuti	Classe 6



## Pittogramma - Protezione Chimica Specifica

Viene apposto, seguito da un codice di almeno tre caratteri, se il guanto ottiene un tempo di permeazione di almeno 30 min ad almeno tre prodotti chimici di prova.



## Pittogramma - Protezione Chimica Generica

Viene apposto se il guanto NON ottiene un tempo di permeazione di almeno 30 min ad almeno tre prodotti chimici di prova, ma conforme alla prova di penetrazione.



## Pittogramma - Micro Organismi

Il pittogramma "Microorganismi" viene apposto se il guanto è conforme almeno alle specifiche di prestazione 2 della prova di Penetrazione.



## Pittogramma -Radiazioni ionizzanti e contaminazione radioattiva

Per proteggere dalla contaminazione radioattiva, il guanto deve essere impermeabile e deve superare la prova di penetrazione prevista dalla norma EN 374.

## EN 388 Guanti di protezione contro rischi meccanici

La norma specifica i requisiti, i metodi di prova, la marcatura e le informazioni fornite dal fabbricante per i guanti di protezione contro rischi meccanici da abrasione, taglio da lama, lacerazione e perforazione.

Definizione: la protezione dai pericoli di natura meccanica è rappresentata da un pittogramma seguito da quattro numeri (indici di prestazione), ciascuno dei quali indica il livello di prestazione del guanto rilevato dalla prova per un determinato rischio.

Requisiti:

- a** Resistenza all'abrasione: indicata dal numero di cicli richiesti per abradere completamente il guanto di prova
- b** Resistenza al taglio (da lama): indicata da un fattore calcolato sul numero di passaggi necessari per tagliare il guanto di prova a velocità costante
- c** Resistenza allo strappo: indica la forza necessaria per lacerare il provino
- d** Resistenza alla perforazione: indica la forza necessaria per perforare il provino con una punta di dimensioni standard ndr nei quattro casi, lo zero indica il livello più basso di protezione come illustrato nella seguente tabella

INDICI DI PRESTAZIONE	0	1	2	3	4	5
a Resistenza all'abrasione (cicli)	<101	100	500	2000	8000	-
b Resistenza al taglio (fattore)	< 1.2	1.2	2.5	5.0	10.0	20.0
c Resistenza allo strappo (newton)	< 10	10	25	50	75	-
d Resistenza alla perforazione (newton)	< 20	20	60	100	150	-



- a: resistenza all'abrasione (0-4)**
- b: resistenza al taglio da lama (0-5)**
- c: resistenza allo strappo (0-4)**
- d: resistenza alla perforazione (0-4)**

## EN 407 Guanti di protezione contro rischi termici

La norma specifica requisiti, metodi di prova, informazioni da fornire e marcatura dei guanti di protezione contro calore e/o fuoco. Definizione e requisiti: la natura e il grado di protezione vengono indicati da un pittogramma seguito da una serie di sei cifre che precisano il livello di prestazione per le relative condizioni di rischio descritte nella tabella seguente:

DESCRIZIONE	LIVELLO 1	LIVELLO 2	LIVELLO 3	LIVELLO 4
<b>a. Comportamento al fuoco</b>				
Persistenza fiamma (secondi)	≤ 20	≤ 20	≤ 3	≤ 2
Incandescenza (secondi)	-	≤ 120	≤ 25	≤ 5
<b>b. Calore per contatto</b>				
Temperatura di contatto (°C)	100	250	350	500
Tempo di soglia (secondi)	≤ 15	≤ 15	≤ 15	≤ 15
<b>c. Calore convettivo</b>				
(indice HTI)	< 4	< 7	< 10	< 18
<b>d. Calore radiante</b>				
Trasmissione di calore f (secondi)	≤ 5	≤ 30	≤ 90	≤ 150
<b>e. Piccoli spruzzi di metallo fuso</b>				
(goccioline)	≤ 5	≤ 15	≤ 25	≤ 36
<b>f. Grandi proiezioni di metallo fuso</b>				
Ferro fuso (grammi)	30	60	120	200

Nota: "0" = il guanto non ha superato il test / "X" = il guanto non è stato provato



a b c

### Pittogramma

## EN 12477 Guanti di protezione per saldatura

La norma specifica requisiti e metodi di prova per guanti di protezione da utilizzare nella saldatura manuale dei metalli, nel taglio e nei procedimenti connessi. E' prevista una classificazione in due tipi:

**Tipo B:** quando è richiesta elevata destrezza (es operazioni di saldatura TIG)

**Tipo A:** per gli altri processi di saldatura



a b c

### Pittogramma

## EN 1149 Indumenti di protezione. Proprietà elettrostatiche

La norma specifica requisiti e metodi di prova relativi ai materiali utilizzati nella produzione dell'abbigliamento (guanti) protettivo per la dissipazione delle scariche elettrostatiche.



a b c

### Pittogramma

## EN 511 Guanti di protezione contro il freddo

La norma specifica requisiti e metodi di prova per guanti che proteggono contro il freddo trasmesso per convezione o conduzione fino a -50°C. Definizione e requisiti: la protezione dal freddo è rappresentata da un pittogramma seguito da una serie di 3 indici di prestazioni, relativi alle proprietà di protezione specifiche.

INDICAZIONI DI PRESTAZIONE	a	b	c
	<b>Freddo convettivo</b> Isolazione termica I <sub>tr</sub> in m <sup>2</sup> C/w	<b>Freddo da contatto</b> Resistenza termica R in m <sup>2</sup> C/w	<b>Impermeabilità all'acqua</b>
0	I <sub>tr</sub> < 0,10	R < 0,025	nullo
1	0,10 < I <sub>tr</sub> < 0,15	0,025 < R < 0,050	promosso
2	0,15 < I <sub>tr</sub> < 0,22	0,050 < R < 0,100	
3	0,22 < I <sub>tr</sub> < 0,30	0,100 < R < 0,150	
4	0,30 < I <sub>tr</sub>	0,150 < R	

Nota: "0" = il guanto non ha superato il test / "X" = il guanto non è stato provato





# SETTORI DI UTILIZZO

	INDUSTRIA ALIMENTRE RISTORAZIONE
	ANTITAGLIO
	ANTIFIAMMA RESISTENZA AL CALORE
	CANTIERI NAVALI
	INDUSTRIA CHIMICA FARMACEUTICA
	CANTIERI E LAVORI EDILI
	INDUSTRIA ELETTRONICI ELETTRICISTI

	RESISTENZA A BASSE TEMPERATURE
	AGRICOLTURA GIARDINAGGIO
	INDUSTRIA
	LAVORAZIONI PESANTI
	CANTIERI STRADALI
	MAGAZZINO
	MECCANICA

	OFFICINA MECCANICA
	LAVORI DI PRECISIONE
	PULIZIE
	SALDATURA
	TEMPO LIBEO
	TRASPORTI
	TAGLIE

# PITTOGRAMMI - CONFEZIONI - MATERIALI

	RISCHI MECCANICI
	ELETTRICITÀ STATICA
	RISCHI CHIMICI
	CALORE / FIAMMA
	RISCHI DA MICROORGANISMI
	RISCHI FREDDO
	USO ALIMENTARE
	RISCHI DA TAGLIO

	CONFEZIONE CARTONCINO APPENDIBILE
	CONFEZIONE BUSTA APPENDIBILE
	SCATOLA 50 PEZZI
	SCATOLA 100 PEZZI
	CONFEZIONE 5 PAIA
	CONFEZIONE 10 PAIA
	CONFEZIONE 12 PAIA

<b>POWDER</b>	POLVERE INTERNA
<b>NO POWDER</b>	SENZA POLVERE
<b>NITRILE</b>	NITRILE
<b>STRONG LATEX</b>	LATTICE DOPPIO SPESSORE
<b>LATEX</b>	LATTICE
	IMPERMEABILE



Distributore Autorizzato



art. 8 RF

[EN388 2132]



CE

2132



TOP QUALITY



Guanto in pieno fiore bovino - QUALITA' TOP - con rinforzo al pollice.

**Taglie:** 10

**Applicazione:** edilizia, industria, agricoltura.

**Packing:** 10 paia

**Imballo minimo per ordine:** 120 paia

**Scatola:** 120 paia - volume m<sup>3</sup> 0,08 - peso kg. 9

**Articolo dotato di codice a barre**



10

art. 8 CE

[EN388 2132]



CE

2132



Guanto fiore bovino bordato, colore naturale, spessore del pellame da mm 0,8 a mm 1,1 - Grado A

**Applicazione:** edilizia, industria, agricoltura, magazzini.

**Taglie:** 7-8-9-10-11

**Packing:** 10 paia

**Imballo minimo per ordine:** 60 paia

**Scatola:** 60 paia - volume m<sup>3</sup> 0,08 - peso kg. 7

**Articolo dotato di codice a barre e cartoncino espositore.**



7-11

## art. 8 CE2

[EN388 2132]



2132



10

CE



Guanto fiore bovino orlato – Grado B

**Applicazione:** edilizia, industria, agricoltura, magazzini.

**Taglie:** 7- 8- 9- 10- 11

**Packing:** 10 paia

**Imballo minimo per ordine:** 60 paia

**Scatola:** 60 paia - volume m<sup>3</sup> 0,08 - peso kg. 10

**Articolo dotato di codice a barre**



7

8 011818 114577



8

8 011818 106459



9

8 011818 106466



10

8 011818 106473



11

8 011818 106480



7-11

## art. 30A7

[EN 388 4233 - EN 407 - 412X4X]



4233



412X4X



12

CE



Guanto completamente in pieno fiore bovino idrorepellente. Con salvacuciture in pelle, palmo, pollice e paranocche rinforzate. Interno totalmente foderato in flanella. Cuciture totalmente in kevlar.

Manichetta da cm. 8 in fiore bovino.

**Taglia:** UNICA 10

**Applicazione:** lavorazioni pesanti, saldatura, cantieri navali.

**Packing:** 12 paia

**Imballo minimo per ordine :** 60 paia

**Scatola:** 60 paia - volume m<sup>3</sup> 0,10 - peso kg. 7

**Articolo dotato di codice a barre**



UNICA 10

8 011818 143355



UNICA 10

## art. 30A8

[EN 388 4233 - EN 407 - 412X4X - EN 12477 +A1: 2005 ]



4233



412X4X



12

CE



Guanto completamente in pieno fiore bovino idrorepellente. Con salvacuciture in pelle, palmo, pollice e paranocche rinforzate. Interno totalmente foderato in flanella. Cuciture totalmente in kevlar.

Manichetta da cm. 15 in fiore bovino.

**Taglia:** UNICA 10

**Applicazione :** lavorazioni pesanti, saldatura, cantieri navali.

**Packing:** 12 paia

**Imballo minimo per ordine :** 60 paia

**Scatola:** 60 paia - volume m<sup>3</sup> 0,10 - peso kg. 10

**Articolo dotato di codice a barre**



UNICA 10

8 011818 143362



UNICA 10

art. 4 RF

[EN388 3144]

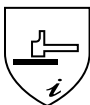

CE

3144



Guanto in fiore bovino totalmente rinforzato su palmo, pollice e tutte le dita. Manichetta crosta da cm 8

**Applicazione:** edilizia, industria, agricoltura, magazzini.

**Taglia:** 10

**Packing:** 10 paia

**Imballo minimo per ordine:** 60 paia

**Scatola:** 60 paia - volume m<sup>3</sup> 0,10 - peso kg. 11

**Articolo dotato di codici a barre**



UNICA

art. 4 TFL

[EN388 3144]

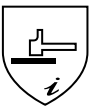

CE

3144



Guanto in fiore totalmente rinforzato su palmo, pollice e tutte le dita. Manichetta crosta da cm 15

**Applicazione:** edilizia, industria, agricoltura, magazzini.

**Taglie:** 10

**Packing:** 10 paia

**Imballo minimo per ordine:** 60 paia

**Scatola:** 60 paia - volume m<sup>3</sup> 0,10 - peso kg. 12

**Articolo dotato di codice a barre**



UNICA

art. 40R

[EN388 1121]



CE

1121



Guanto in fiore cinghiale e dorso a maglia e paraunghie - c/polsino regolabile

**Applicazione:** edilizia, magazzinaggio, officina.

**Taglie:** 7-8-9-10-11

**Packing:** 12 paia

**Imballo minimo per ordine:** 120 paia

**Scatola:** 120 paia - volume m<sup>3</sup> 0,15 - peso kg. 10

**Articolo dotato di codice a barre e cartoncino espositore**

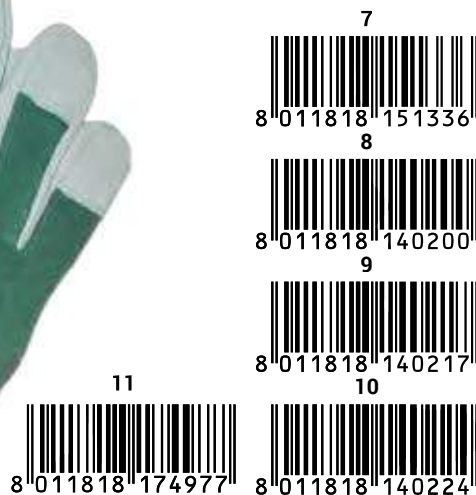

- 7
- 8
- 9
- 10
- 11

## art. 40P SC

[EN388 1121]



1121



CE

Guanto con palmo in fiore di capretto, dorso e polsino a maglia  
**Taglie:** 7 - 8 - 9 - 10  
**Applicazione:** edilizia, industria, agricoltura, magazzini.  
**Packing:** 12 paia  
**Imballo minimo per ordine:** 120 paia  
**Scatola:** 120 paia - volume m<sup>3</sup> 0,10 - peso kg.10  
**Articolo dotato di codice a barre**



7 - 10

## art. 33FA

[EN420 - CAT.1]



12

CE

Guanto in pelle. Palmo e rinforzo palmo nappa. Dorso e fodera interna in tela. Manicotto in tela.  
**Taglia:** 10  
**Applicazione:** edilizia, industria, agricoltura, magazzini.  
**Packing:** 12 paia  
**Imballo minimo per ordine:** 120 paia  
**Scatola:** 120 paia - volume m<sup>3</sup> 0,15 - peso kg. 12  
**Articolo dotato di codice a barre**



UNICA



# SEBA

art. 8 CRF

[EN388 2132]

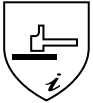

CE

2132



TOP QUALITY



Guanto con palmo in fiore, dorso in crosta bovino  
- QUALITA' TOP - con rinforzo al pollice.

**Taglie:** 10

**Applicazione:** edilizia, industria, agricoltura.

**Packing:** 10 paia

**Imballo minimo per ordine:** 120 paia

**Scatola:** 120 paia - volume m<sup>3</sup> 0,08 - peso kg. 9

**Articolo dotato di codice a barre**



10



10

art. 8 CEM

[EN388 2132]



CE

2132



Guanto con palmo in fiore bovino,  
bordato, dorso in crosta, colore  
naturale, spessore del pellame da  
mm 0,8 a mm 1,1 - grado B

**Taglie:** 8 - 9 - 10 - 11

**Applicazione:** edilizia, industria,  
agricoltura, magazzini.

**Packing:** 10 paia

**Imballo minimo per ordine:** 60 paia

**Scatola:** 60 paia - volume m<sup>3</sup> 0,10  
- peso kg. 7

**Articolo dotato di codice a barre**



8



9



10



11



8 - 11

## art. 4TFC

[EN388 2132]



2132



CE



Guanto in fiore rinforzato - dorso crosta

**Taglia:** 10

**Applicazione:** edilizia, industria, agricoltura, magazzini.

**Packing:** 10 paia

**Imballo minimo per ordine:** 60 paia

**Scatola:** 60 paia - volume m<sup>3</sup> 0,10 - peso kg. 10

**Articolo dotato di codice a barre**



UNICA

## art. 4RFC

[EN3144]



3144



CE



Guanto in fiore totalmente rinforzato - dorso crosta

**Taglia:** 10

**Applicazione:** edilizia, industria, agricoltura, magazzini.

**Packing:** 10 paia

**Imballo minimo per ordine:** 60 paia

**Scatola:** 60 paia - volume m<sup>3</sup> 0,10

peso kg. 10

**Articolo dotato di codice a barre**



UNICA

## art. 4TFLC

[EN3144]



3144



CE



Guanto in fiore totalmente rinforzato dorso crosta. Manicotto cm 15

**Taglia:** 10

**Applicazione:** edilizia, industria, agricoltura, magazzini.

**Packing:** 10 paia

**Imballo minimo per ordine:** 60 paia

**Scatola:** 60 paia - volume m<sup>3</sup> 0,15 - peso kg. 15

**Articolo dotato di codice a barre**



UNICA

art. 30A6

[EN388 3132 ]

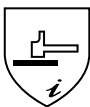

CE

3132



12



Guanto a 5 dita in pelle crosta IDROPELENTE (resistenza valore 4). Spessore ca. 1,40 mm, con pollice ad ala e rinforzo interno nel palmo e nel pollice, manichetta in crosta cm 13, bordato con fettuccia color verde- Elastico stringipolso. Totalmente cucito in filo di KEVLAR.

**Taglia:** UNICA 10

**Applicazione:** Edilizia, saldatura, carpenteria

**Packing:** 12 paia

**Imballo minimo per ordine:** 72 paia

**Scatola:** 72 paia volume m<sup>3</sup> 0,10 Kg.10

**Articolo dotato di codice a barre**



art. 30A3

[EN388 3132 ]



CE

3132



12



Guanto a 5 dita in pelle crosta IDROPELENTE (resistenza livello 4). Spessore ca. 1,40 mm, con pollice ad ala e rinforzo interno nel palmo e nel pollice, manichetta in crosta cm 7, bordato con fettuccia color verde.

Elastico stringipolso applicato sul dorso.

Totalmente cucito in filo di KEVLAR.

**Taglia:** UNICA 10

**Applicazione:** Edilizia, saldatura, carpenteria

**Packing:** 12 paia

**Imballo minimo per ordine:** 120 paia

**Scatola:** 120 paia volume m<sup>3</sup> 0,10 Kg.10

**Articolo dotato di codice a barre**





## art. 30A4

[EN388 3132]



CE

3132



12



Guanto a 5 dita in pelle crosta IDROREPELENTE (valore resistenza 4). Spessore ca. 1,4 mm, con mezza fodera interna nel palmo, con pollice ad ala, bordato con fettuccia color verde. Elastico strigipolso applicato sul dorso. Totalmente cucito in filo di KEVLAR.

**Taglia:** 10

**Applicazione:** Edilizia, saldatura, carpenteria

**Packing:** 12 paia

**Imballo minimo per ordine:** 120 paia

**Scatola:** 120 paia volume m<sup>3</sup> 0,10 Kg.10

**Articolo dotato di codice a barre**



10



## art. 30

[EN388 2133]



CE

2133



12

Guanto tutto in crosta di groppone bovino con manicotto

**Taglia:** 10

**Applicazione:** edilizia, industria, magazzini.

**Packing:** 12 paia

**Imballo minimo per ordine:** 72 paia

**Scatola:** 72 paia - volume m<sup>3</sup> 0,10 - peso kg. 10

**Articolo dotato di codice a barre**



10



## art. 32SC

[EN388 4244]



CE

4244



12

Guanto in crosta di groppone bovino, palmo rinforzato, con manicotto in crosta

**Taglia:** 10

**Applicazione:** edilizia, industria, magazzini.

**Packing:** 12 paia

**Imballo minimo per ordine:** 72 paia

**Scatola:** 72 paia - volume m<sup>3</sup> 0,10 - peso kg. 12

**Articolo dotato di codice a barre**



10



art. 32EC SC

[EN420 - CAT.1]



Guanto in crosta bovina rinforzato, economico, con manicotto

**Taglia:** 10

**Applicazione:** edilizia, industria, magazzini.

**Packing:** 12 paia

**Imballo minimo per ordine:** 72 paia

**Scatola:** 72 paia - volume m<sup>3</sup> 0,10 - peso kg. 12

**Articolo dotato di codice a barre**



UNICA

art. 49A

[EN388 4244]



4244



Guanto in crosta di groppone bovino, con manicotto crosta cm 15, rinforzato palmo e pollice

**Taglia:** 10

**Applicazione:** edilizia, industria, magazzini.

**Packing:** 12 paia

**Imballo minimo per ordine:** 72 paia

**Scatola:** 72 paia - volume m<sup>3</sup> 0,15 - peso kg. 13

**Articolo dotato di codice a barre**



UNICA

art. 30B

[EN388 4122]



4122



Guanto driver in crosta bovina orlato. **Applicazione:** edilizia, magazzinaggio, officina.

**Taglie:** 9 - 10

**Packing:** 10 paia

**Imballo minimo per ordine:** 60 paia

**Scatola:** 60 paia - volume m<sup>3</sup> 0,08 - peso kg. 9

**Articolo dotato di codice a barre**



9 - 10

## art. 49R

[EN388 2144]  
[EN407 - 413X4X]

CE

"CUCITURE IN KEVLAR"

Guanto tutto in crosta bovina anticalore, completo di salva cucitura, totalmente foderato internamente in tessuto di cotone. Colore rosso.

**Taglia:** 10

**Applicazione:** Questo articolo è particolarmente adatto alla lavorazione in saldatura e nelle lavorazioni in presenza di calore.

**Packing:** 12 paia

**Imballo minimo per ordine:** 60 paia

**Scatola:** 60 paia - volume m<sup>3</sup> 0,10 - peso kg. 10

**Articolo dotato di codice a barre**



UNICA



2144



413X4X



12

## art. 49V

[EN388 2143]

CE

Guanto tutto in crosta bovina completo di salvacucitura, totalmente foderato internamente in tessuto di cotone. Colore verde

**Taglia:** 10

**Applicazione:** industria della saldatura.

**Packing:** 12 paia

**Imballo minimo per ordine:** 60 paia

**Scatola:** 60 paia - volume m<sup>3</sup> 0,10

peso kg. 12

**Articolo dotato di codice a barre**



UNICA



2143



12

## art. 49VG

[EN388 2143]

CE

Guanto tutto in crosta bovina completo di salvacucitura, totalmente foderato internamente in tessuto di cotone. Colore grigio

**Taglia:** 10

**Applicazione:** industria della saldatura.

**Packing:** 12 paia

**Imballo minimo per ordine:** 60 paia

**Scatola:** 60 paia - volume m<sup>3</sup> 0,10 -

peso kg. 12

**Articolo dotato di codice a barre**



UNICA



2143



12

art. 34SC

[EN388 4244]

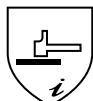

CE

4244



Guanto in crosta bovina rinforzato  
palmo, pollice e indice. Dorso in tela.  
Manichetta in canvas

**Taglia:** 10

**Applicazione:** edilizia, industria,  
magazzini.

**Packing:** 12 paia

**Imballo minimo per ordine:** 120 paia

**Scatola:** 120 paia – volume m<sup>3</sup> 0,15 –  
peso kg. 13

**Articolo dotato di codice a barre**



UNICA

art. 85PSC

[EN388 3142]

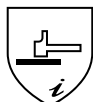

CE

3142



Guanto con palmo in crosta bovina  
rinforzato, economico, dorso e  
manicotto in tela jeans

**Taglia:** 10

**Applicazione:** edilizia, industria,  
magazzini.

**Packing:** 12 paia

**Imballo minimo per ordine:** 120 paia

**Scatola:** 120 paia – volume m<sup>3</sup> 0,15 –  
peso kg. 12

**Articolo dotato di codice a barre**



UNICA

art. 33

[EN388 2133]

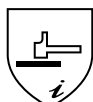

CE

2133



Guanto in crosta bovina, dorso e  
manichetta in tela.

**Applicazione:** edilizia, magazzinaggio.

**Taglie:** 10

**Packing:** 12 paia

**Imballo minimo per ordine:** 120 paia

**Scatola:** 120 paia - volume m<sup>3</sup> 0,15 -  
peso kg. 12

**Articolo dotato di codice a barre**



UNICA

## art. 10TCT

[EN388 2121]

CE

Guanto con palmo in crosta di groppone bovino, dorso e manicotto in tela, paraungchie e paranocche  
**Taglia:** 10  
**Applicazione:** edilizia, industria, agricoltura, magazzini.  
**Packing:** 12 paia  
**Imballo minimo per ordine:** 72 paia  
**Scatola:** 72 paia – volume m<sup>3</sup> 0,15 – peso kg. 13  
**Articolo dotato di codice a barre**



UNICA



2121



12

## art. 88PBS

[EN420 - CAT.1]

CE

Guanto con palmo in crosta di cinghiale, dorso e manicotto in tela  
**Taglia:** 10  
**Applicazione:** edilizia, agricoltura, magazzini.  
**Packing:** 24 paia  
**Imballo minimo per ordine:** 24 paia  
**Scatola:** 72 paia – volume m<sup>3</sup> 0,10 – peso kg. 10  
**Articolo dotato di codice a barre e cartoncino espositore**



UNICA



## art. 88PBS-SC

[EN420 - CAT.1]

CE

Guanto con palmo in crosta di cinghiale, dorso e manicotto in tela, senza cartoncino  
**Taglia:** 10  
**Applicazione:** edilizia, agricoltura, magazzini.  
**Packing:** 12 paia  
**Imballo minimo per ordine:** 120 paia  
**Scatola:** 120 paia – volume m<sup>3</sup> 0,10 – peso kg. 10  
**Articolo dotato di codice a barre**



UNICA



12

art. 500NBR-SC

[EN388 4131]



4131



CE

Guanto di qualità superiore in nylon spalmato nitrile

**Taglie:** 7 - 11

**Applicazione:** edilizia, industria, magazzinaggio

**Packing:** 12 paia

**Imballo minimo per ordine:** 240 paia

**Scatola:** 240 paia volume m<sup>3</sup> 0,09 - peso Kg. 10

**Articolo dotato di codice a barre e busta appendibile.**



M (8)



L (9)



XL (10)



S (7)



XXL (11)



7 - 11

art. 500NBR

[EN388 4131]



4131

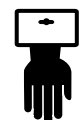

CE

Guanto di qualità superiore in nylon spalmato nitrile

**Taglie:** 7 - 11

**Applicazione:** edilizia, industria, magazzinaggio

**Packing:** 48 paia

**Imballo minimo per ordine:** 48 paia

**Scatola:** 96 paia - volume m<sup>3</sup> 0,10 - peso Kg. 10

**Articolo dotato di codice a barre e cartoncino espositore**



M (8)



L (9)



XL (10)



S (7)



XXL (11)



7 - 11

art. 500NBR-ECO

[EN388 4121]

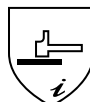

4121



CE

Guanto in nitrile spalmato su nylon. Lavabile a 40°C con detergente neutro.

**Taglie:** 6 - 7 - 8 - 9 - 10 - 11

**Applicazione:** Edilizia, industria, magazzinaggio

**Packing:** 12 paia

**Imballo minimo per ordine:** 240 paia

**Scatola:** 240 paia volume m<sup>3</sup> 0,10 Kg.10

**Articolo dotato di codice a barre e busta appendibile.**



M (8)



L (9)



XS (6)



XL (10)



S (7)



XXL (11)



6 - 11

## art. 500NS



4121



CE

Guanto in nylon spalmato in nitrile satinato "extra grip"

**Taglia:** 7-11

**Applicazione:** edilizia, industria, magazzini.

**Packing:** 12 paia

**Imballo minimo per ordine:** 240 paia

**Scatola:** 240 paia - volume m<sup>3</sup> 0,15  
Peso kg. 13

**Articolo dotato di codice a barre e busta appendibile**



[EN 388 4121]



7 - 11

## art. 500F



4121



CE

Guanto in spugna di nitrile spalmato su nylon

**Applicazione:** edilizia, magazzinaggio, officina.

**Taglie:** S (7) - M (8) - L (9) - XL (10) - XXL (11)

**Packing:** 12 paia

**Imballo minimo per ordine:** 240 paia

**Scatola:** 240 paia - volume m<sup>3</sup> 0,10 - peso kg. 10

**Articolo dotato di codice a barre e busta appendibile**



[EN388 4121]



7 - 11

## art. 500NTS



4121



CE

Guanto in NYLON totalmente spalmato in nitrile.

**Taglia:** 7 - 8 - 9 - 10

**Applicazione:** industria, edilizia.

**Packing:** 12 paia

**Imballo minimo per ordine:** 120 paia

**Scatola:** 120 paia - volume m<sup>3</sup> 0,08 - peso kg. 8

**Articolo dotato di codice a barre e busta appendibile**



[EN388 4121]



7 - 10

### art. 500FR

[EN388 4121]



CE

4121



Guanto ad alta visibilità puntinato in spandex + nylon 15g spalmato sul palmo e nelle dita in spugna di nitrile. Resistente agli olii.

**Taglia:** 7- 8-9-10

**Applicazione :** industria, edilizia.

**Packing:** 12 paia

**Imballo minimo per ordine :** 120 paia

**Scatola:** 120 paia - volume m3 0,08 - peso kg. 8

**Articolo dotato di codice a barre e cartoncino appendibile.**



8



9



10



7



7 - 10

### art. 500FP

[EN388 4131]



CE

4131



Guanto ad alta visibilità puntinato in spandex + nylon 15g spalmato 3/4 in spugna di nitrile. Resistente agli olii.

**Taglia:** 7- 8-9-10

**Applicazione :** industria, edilizia.

**Packing:** 12 paia

**Imballo minimo per ordine :** 120 paia

**Scatola:** 120 paia - volume m3 0,08 - peso kg. 8

**Articolo dotato di codice a barre e cartoncino appendibile**



8



9



10



7



7 - 10

### art. 89

[EN374 EN388 4002]



CE

4002



Guanto in nitrile - cm 33

Spessore 0,38 mm

**Taglie:** 7 - 8 - 9 - 10

**Applicazione:** Chimica - Edilizia - Industria

**Packing:** 10 paia

**Imballo minimo per ordine:** 100 paia

**Scatola:** 100 paia - volume m³ 0,09 - peso Kg. 9

**Articolo dotato di codice a barre**



7



8



9



10



7 - 10



## art. 500P



4141



CE

Guanto di qualità superiore in poliuretano nero spalmato su nylon. Adatto per piccole lavorazioni in elettronica, minuteria, etc. Lavabile a 40°C con detergente neutro.

**Taglie:** 7 - 11

**Applicazione:** magazzino, industria leggera, meccanica di precisione

**Packing:** 12 paia

**Imballo minimo per ordine:** 240 paia

**Scatola:** 240 paia volume m<sup>3</sup> 0,09 - Kg. 9

**Articolo dotato di codice a barre e busta appendibile**



[EN388 4141]



7 - 11

## art. 500PCC



4131



CE

Guanto di qualità superiore in poliuretano nero spalmato su nylon. Adatto per piccole lavorazioni in elettronica, minuteria, etc. Lavabile a 40°C con detergente neutro. Con cartoncino espositore

**Taglie:** 8 - 10

**Applicazione:** Magazzinaggio, elettronica, meccanica di precisione

**Packing:** 12 paia

**Imballo minimo per ordine:** 120 paia

**Scatola:** 120 paia volume m<sup>3</sup> 0,10 Kg.8

**Articolo dotato di codice a barre e cartoncino espositore.**



[EN388 4131]



8 - 10

## art. 500P-ECO



3131



CE

Guanto in poliuretano nero spalmato su nylon. Adatto per piccole lavorazioni in elettronica, minuteria, etc. Lavabile a 40°C con detergente neutro.

**Taglie:** 6 - 11

**Applicazione:** Magazzinaggio, elettronica, meccanica di precisione

**Packing:** 12 paia

**Imballo minimo per ordine:**

240 paia

**Scatola:** 240 paia volume m<sup>3</sup> 0,10 Kg.10

**Articolo dotato di codice a barre e busta appendibile.**



[EN388 3131]



6 - 11

art. 500RF

[EN388 3131]

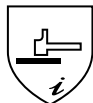

3131



Guanto POLYSTRONG in poliuretano con dita rinforzate spalmato su nylon. Adatto per medie lavorazioni in elettronica, minuteria, etc. Lavabile a 40°C con detergente neutro.

**Taglie:** 7 - 8 - 9 - 10

**Applicazione:** Edilizia leggera, magazzino, elettronica, meccanica di precisione

**Packing:** 12 paia

**Imballo minimo per ordine:** 240 paia

**Scatola:** 240 paia volume m<sup>3</sup> 0,10 Kg.10

**Articolo dotato di codice a barre e confezione appendibile in busta.**



Possibilità di acquisto con espositore completo da 48 paia (Art. 5 Kit)



7 - 10

art. 500AZ

[EN388 3131]

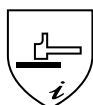

3131



Guanto in nylon spalmato sul palmo e nelle dita in poliuretano, rinforzato nelle estremità.

**Taglia:** 7- 8-9-10

**Applicazione:** elettronica, industria di precisione.

**Packing:** 12 paia

**Imballo minimo per ordine:** 120 paia

**Scatola:** 120 paia - volume m<sup>3</sup> 0,08 - peso kg. 8

**Articolo dotato di codice a barre e busta appendibile**



7 - 10

art. 500PG

[EN388 3131]

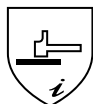

3131



Guanto in poliuretano grigio spalmato su nylon. Adatto per piccole lavorazioni in elettronica, minuteria, etc. Lavabile a 40 ° con detergente neutro.

**Taglie:** 6-7-8-9-10-11

**Applicazione:** magazzino, elettronica, meccanica di precisione.

**Packing:** 12 paia

**Imballo minimo per ordine:** 240 paia

**Scatola:** 240 paia volume m<sup>3</sup> 0,10 KG. 10

**Articolo dotato di codice a barre e busta appendibile.**



6 - 11

## art. 500PM - art. 500PMB

[EN388 2131]



2131



CE

Guanto mimetico in polycotton spalmato sul palmo e nelle dita in lattice.

**Taglia:** 7- 10

**Applicazione:** edilizia, giardinaggio, forestale.

**Packing:** 12 paia

**Imballo minimo per ordine:** 120 paia

**Scatola:** 120 paia - volume m<sup>3</sup> 0,08 - peso kg. 8

**Articolo dotato di codice a barre e busta appendibile.**



art.500PMB



8 011818 171495

7



8 011818 170856

8



8 011818 170863

9



8 011818 170870

10



8 011818 170887



7 - 10



art.  
500PMB  
BABY

## art. 500FC - art. 500FCB

[EN388 2131]



2131



CE

Guanto fantasia in nylon spalmato sul palmo e nelle dita in nitrile.

**Taglia:** 7-10

**Applicazione:** giardinaggio, garden.

**Packing:** 12 paia

**Imballo minimo per ordine:** 120 paia

**Scatola:** 120 paia - volume m<sup>3</sup> 0,08 - peso kg. 8

**Articolo dotato di codice a barre e busta appendibile.**



art.500FCB



8 011818 171488

7



8 011818 170931

8



8 011818 170948

9



8 011818 170955

10



8 011818 170962



7 - 10



art.  
500FCB  
BABY

## art. 600BO

[EN388 013X]



013X



CE

Guanto nylon spalm. poliuretano solo nelle dita

**Taglie:** 7 - 10

**Applicazione:** meccanica di precisione - elettronica

**Packing:** 12 paia

**Imballo minimo per ordine:** 240 paia

**Scatola:** 240 paia - volume m<sup>3</sup> 0,09 - Kg.9

**Articolo dotato di codice a barre.**



S (7)



8 011818 102994

M (8)



8 011818 103007

L (9)



8 011818 103014

XL (10)



8 011818 103021



7 - 10

art. 500BO

[EN388 4131]

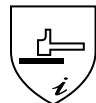

4131



Guanto di qualità superiore in poliuretano spalmato su nylon. Adatto per piccole lavorazioni in elettronica, minuteria, etc. Lavabile a 40°C con detergente neutro.

**Taglie:** 7 - 11

**Applicazione:** Magazzinaggio, elettronica, meccanica di precisione

**Packing:** 24 paia

**Imballo minimo per ordine:** 24 paia

**Scatola:** 72 paia - volume m<sup>3</sup> 0,10 - Kg.10

**Articolo dotato di codice a barre e cartoncino espositore**



7 - 11

art. 500BO-SC

[EN388 4141]

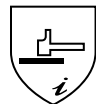

4141



Guanto di qualità superiore in poliuretano spalmato su nylon. Adatto per piccole lavorazioni in elettronica, minuteria, etc. Lavabile a 40°C con detergente neutro.

**Taglie:** 6 - 11

**Applicazione:** Magazzinaggio, elettronica, meccanica di precisione

**Packing:** 12 paia

**Imballo minimo per ordine:** 240 paia

**Scatola:** 240 paia volume m<sup>3</sup> 0,10 Kg.10

**Articolo dotato di codice a barre e busta appendibile.**



6 - 11

art. 500BO-ECO

[EN388 3131]

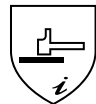

3131



Guanto in poliuretano bianco spalmato su nylon. Adatto per piccole lavorazioni in elettronica, minuteria, etc. Lavabile a 40°C con detergente neutro.

**Taglie:** 6 - 11

**Applicazione:** Magazzinaggio, elettronica, meccanica di precisione

**Packing:** 12 paia

**Imballo minimo per ordine:** 240 paia

**Scatola:** 240 paia volume m<sup>3</sup> 0,10 Kg.10

**Articolo dotato di codice a barre e busta appendibile.**



6 - 11

## art. 500TS



2131



CE

Guanto in nylon con doppia spalmatura in lattice, finitura rugosa nel palmo.

**Taglia:** 7-8-9-10

**Applicazione:** industria, edilizia.

**Packing:** 12 paia

**Imballo minimo per ordine:** 120 paia

**Scatola:** 120 paia - volume m3 0,10 - peso kg. 9

**Articolo dotato di codice a barre e cartoncino espositore.**



[EN388 2131]



7 - 10

## art. 500AR



2131



CE

Guanto in poliestere spalmato in lattice rugoso.

**Imballo minimo per ordine PA120**

**Scatola:** 0,10 m<sup>3</sup> - Peso kg. 9

**Articolo dotato di codice a barre e cartoncino espositore.**



[EN388 2131]



7 - 10

## art. 500LX



3121



CE

Guanto in lattice zigrinato spalmato su nylon

**Applicazione:** edilizia, magazzino, officina.

**Taglie:** S(7) - M (8) - L (9) - XL (10) - XXL (11)

**Packing:** 12 paia

**Imballo minimo per ordine:** 240 paia

**Scatola:** 240 paia - volume m<sup>3</sup> 0,10 - peso kg. 10

**Articolo dotato di codice a barre e busta appendibile**



[EN388 3121]



7 - 11

art. 0310BL

[EN388 2142]

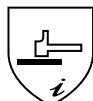

2142



CE

Guanto in gomma con supporto in filo continuo.

**Taglie:** 8 - 11

**Applicazione:** edilizia - magazzinaggio

**Packing:** 24 paia

**Imballo minimo per ordine:** 24 paia

**Scatola:** 72 paia - volume m<sup>3</sup> 0,10 - peso Kg. 10

**Articolo dotato di codice a barre e cartoncino espositore.**



8 - 11

art. 0600

[EN388 2142]

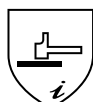

2142

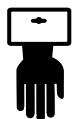

CE

Guanto in gomma con supporto in filo continuo.

**Taglie:** 8 - 9 - 10

**Applicazione:** edilizia - magazzinaggio - giardinaggio

**Packing:** 24 paia

**Imballo minimo per ordine:** 24 paia

**Scatola:** 72 paia - volume m<sup>3</sup> 0,10 - peso Kg. 10

**Articolo dotato di codice a barre e cartoncino espositore**



8 - 10

art. 08SC

[EN388 4232]



4232



CE

Guanto a filo continuo in cotone, spalmatura in gomma nel palmo e nelle dita. Particolarmente indicato in edilizia, nella lavorazione del marmo, in carpenteria, nelle lavorazioni del vetro, contro l'abrasione ed il taglio

**Taglia:** 10

**Applicazione:** edilizia - vetrerie

**Packing:** 12 paia

**Imballo minimo per ordine:** 120 paia

**Scatola:** 120 paia - volume m<sup>3</sup> 0,10 - peso Kg. 10

**Articolo dotato di codice a barre**



UNICA

## art. 04

[EN374 EN388 3100]



CE



Guanto in PVC floccato antiacido, antiallergico. cm 30

**Taglie:** 8 - 11

**Applicazione:** industria chimica - edilizia - pulizie

**Packing:** 25 paia

**Imballo minimo per ordine:** 25 paia

**Scatola:** 200 paia - volume m<sup>3</sup> 0,15 - peso kg. 15

**Articolo dotato di codice a barre e busta appendibile.**



8 - 11

## art. 6

[EN 374-EN388 4120]



CE



Guanto in gomma uso industriale cm 32 - Spessore 0,90 mm

**Taglie:** 7 - 8 - 9 - 10

**Applicazione:** industria pulizia industriale - alimentare

**Packing:** 10 paia

**Imballo minimo per ordine:** 50 paia

**Scatola:** 50 paia - volume m<sup>3</sup> 0,10 peso Kg. 10

**Articolo dotato di codice a barre e busta appendibile.**



7 - 10

## art. 65M

[EN374 EN388 3000]



CE



Guanto in lattice naturale - satinato - cm 30

**Taglie:** 7 - 8 - 9 - 10

**Applicazione:** casalingo - pulizie - alimentare

**Packing:** 12 paia

**Imballo minimo per ordine:** 144 paia

**Scatola:** 144 paia - volume m<sup>3</sup> 0,10 - peso Kg. 9

**Articolo dotato di codice a barre e busta appendibile.**



7 - 10

art. 65

[EN420 - CAT. 1]



CE



Guanto casalingo in lattice floccato - cm 27  
**Applicazione:** casalingo - pulizie - alimentare  
**Taglie:** 7 - 10  
**Packing:** 12 paia  
**Imballo minimo per ordine:** 144 paia  
**Scatola:** 144 paia - volume m<sup>3</sup> 0,10 - peso kg. 9  
**Articolo dotato di codice a barre**

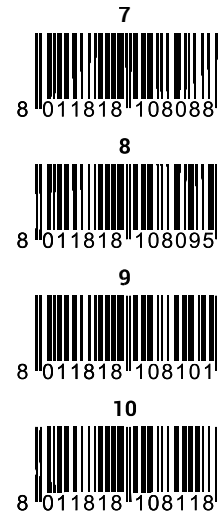

art. 60

[EN374 - EN388 2011]



2011

CE



Guanto in neoprene antiacido - cm 32  
 Spessore 0,68 mm  
**Taglie:** 7 - 8 - 9 - 10  
**Applicazione:** industria - chimica - edilizia  
**Packing:** 10 paia  
**Imballo minimo per ordine:** 100 paia  
**Scatola:** 100 paia - volume m<sup>3</sup> 0,09 - peso Kg. 9  
**Articolo dotato di codice a barre e busta appendibile**



art. 60A

[EN374 EN388 1011]



1011

CE



Guanto in neoprene bicolore - cm 32  
 Spessore 0,50 mm  
**Taglie:** 7 - 10  
**Applicazione:** industria - chimica - edilizia  
**Packing:** 10 paia  
**Imballo minimo per ordine:** 100 paia  
**Scatola:** 100 paia - volume m<sup>3</sup> 0,09 - peso Kg. 9  
**Articolo dotato di codice a barre e busta appendibile**





## art. 500PNT



4544



CE

Guanto ad alta visibilità in tessuto 13G / fibra di vetro antitaglio LIVELLO 5, spalmatura rugosa nel palmo in nitrile e protezione del dorso antiurto in TPR. Cinturino con velcro al polso.

**Taglia:** 8-9-10

**Applicazione:** lavorazioni del vetro o in presenza di sbavature metalliche, meccanica, edilizia.

**Packing:** 12 paia

**Imballo minimo per ordine:** 60 paia

**Scatola:** 60 paia - volume m<sup>3</sup> 0,10 - peso kg. 9

**Articolo dotato di codice a barre e cartoncino espositore.**



[EN388 4544]



8



8 011818 171006

9



8 011818 171013

10



8 011818 171020



8 - 10

## art. 500ATB



4543



CE

Guanto in fibra di vetro e UHMWPE in con spalmatura in poliuretano. Livello di resistenza al taglio 5. Lavabile in lavatrice a 40° con detergenti naturali.

**Applicazione:** manipolazione del vetro, riciclo, lavori con lastre di metallo, taglio, lavori di imbottigliamento e impagliamenti/rivestimento - lavori di precisione.

**Taglia:** 7-8-9-10 **Packing:** 12 paia

**Imballo minimo per ordine:** 120 paia

**Scatola:** 120 paia - volume m<sup>3</sup> 0,08 - peso kg. 9

**Articolo dotato di codice a barre e cartoncino espositore**



[EN388 4543]



8



8 011818 163926

9



8 011818 163933

7



8 011818 163919

10



8 011818 163940



7 - 10

## art. 500DNMG



4343



CE

Guanto grigio in spalmato in poliuretano che offre alti livelli di resistenza al taglio, ideale per precise e delicate operazioni di resistenza al taglio. Questi guanti possono essere lavati a 40°C con detergenti naturali.

**Applicazione:** manipolazione del vetro - riciclo - lavori con lastre di metallo - taglio - lavori di imbottigliamento e impagliamenti/rivestimento - lavori di precisione

**Taglie:** 7 - 11 - **Packing:** 12 paia

**Imballo minimo per ordine:** 120 paia

**Scatola:** 120 paia - volume m<sup>3</sup> 0,10 - peso kg. 8

**Articolo dotato di codice a barre**



[EN388 4343]



8



8 011818 120080

9



8 011818 120097

10



8 011818 120103

7



8 011818 153538

11



8 011818 120110



7 - 11

art. 500ATS

[EN388 4543]

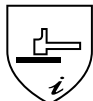

CE

4543



Guanto in nylon e tessuto 13G / fibra di vetro antitaglio LIVELLO 5, doppia spalmatura in nitrile, finitura rugosa nel palmo.

**Taglia:** 8-9-10

**Applicazione:** lavorazioni del vetro o in presenza di sbavature metalliche, industria, edilizia.

**Packing:** 12 paia

**Imballo minimo per ordine:** 120 paia

**Scatola:** 120 paia - volume m3 0,10 - peso kg. 10

**Articolo dotato di codice a barre e cartoncino appendibile.**



8 - 10

art. 500ATL

[EN388 4543]

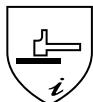

CE

4543



Guanto in tessuto 13G / fibra di vetro antitaglio LIVELLO 5, spalmatura rugosa nel palmo in nitrile e protezione del dorso antiurto.

**Taglia:** 8-9-10

**Applicazione:** lavorazioni del vetro o in presenza di sbavature metalliche, meccanica, edilizia.

**Packing:** 12 paia

**Imballo minimo per ordine:** 120 paia

**Scatola:** 120 paia - volume m3 0,10 - peso kg. 10

**Articolo dotato di codice a barre e cartoncino appendibile.**



8 - 10

## art. 500LT

[EN388 4544]



4544



CE

Guanto lungo antitaglio in nylon 13G / fibra di vetro antitaglio LIVELLO 5, spalmatura rugosa in nitrile.

**Taglia:** 8-9-10

**Applicazione:** lavorazioni del vetro o in presenza di sbavature metalliche, meccanica, edilizia.

**Packing:** 12 paia

**Imballo minimo per ordine:** 60 paia

**Scatola:** 60 paia - volume m3 0,10 - peso kg. 9

**Articolo dotato di codice a barre**



8

8 011818 170979



9

8 011818 170986



10

8 011818 170993



8 - 10

## art. 77ATL

[EN388 4543]



4543



CE

Guanto in nylon e tessuto 7G / fibra di vetro antitaglio LIVELLO 5, doppia spalmatura in nitrile, finitura rugosa nel palmo. Lunghezza cm 48.

**Taglia:** 9-10

**Applicazione:** lavorazioni del vetro o in presenza di sbavature metalliche, industria, edilizia.

**Packing:** 12 paia

**Imballo minimo per ordine:** 60 paia

**Scatola:** 60 paia - volume m3 0,10 - peso kg. 10

**Articolo dotato di codice a barre**



9

8 011818 171297



10

8 011818 171303



9 - 10

## art. 57ATP

[EN388 454X]



454X



CE

Guanto in nylon e tessuto 7G / fibra di vetro antitaglio LIVELLO 5, puntinato in NBR.

**Taglia:** 9-10

**Applicazione:** lavorazioni del vetro o in presenza di sbavature metalliche, industria, edilizia.

**Packing:** 12 paia

**Imballo minimo per ordine:** 120 paia

**Scatola:** 120 paia - volume m3 0,08 - peso kg. 8

**Articolo dotato di codice a barre e busta appendibile.**



9

8 011818 134698



10

5 010699 814340



9 - 10

art. 600ATB



CE

454X



Guanto in tessuto 13G / fibra di vetro antitaglio LIVELLO 5

**Taglia:** 8-9-10

**Applicazione:** lavorazioni del vetro o in presenza di sbavature metalliche, industria, edilizia.

**Packing:** 12 paia

**Imballo minimo per ordine:** 120 paia

**Scatola:** 120 paia - volume m3 0,08 - peso kg. 8

**Articolo dotato di codice a barre e busta appendibile.**



[EN388 454X]



8 - 10

art. 57AT



CE

454X



Guanto in nylon e tessuto 7G / fibra di vetro antitaglio LIVELLO 5

**Taglia:** 8-9-10

**Applicazione:** lavorazioni del vetro o in presenza di sbavature metalliche, industria, edilizia.

**Packing:** 12 paia

**Imballo minimo per ordine:** 120 paia

**Scatola:** 120 paia - volume m3 0,08 - peso kg. 8

**Articolo dotato di codice a barre e busta appendibile.**



[EN388 454X]



8 - 10

art. 290



CE

2241



Guanto in nylon 7G.

**Taglia:** 8-9-10

**Applicazione:** utilizzabile come sottoguanto, nei magazzini o nei lavori di precisione. Adatto settore alimentare

**Packing:** 12 paia

**Imballo minimo per ordine:** 120 paia

**Scatola:** 120 paia - volume m3 0,08 - peso kg. 7

**Articolo dotato di codice a barre e busta appendibile.**



[EN388 2241]



8 - 10

### art. 58ATM



454X



CE

Manicotto avambraccio in tessuto 13G / fibra di vetro antitaglio LIVELLO 5 ,lunghezza cm. 30

**Taglia:** 8-9-10

**Applicazione :** lavorazioni del vetro o in presenza di sbavature metalliche, meccanica, edilizia.

**Packing:** 12 paia

**Imballo minimo per ordine :** 60 paia

**Scatola:** 60 paia - volume m<sup>3</sup> 0,07 - peso kg. 6

**Articolo dotato di codice a barre e busta appendibile.**



[EN388 454X]



8 - 10



Guanto in maglia di acciaio, con protezione avambraccio in materiale plastico resistente al taglio, **Applicazione:** industria alimentare.

**Taglia:** XS - S - M - L

**Packing:** 1 pezzo

**Imballo minimo per ordine:** 1 pezzo

**Scatola:** 1 pezzo - volume m<sup>3</sup> 0,04 - peso kg. 0,3

**Articolo dotato di codice a barre**

[EN1082]



CE

### art. 300AVE

[EN1082]



CE BORDINO VERDE



### art. 300ABI

[EN1082]



CE BORDINO BIANCO



### art. 300A

[EN1082]



CE BORDINO ROSSO



### art. 300ABL

[EN1082]



CE BORDINO BLUE





[EN1082]



Guanto in maglia d'acciaio per macellai

**Taglie:** XS - S - M - L

**Applicazione:** industria alimentare.

**Packing:** 1 pezzo

**Imballo minimo per ordine:** 1 pezzo

**Scatola:** 1 pezzo - volume m<sup>3</sup> 0,03 - peso kg. 0,2

**Articolo dotato di codice a barre**



## art. 300VE

[EN1082]

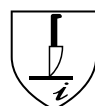

CE BORDINO VERDE



## art. 300BI

[EN1082]

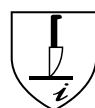

CE BORDINO BIANCO



## art. 300

[EN1082]

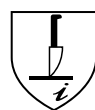

CE BORDINO ROSSO



## art. 300BL

[EN1082]

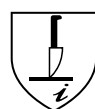

CE BORDINO BLUE



art. 91



4111



CE



[EN388 4111]



Guanto NBR con polsino in maglia e dorso areato

**Taglie:** 7 - 10

**Applicazione:** Industria - Edilizia - agricoltura

**Packing:** 48 paia

**Imballo minimo per ordine:** 48 paia

**Scatola:** 96 paia - volume m<sup>3</sup> 0,10 - Kg. 10

**Articolo dotato di codice a barre e cartoncino espositore**



7 - 10

art. 91ECO-SC



4111



CE

[EN388 4111]

Guanto NBR con polsino in maglia e dorso areato

**Taglie:** 7 - 10

**Applicazione:** Industria - Edilizia - agricoltura

**Packing:** 12 paia

**Imballo minimo per ordine:** 144 paia

**Scatola:** 144 paia - volume m<sup>3</sup> 0,10 - Kg. 10

**Articolo dotato di codice a barre e busta appendibile**



7 - 10

art. 76AE SC

[EN388 4211]



CE

4211



Guanto NBR, dorso areato, maniccotto in tela, tipo economico

**Taglie:** 10

**Applicazione:** industria, edilizia

**Packing:** 12 paia

**Imballo minimo per ordine:** 120 paia

**Scatola:** 120 paia - volume m<sup>3</sup> 0,09 - peso Kg. 11

**Articolo dotato di codice a barre e busta appendibile.**



UNICA

art. 76APE SC

[EN388 4211]

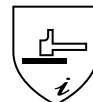

CE

4211



Guanto NBR, dorso areato con polso a maglia, tipo economico

**Taglie:** 9 - 10

**Applicazione:** industria - edilizia

**Packing:** 12 paia

**Imballo minimo per ordine:** 120 paia

**Scatola:** 120 paia - volume m<sup>3</sup> 0,09 - peso Kg. 11

**Articolo dotato di codice a barre e busta appendibile.**



9 - 10

art. 77AE SC

[EN388 4211]

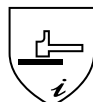

CE

4211



Guanto NBR tutto spalmato con maniccotto in tela economico

**Taglie:** 9 - 10

**Applicazione:** industria - edilizia

**Packing:** 12 paia

**Imballo minimo per ordine:** 120 paia

**Scatola:** 120 paia - volume m<sup>3</sup> 0,09 - peso Kg. 11

**Articolo dotato di codice a barre e busta appendibile.**



9 - 10



## art. 77APE SC

[EN388 4211]



4211



CE

Guanto NBR tutto spalmato con polso a maglia. Tipo economico

**Taglie:** 9 - 10

**Applicazione:** Industria, edilizia

**Packing:** 12 paia

**Imballo minimo per ordine:** 120 paia

**Scatola:** 120 paia, volume m<sup>3</sup> 0,09 - peso Kg. 11

**Articolo dotato di codice a barre e busta appendibile**



## art. 76A

[EN388 4221]



4221



CE

Guanto in NBR, dorso areato, maniccotto in tela

**Taglia:** 10

**Applicazione:** industria, edilizia

**Packing:** 12 paia

**Imballo minimo per ordine:** 120 paia

**Scatola:** 120 paia - volume m<sup>3</sup> 0,10 - peso Kg. 12

**Articolo dotato di codice a barre**



## art. 76AP

[EN388 4221]



4221



CE

Guanto NBR dorso areato, con polso a maglia

**Taglie:** 9 - 10

**Applicazione:** industria - edilizia

**Packing:** 12 paia

**Imballo minimo per ordine:** 120 paia

**Scatola:** 120 paia - volume m<sup>3</sup> 0,09 - peso Kg. 11

**Articolo dotato di codice a barre.**



art. 77A

[EN388 4221]



CE

4221



Guanto NBR tutto spalmato con maniccotto in tela  
**Taglie:** 10  
**Applicazione:** industria - edilizia  
**Packing:** 12 paia  
**Imballo minimo per ordine:** 120 paia  
**Scatola:** 120 paia - volume m<sup>3</sup> 0,09 - peso Kg. 11  
**Articolo dotato di codice a barre.**



UNICA

art. 77AP

[EN388 4221]



CE

4221



Guanto NBR tutto spalmato con polso a maglia  
**Taglie:** 9 - 10  
**Applicazione:** Industria, edilizia  
**Packing:** 12 paia  
**Imballo minimo per ordine:** 120 paia  
**Scatola:** 120 paia, volume m<sup>3</sup> 0,09 - peso Kg. 11  
**Articolo dotato di codice a barre.**



9 - 10

art. 77AL 30

[EN388 4121]



CE

4121



Guanto spalmato NBR cm.30 supporto in cotone  
**Taglia:** 10  
**Applicazione:** Industria, edilizia  
**Packing:** 5 paia  
**Imballo minimo per ordine:** 120 paia  
**Scatola:** 120 paia, volume m<sup>3</sup> 0,12 - peso Kg. 11  
**Articolo dotato di codice a barre.**



UNICA

## art. 77AL 80

[EN388 4111]



4111



Guanto spalmato NBR con manichetta sintetica in tessuto spalmato. Lunghezza totale cm 80.

**Taglie:** 10

**Applicazione:** Questo articolo è molto indicato nelle seguenti lavorazioni: sabbiatura, verniciatura, lavorazioni con problemi di acido, olio, abrasione e taglio.

**Packing:** 1 paio

**Imballo minimo per ordine:** 12 paia

**Scatola:** 72 paia - volume m<sup>3</sup> 0,10 - Kg. 8

**Articolo dotato di codice a barre e busta appendibile**



10



8 011818 126952



UNICA

## art. 0360

[EN374-EN388 4110]



4110



Guanto in nitrile lungo cm 60 spess. mm 0,2 manicotto leggero in EVA

**Taglie:** 8 - 9 - 10

**Applicazione:** industria, edilizia, ispezione

**Packing:** 1 paio

**Imballo minimo per ordine:** 1 paio

**Scatola:** 12 paia - volume m<sup>3</sup> 0,04 - Kg.4

**Articolo dotato di codice a barre e busta appendibile**



8



8 011818 133998

10



8 011818 134001

9



8 011818 124965



8 - 10

art. 4FTOP

[EN388 - 2132]



CE

2132



Guanto fiore bovino foderato internamente in flanella

**Taglia:** 10

**Applicazione:** edilizia, industria, agricoltura, magazzini.

**Packing:** 10 paia

**Imballo minimo per ordine:** 60 paia

**Scatola:** 60 paia - volume m<sup>3</sup> 0,10 - peso kg. 12

**Articolo dotato di codice a barre.**



UNICA



art. 4FM

[EN388 - 2132]



CE

2132



Guanto fiore bovino e maglia foderato in flanella

**Taglia:** 10

**Applicazione:** edilizia, industria, agricoltura, magazzini.

**Packing:** 10 paia

**Imballo minimo per ordine:** 60 paia

**Scatola:** 60 paia - volume m<sup>3</sup> 0,10 - peso kg. 10

**Articolo dotato di codice a barre.**



UNICA



art. 500FB

[EN388 - EN3131]

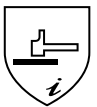

CE

3131



Guanto in nylon con doppia spalmatura in lattice, finitura rugosa nel palmo.

**Taglia:** 7- 8-9-10

**Applicazione:** industria, edilizia.

**Packing:** 12 paia

**Imballo minimo per ordine:** 120 paia

**Scatola:** 120 paia - volume m<sup>3</sup> 0,10 - peso kg. 9

**Articolo dotato di codice a barre e cartoncino espositore.**



7

9



8

10



7 - 10

## art. 500FN

[EN388 2232 - EN511 X1X]

CE

Guanto in lattice zigrinato traspirante, spalmato su nylon. Fodera interna in acrilico.

**Taglia:** 9-10

**Applicazione:** edilizia, industria.

**Packing:** 12 paia

**Imballo minimo per ordine:** 120 paia

**Scatola:** 120 paia - volume m<sup>3</sup> 0,10 - peso kg. 10

**Articolo dotato di codice a barre.**



9 - 10



2232



X1X



12

## art. 500FG

[EN420 - EN388 2322 EN511X1X]

CE

Guanto ad alta visibilita' in spugna di nitrile traspirante zigrinata, spalmato su nylon. Fodera interna in acrilico.

**Taglia:** 8-9-10

**Applicazione:** lavori stradali, edilizia, industria.

**Packing:** 12 paia

**Imballo minimo per ordine:** 120 paia

**Scatola:** 120 paia - volume m<sup>3</sup> 0,10 - peso kg. 10

**Articolo dotato di codice a barre.**



8 - 10



2322



X1X



12

## art. 95

[EN388 3221]

CE

Guanto PVC con fodera amovibile - cm32

**Taglia:** 10

**Applicazione:** Particolarmente indicato per: segnalazioni aeroportuali (essendo fluorescente), operazioni stradali, lavorazione del pesce e delle carni surgelate e nelle celle frigorifere (in quanto resistono alle basse temperature)

**Packing:** 6 paia

**Imballo minimo per ordine:** 6 paia

**Scatola:** 60 paia - volume m<sup>3</sup> 0,10 - peso kg. 10

**Articolo dotato di codice a barre.**



UNICA



3221



6

art. 97



Guanto invernale in pile (100% poliestere), interno in thinsulate®. **NON E' UN DPI**  
**Applicazione:** lavorazioni a basse temperature, tempo libero.

**Taglie:** 10

**Packing:** 12 paia

**Imballo minimo per ordine:** 120 paia

**Scatola:** 120 paia - volume m<sup>3</sup> 0,10 - peso kg. 7

**Articolo dotato di codice a barre.**



UNICA

GUANTI IN PVC

art. 04L

[EN374 - EN388 2100]



CE

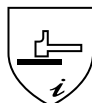

2100



Guanto in PVC floccato antiacido, antiolio, antiallergico. cm 30 - Felpatura interna, manichetta in trama di nylon bispalmata in PVC. Lunghezza totale cm 80

**Taglie:** M - L - XL - XXL

**Applicazione:** industria - edilizia

**Packing:** 1 paio

**Imballo minimo per ordine:** 1 paio

**Scatola:** 100 paia - volume m<sup>3</sup> 0,15 peso kg. 15

**Articolo dotato di codice a barre e busta appendibile**



M - XXL

## art. 07

[EN388 4121]



4121



12

CE

Guanto PVC cm 27 – con supporto in cotone

**Taglia:** 10

**Applicazione:** industria - edilizia

**Packing:** 12 paia

**Imballo minimo per ordine:** 120 paia

**Scatola:** 120 paia - volume m<sup>3</sup> 0,12 - peso kg. 12

**Articolo dotato di codice a barre.**



UNICA

## art. 06 SC

[EN388 4121]



4121



12

CE

Guanto PVC cm 35 – con supporto in cotone

**Taglia:** 10

**Applicazione:** industria - edilizia

**Packing:** 12 paia

**Imballo minimo per ordine:** 120 paia

**Scatola:** 120 paia - volume m<sup>3</sup> 0,12 - peso kg. 12

**Articolo dotato di codice a barre.**



UNICA

## art. 05

[EN388 3121]



3121



12

CE

Guanto PVC cm 45 – con supporto in cotone

**Taglia:** 10

**Applicazione:** industria - edilizia

**Packing:** 12 paia

**Imballo minimo per ordine:** 72 paia

**Scatola:** 72 paia - volume m<sup>3</sup> 0,12 - peso kg. 12

**Articolo dotato di codice a barre.**



UNICA

art. 62NT

[EN388 - EN374-2 EN374-3]

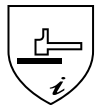

Guanto monouso in nitrile molto resistente (box da 100 pz) - Senza polvere interna

**Taglie:** S - M - L - XL

**Applicazione:** Ispezione, industria, pulizia, laboratori

**Packing:** 1 box (100pz)

**Imballo minimo per ordine:** 10 Box

**Scatola:** 10 box - volume m<sup>3</sup> 0,10 - peso kg. 10

**Articolo dotato di codice a barre**

**NO POWDER  
NITRILE**



S-XL

art. 62NDS

[EN455-1/2/3 + A1 2011]



Guanto in nitrile senza polvere interna, per uso alimentare.

Doppio spessore (mm 0,15).

Lunghezza cm 26.

**Taglie:** M - L - XL - XXL

**Applicazione:** Ispezione, industria, pulizia, laboratori, alimentare

**Packing:** 1 box (50pz)

**Imballo minimo per ordine:**

10 box da 50 pz. cadauno

**Scatola:** 10 box - volume m<sup>3</sup> 0,07 - peso kg. 6

**Articolo dotato di codice a barre e confezione appendibile**

**NO POWDER**



**STRONG  
NITRILE**



M - XXL

art. 64P

[EN 420 - EN 374]



0 0 8 8

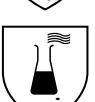
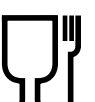

Guanto in lattice con polvere interna per uso alimentare. 100 pezzi

**Applicazione:** uso alimentare, ispezione, pulizie

**Taglie:** 6,5 - 7,5 - 8,5 - 9,5

**Packing:** 1 box (100pz.)

**Imballo minimo per ordine:** 10 box

**Scatola:** 10 box

**Articolo dotato di codice a barre.**

**POWDER  
LATEX**



6,5 - 9,5



## art. 64DS

[CE EN374 1/2/3  
EN388]

## art. 62



CE



Guanto in lattice blu doppio spessore, senza polvere, lunghezza cm 30 ( box 50 pz )

**Applicazione :** industria, meccanica, alimentare.

**Taglie :** M-L-XL

**Packing :** 50 pz

**Imballo minimo per ordine:** 10 box

**Articolo dotato di codice a barre**

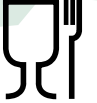

BOX  
50



**NO POWDER  
STRONG LATEX**



M - XL



BOX  
100



UNICA

## art. 64A

[EN388 EN374-2 EN374-3]



Guanti in lattice (box 100 pezzi) con polvere interna

**Applicazione:** ispezione

**Taglie:** S - M - L - XL

**Packing:** 1 box (100 pz.)

**Imballo minimo per ordine:** 10 box

**Scatola:** 10 box - volume m<sup>3</sup> 0,08 - peso Kg. 7

**Articolo dotato di codice a barre.**



BOX  
100

CE



**POWDER  
LATEX**



S - XL

## art. 62A

[EN455 1/2/3 - EN374 1/2/3 - EN 388]



Guanto in vinile con polvere interna (box dispenser da 100 pz)

**Applicazione:** ispezione, pulizie

**Taglie:** S - M - L - XL

**Packing:** 1 box (100 pz.)

**Imballo minimo per ordine:** 10 box

**Scatola:** 10 box - volume m<sup>3</sup> 0,09 - peso Kg.9

**Articolo dotato di codice a barre .**



BOX  
100



**POWDER  
PVC**



CE

S - XXL

art. 57GM

[EN388 214X]

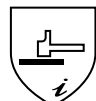

CE

214X



Guanto in poliestere 13G puntinato nel palmo.  
**Taglia:** 7- 8-9-10  
**Applicazione:** giardinaggio, edilizia,  
**Packing:** 12 paia  
**Imballo minimo per ordine:** 120 paia  
**Scatola:** 120 paia - volume m3 0,08 - peso kg. 8  
**Articolo dotato di codice a barre e busta appendibile.**



8



9



10

7



7 - 10

art. 57FLUO

[EN388 112X]



CE

112X



Guanto fluorescente in tessuto acrilico 7G con riporti in pvc.  
**Taglia:** 7- 8-9-10  
**Applicazione:** giardinaggio, edilizia, magazzini.  
**Packing:** 12 paia  
**Imballo minimo per ordine:** 120 paia  
**Scatola:** 120 paia - volume m3 0,08 - peso kg. 8  
**Articolo dotato di codice a barre e busta appendibile.**



8



9



10

7



7 - 10

art. 57G

[EN388 424X]

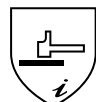

CE

424X



Guanto in cotone/poliestere spalmato in PVC  
**Taglie:** 9 - 10  
**Tessuto:** cotone / poliestere / pvc  
**Applicazione:** elettronica , meccanica, magazzini  
**Packing:** 12 paia  
**Imballo minimo per ordine:** 120 paia  
**Scatola:** 120 paia - volume m³ 0,08 - Kg.7  
**Articolo dotato di codice a barre.**



9



10



9 - 10

## art. 57SC

art. 57



Guanto in cotone/poliestere spalmato in PVC

**Taglie:** 9 - 10 - **Tessuto:** Cotone, PVC

**Applicazione:** Giardinaggio, magazzino

**Packing:** 12 paia

**Imballo minimo per ordine:** 300 paia

**Scatola:** 300 paia - volume m<sup>3</sup> 0,10 - peso Kg.10

**Articolo dotato di codice a barre senza cartoncino espositore**



art. 57SC



12



## art. 57

[EN420 - CAT.1]

Con cartoncino espositore.



9 - 10

## art. 57AR



12



Guanto in cotone polka spalmato in PVC.

**Applicazione:** giardinaggio, magazzino

**Taglie:** 9 - 10

**Packing:** 12 paia

**Imballo minimo per ordine:** 300 paia

**Scatola:** 300 paia - volume m<sup>3</sup> 0,15 - peso kg. 10

**Articolo dotato di codice a barre.**



[EN420 - CAT.1]



9 - 10

## art. 57C

[EN420 CAT. 1]



8

Guanto in cotone/poliestere spalmato in PVC

**Taglie:** 8

**Tessuto:** Cotone, poliestere, PVC

**Applicazione:** Giardinaggio, magazzino

**Packing:** 48 paia

**Imballo minimo per ordine:** 48 paia

**Scatola:** 96 paia - volume m<sup>3</sup> 0,08 - peso Kg.8

**Articolo dotato di codice a barre e cartoncino espositore.**



## art. 57C - 7

[EN420 CAT. 1]



7

Guanto in cotone/poliestere spalmato in PVC

**Taglie:** 7

**Tessuto:** Cotone, poliestere, PVC

**Applicazione:** Giardinaggio, magazzino

**Packing:** 48 paia

**Imballo minimo per ordine:** 48 paia

**Scatola:** 96 paia - volume m<sup>3</sup> 0,08 - peso Kg.8

**Articolo dotato di codice a barre e cartoncino espositore.**

art. 57A

[EN420 - CAT. 1]



CE



Guanto in cotone/poliestere spalmato in PVC

**Taglie:** 9 - 10

**Tessuto:** Cotone, poliestere, PVC

**Applicazione:** Giardinaggio, magazzinaggio

**Packing:** 48 paia

**Imballo minimo per ordine:** 48 paia

**Scatola:** 96 paia - volume m<sup>3</sup> 0,08 - peso Kg.8

**Articolo dotato di codice a barre e cartoncino espositore**



9 - 10

art. 57V

[EN420 - CAT. 1]



CE



Guanto da giardino palmo in tessuto resinato, dorso e manicotto in tela di cotone.

**Applicazione:** giardinaggio, magazzinaggio.

**Taglie:** 9 - 10

**Packing:** 12 paia

**Imballo minimo per ordine:** 120 paia

**Scatola:** 120 paia - volume m<sup>3</sup> 0,10 - peso kg. 8

**Articolo dotato di codice a barre**



9 - 10



### art. 58F

art. 58F



CE

Guanto in filanca pesante candeggiato.

**Applicazione:** magazzino, elettronica, meccanica di precisione.

**Taglie:** 9 - 10

**Packing:** 48 paia

**Imballo minimo per ordine:** 48 paia

**Scatola:** 96 paia - volume m<sup>3</sup> 0,07 - peso kg. 7

**Articolo dotato di codice a barre e cartoncino espositore**



[EN420 CAT. 1]



9 - 10

### art. 58FL



CE

Guanto in filanca leggero candeggiato

**Applicazione:** magazzino, elettronica, meccanica di precisione.

**Taglie:** 10

**Packing:** 12 paia

**Imballo minimo per ordine:** 300 paia

**Scatola:** 300 paia - volume m<sup>3</sup> 0,12 - peso kg. 10

**Articolo dotato di codice a barre.**



[EN420 CAT. 1]



10



### art. 58DV



CE

Guanto in cotone a maglia a 3 capi - verde

**Taglie:** 8 - 9

**Tessuto:** Cotone

**Applicazione:** Sottoganto - Lavori di precisione

**Packing:** 12 paia confezionati singolarmente

**Imballo minimo per ordine:** 300 paia

**Scatola:** 300 paia - volume m<sup>3</sup> 0,07 - Kg. 6

**Articolo dotato di codice a barre e busta appendibile.**



[EN420 CAT. 1]



8 - 9



art. 58DB

[EN420 - CAT.1]



CE



Guanto in cotone a maglia a 3 capi - bianco  
**Taglie:** 8 - 9  
**Tessuto:** Cotone  
**Applicazione:** Sottoguanto - Lavori di precisione  
**Packing:** 12 paia confezionati singolarmente  
**Imballo minimo per ordine:** 300 paia  
**Scatola:** 300 paia - volume m<sup>3</sup> 0,07 - Kg. 6  
**Articolo dotato di codice a barre e busta appendibile**



8 - 9

art. 58D SC

[EN420 - CAT.1]



CE



Guanto in cotone a maglia a 3 capi -35 gr  
**Taglie:** 8 - 9 - 10  
**Tessuto:** Cotone  
**Applicazione:** Sottoguanto - Lavori di precisione  
**Packing:** 12 paia  
**Imballo minimo per ordine:** 300 paia  
**Scatola:** 300 paia - volume m<sup>3</sup> 0,07 - Kg. 6  
**Articolo dotato di codice a barre**



8 - 10

art. 58DG

[EN388 112X]



112X



CE



Guanto in polycotton 7G.  
**Taglia:** 8-9-10  
**Applicazione:** utilizzabile come sottoguanto, nei magazzini o nei lavori di precisione.  
**Packing:** 12 paia  
**Imballo minimo per ordine:** 120 paia  
**Scatola:** 120 paia - volume m<sup>3</sup> 0,08 - peso kg. 7  
**Articolo dotato di codice a barre.**



8 - 10

### art. 58DL



CE

Guanto in cotone a maglia a 2 capi - 30 gr

**Applicazione:** magazzino, elettronica, meccanica di precisione.

**Taglie:** 10

**Packing:** 12 paia

**Imballo minimo per ordine:** 300 paia

**Scatola:** 300 paia - volume m<sup>3</sup> 0,10 - peso kg. 10

**Articolo dotato di codice a barre.**



[EN420 CAT. 1]



10

### art. 58B



CE

Guanto in tela di cotone 8oz

**Taglie:** 9 - 10

**Tessuto:** Cotone

**Applicazione:** Sottoguanto - Lavori di precisione

**Packing:** 12 paia

**Imballo minimo per ordine:** 300

**Scatola:** 300 paia - volume m<sup>3</sup> 0,07 - Kg. 6

**Articolo dotato di codice a barre.**



[EN420 CAT. 1]



9 - 10

### art. 58P SC



CE

Guanto in cotone 100% cucito con polsino

**Taglie:** 9 - 10

**Tessuto:** Cotone

**Applicazione:** Sottoguanto - Lavori di precisione

**Packing:** 12 paia

**Imballo minimo per ordine:** 300 paia

**Scatola:** 300 paia - volume m<sup>3</sup> 0,07 - Kg. 6

**Articolo dotato di codice a barre**



[EN420 CAT. 1]



9 - 10

art. 58 SC

[EN420 CAT. 1]



Guanto in cotone 100% cucito

**Taglie:** 9 - 10

**Tessuto:** Cotone

**Applicazione:** Sottoguanto, lavori di precisione

**Packing:** 12 paia

**Imballo minimo per ordine:** 300 paia

**Scatola:** 300 paia - volume m<sup>3</sup> 0,07 - Kg. 6

**Articolo dotato di codice a barre.**



9 - 10

art. 58C SC

[EN420 CAT. 1]



Guanto in cotone cucito candeggiato

**Taglie:** 8 - 9 - 10

**Tessuto:** Cotone

**Applicazione:** Sottoguanto, lavori di precisione, vigili

**Packing:** 12 paia

**Imballo minimo per ordine:** 300 paia

**Scatola:** 300 paia - volume m<sup>3</sup> 0,07 - Kg. 6

**Articolo dotato di codice a barre.**



8 - 10

art. 58 CV

[EN420 CAT. 1]



Guanto in cotone candeggiato cucito per vigili e camerieri

**Taglie:** 9 - 10

**Tessuto:** Cotone

**Applicazione:** Sottoguanto, lavori di precisione, vigili, camerieri.

**Packing:** 12 paia

**Imballo minimo per ordine:** 120 paia

**Scatola:** 120 paia - volume m<sup>3</sup> 0,07 - Kg. 6

**Articolo dotato di codice a barre.**



9 - 10



art. 36

[EN388 4122 - EN ISO 10819]



4122



CE



Guanto antivibrazione in polycotton  
spalmato nel palmo in neoprene

**Taglia:** 10

**Applicazione:** utilizzo di martelli  
pneumatici, edilizia.

**Packing:** 12 paia

**Imballo minimo per ordine:** 12 paia

**Scatola:** 120 paia - volume m3 0,08 -  
peso kg. 8

**Articolo dotato di codice a barre e  
cartoncino espositore.**



10



## art. 53F

[EN388 2242 - EN407 42XX3X]

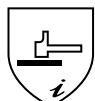

2242

CE



42XX3X



5

Guanto a 5 dita in tessuto kevlar®. Ottima resistenza al calore e all'abrasione. Lunghezza cm 27

**Taglia:** 10

**Tessuto:** KEVLAR®

**Applicazione:** industria pesante, fonderie.

**Packing:** 5 paia

**Imballo minimo per ordine:** 10 paia

**Scatola:** 10 paia - volume m<sup>3</sup> 0,05 - peso kg. 7

**Articolo dotato di codice a barre**



10



8 011818 120561



UNICA

## art. 53C

[EN388 2242 - EN407 42XX3X]

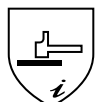

2242

CE



42XX3X



5

Guanto a 5 dita in fibra di carbonio-preox, doppio palmo. Lunghezza cm 38

**Taglia:** 10

**Tessuto:** fibra di carbonio - preox

**Applicazione:** industria pesante, fonderie.

**Packing:** 5 paia

**Imballo minimo per ordine:** 5 paia

**Scatola:** 5 paia - volume m<sup>3</sup> 0,07 - volume kg. 6

**Articolo dotato di codice a barre**



10



8 011818 120578



UNICA

## art. 53A

[EN388 2242 - EN407 42XX3X]

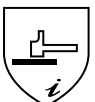

2242

CE



42XX3X



5

Guanto a 5 dita in tessuto kevlar®. Ottima resistenza al calore e all'abrasione. Lunghezza cm 45

**Taglia:** 10

**Tessuto:** KEVLAR®

**Applicazione:** industria pesante, fonderie.

**Packing:** 5 paia

**Imballo minimo per ordine:** 10 paia

**Scatola:** 10 paia - volume m<sup>3</sup> 0,05 - peso kg. 7

**Articolo dotato di codice a barre**



10



8 011818 120547



UNICA

## art. 13C

CE



Ghette in tessuto aramid. Ottima resistenza al calore e all'abrasione. Temperatura di esercizio 350°C, temperatura di punta 500°C. Altezza cm 30. Omologazione del tessuto

**Applicazione:** industria pesante, fonderie.

**Packing:** 1 paio

**Imballo minimo per ordine:** 1 paio

**Scatola:** 10 paia - volume m<sup>3</sup> 0,05 - peso kg. 7

**Articolo dotato di codice a barre**



## art. 7C

Parannanza in tessuto aramid. Ottima resistenza al calore e all'abrasione. Temperatura di esercizio 350°C, temperatura di punta 500°C. Omologazione del tessuto

**Dimensioni:** cm 60x100

**Tessuto:** aramid

**Applicazione:** industria pesante, fonderie.

**Packing:** 1 pezzo

**Imballo minimo per ordine:** 1 pezzo

**Scatola:** 1 pezzi - volume m<sup>3</sup> 0,05 - peso kg 2

**Articolo dotato di codice a barre**

CE



600x100  
cm



## art. 453A

Coperta antifiamma m 2x1

**Tessuto:** tessuto di vetro ignifugo

**Applicazione:** industria

**Packing:** in busta da 1 pezzo

**Imballo minimo per ordine:** 1 pezzo

**Scatola:** 1 pezzo - volume m<sup>3</sup> 0,03 - peso kg 2

**Articolo dotato di codice a barre**

CE



UNICA



art. 820

[EN388 454X + EN407 X2XXXX]

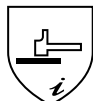

454X



X2XXXX



12

Guanto in tessuto antitaglio, lunghezza cm 28.

**Taglie:** 9-10

**Tessuto:** antitaglio

**Applicazione:** metallurgia, industria dell'alluminio, dello zinco

(manipolazione di parti taglienti e non sbavate);

- industria della carta e cartone;
- industria del vetro;
- produzione della plastica;
- produzione di ceramica;
- industria conciaria (taglio e assemblaggio);
- immagazzinaggio e manutenzione;
- edilizia;
- lavori ambientali;
- manipolazione di parti metalliche e plastiche

**Packing:** 12 paia

**Imballo minimo per ordine:** 12 paia

**Scatola:** 120 paia - volume m<sup>3</sup> 0,08 - kg 6

**Articolo dotato di codice a barre**



CE



9



8 011818 147698

10



8 011818 147704



9 - 10

art. 43E

[EN388 2344 - EN407 43XXXX]

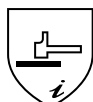

2344



43XXXX



5

CE

Manopola a 1 dito in fibra di carbonio-preox, doppio palmo. Lunghezza cm 38

**Taglia:** 10

**Tessuto:** fibra di carbonio - preox

**Applicazione:** industria pesante, fonderie.

**Packing:** 5 paia

**Imballo minimo per ordine:** 5 paia

**Scatola:** 5 paia - volume m<sup>3</sup> 0,07 -

volume kg. 6

**Articolo dotato di codice a barre**



10



8 011818 120639



UNICA

art. 43D

[EN388 2343 - EN 407 43XX4X]

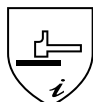

2343



43XX4X



5

CE

Guanto a 5 dita in fibra di carbonio-preox, doppio palmo. Lunghezza cm 38

**Taglia:** 10

**Tessuto:** fibra di carbonio - preox

**Applicazione:** industria pesante, fonderie.

**Packing:** 5 paia

**Imballo minimo per ordine:** 5 paia

**Scatola:** 5 paia - volume m<sup>3</sup> 0,07 - volume kg. 6

**Articolo dotato di codice a barre**



10



8 011818 120622



UNICA

## art. 43F

[EN388 2342 EN407 X34XXX]



2342



X34XXX



# CE

Guanto anticalore fino a 350°C  
resistente anche a liquidi  
- cm 40

**Taglia:** 10

**Tessuto:** anticalore

**Applicazione:** industria  
pesante, fonderie.

**Packing:** 1 paio

**Imballo minimo per ordine:**

1 paio

**Scatola:** 36 paia - volume m<sup>3</sup>  
0,15 - peso Kg. 10

**Articolo dotato di codice a  
barre e busta appendibile.**



10



UNICA





art. 450A

art. 451A

art. 454A

art. 452A

art. 453A

### art. 450A

[EN 11611 - EN11612]



Casco con visiera rivestito in tessuto di aramid alluminizzato

**Taglia:** unica regolabile

**Tessuto:** aramid alluminizzato

**Applicazione:** industria

**Packing:** in busta da 1 pezzo

**Imballo minimo per ordine:** 1 pezzo

**Scatola:** 5 pezzi - volume m<sup>3</sup> 0,08 - peso kg 5

**Articolo dotato di codice a barre**



### art. 451A

[EN 11611 - EN11612]



Giacca in tessuto di aramid alluminizzato

**Taglie:** unica

**Tessuto:** aramid alluminizzato

**Applicazione:** industria

**Packing:** in busta da 1 pezzo

**Imballo minimo per ordine:** 1 pezzo

**Scatola:** 5 pezzi - volume m<sup>3</sup> 0,08 - peso kg 5

**Articolo dotato di codice a barre.**



### art. 454A

[EN12477  
CE EN 407 42223X - EN388 3243]



3243



42223X



Guanto in tessuto aramid alluminizzato

**Taglia:** 10

**Tessuto:** aramid alluminizzato

**Applicazione:** industria

**Packing:** in busta da 1 paio

**Imballo minimo per ordine:** 1 paio

**Scatola:** 10 paia per taglia - volume m<sup>3</sup> 0,10 - peso kg 3

**Articolo dotato di codice a barre**



## art. 452A

[EN 11611 - EN11612]



Pantalone in tessuto di aramid alluminizzato

**Taglie:** Unica

**Tessuto:** aramid alluminizzato

**Applicazione:** industria

**Packing:** in busta da 1 paio

**Imballo minimo per ordine:** 1 paio

**Scatola:** 5 paia - volume m<sup>3</sup> 0,08 - peso kg 5

**Articolo dotato di codice a barre**

CE



UNICA



8 011818 125450

## art. 453B

[EN 11611 - EN11612]



Calzare in tessuto

**Taglia:** unica

**Tessuto:** aramid alluminizzato

**Applicazione:** industria

**Packing:** in busta da 1 paio

**Imballo minimo per ordine:** 1 paio

**Scatola:** 5 paia - volume m<sup>3</sup> 0,07 - peso kg 4

**Articolo dotato di codice a barre.**

CE



UNICA



8 011818 125429



## art. 492 MAPA

[EN420 - EN374 AJKL- EN388 4101]



4101

Guanto in nitrile, interno floccato cotone, lunghezza cm 32, spessore mm 0,38.

**Applicazione:** lavaggio di pezzi con presenza di olio da taglio, industria automobilistica, sgrassatura dei metalli, produzione e applicazione di pitture e vernici, trattamento dei metalli con solventi, pulizia di cilindri per stampa, trattamento e finitura del legno, preparazione di alimenti nel settore agroalimentare e nella ristorazione

**Imballo minimo per ordine:** 100 paia

**Scatola:** 100 paia - volume m<sup>3</sup> 0,10 - peso Kg. 10

**Articolo dotato di codice a barre**



CE

8,5



8 011818 124200

9,5



8 011818 124217

6,5



8 011818 124187

10



8 011818 124224

7,5



8 011818 124194

11



8 011818 124231



6,5 - 11

## art. 405 MAPA

[CE 0334 - EN420 - EN374 - EN388 2120]

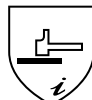

2120

Guanto in neoprene, lattice, floccato internamente, lunghezza cm 33, spessore mm 0,7.

**Applicazione:** pulizie industriali, levigatura, decapaggio, lavori di manutenzione, produzione di materiali da costruzione

**Imballo minimo per ordine:** 100 paia

**Scatola:** 100 paia - volume m<sup>3</sup> 0,10 - peso Kg. 10

**Articolo dotato di codice a barre**



CE

7,5



8 011818 126808

8,5



8 011818 126815

9,5



8 011818 126822

6,5



8 011818 126792

10,5



8 011818 126839



6,5 - 10,5

## art. 415 MAPA

[CE 0334 - EN 420 - EN374 - EN388 2011]



0 3 3 4

CE

Guanto in lattice misto, interno floccato, lunghezza cm 32, spessore mm 0,60.

**Applicazione:** pulizie industriali, levigatura, decapaggio, manutenzione, produzione materiale da costruzione, gesso, cemento

**Packing:** 50 paia

**Imballo minimo per ordine:** 100 paia

**Scatola:** 100 paia - volume m<sup>3</sup> 0,09 - peso Kg. 9

**Articolo dotato di codice a barre**



8,5



8 011818 124125

9,5



8 011818 133233

10



8 011818 132779

7,5



8 011818 124118

11



8 011818 135114



7,5 - 11



## art. 301 MAPA

[EN420 - EN374 - EN388 3141 - EN407 X1XXXX]

CE



3141



X1XXXX

Guanto in lattice naturale, con supporto interno tessile, lunghezza cm 33, spessore mm 1,15.

**Applicazione:** manipolazione di prodotti congelati, orticoltura, allevamento di pollame, miticoltura, fabbricazione inchiostri

**Imballo minimo per ordine:** 50 paia  
**volume m³ 0,10 - peso Kg. 9**  
**Articolo dotato di codice a barre**



10

6,5 - 10,5

## art. 401 MAPA

[EN420 - EN374 AKL - EN388 2110]

CE



2110



Guanto in neoprene, interno floccato, cm 31, spessore mm 0,55.

**Applicazione:** manipolazione chimica, industriale, fertilizzanti e concimi, trattamento del cuoio, fabbricazione abrasivi applicati, fabbricazione accumulatori elettrici, fabbricazione e installazione di forni, preparazione di colle industriali.

**Imballo minimo per ordine:** 100 paia  
**Scatola:** 100 paia - volume m³ 0,10 - peso Kg.10  
**Articolo dotato di codice a barre**



10



7 - 10



## art. 450 MAPA

[EN420 - EN374 AJKL - EN388 3121]

CE



3121



Guanto in neoprene, interno floccato, cm 41 spessore mm 0,75.

**Applicazione:** manipolazione chimica, industriale, fertilizzanti e concimi, trattamento del cuoio, fabbricazione abrasivi applicati, fabbricazione accumulatori elettrici, fabbricazione e installazione di forni, preparazione di colle industriali.

**Imballo minimo per ordine:** 50 paia  
**Scatola:** 50 paia - volume m³ 0,10 - peso Kg. 10  
**Articolo dotato di codice a barre**



10



7,5 - 10,5

**Fornibile a richiesta  
tutta la gamma MAPA®**

**MAPA®**  
PROFESSIONNEL

## art. 553 MAPA

[EN420 - EN388 4121]

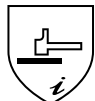

4121



10

CE



Guanto in nitrile spalmato su nylon  
**Imballo minimo per ordine:** 100 paia  
**Scatola:** 100 paia - volume m<sup>3</sup> 0,10 - peso Kg. 10  
**Articolo dotato di codice a barre**



## art. 355F - 47400

[CE EN 420 - EN388 3111]

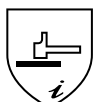

3111



12

CE

Guanto Hylite® in nitrile, dorso aerato, polso maglia, fodera di cotone che non irrita la pelle. Senza siliconi.

**Applicazione:** maneggio e ispezione di piccoli componenti e parti di motori, edilizia; gas e energia elettrica, manutenzione, raccolta dei rifiuti, maneggio di lamiere e pezzi di metallo leggeri, stampaggio, ricezione e spedizione merci.

**Imballo minimo per ordine:** 144 paia  
**Articolo dotato di codice a barre**



## art. 76 - 27607

[CE EN 420 EN 388 4221]



4221



12

CE

Guanto Hycron®, blu, rivestito in nitrile, dorso aerato, manicotto in tela.

**Imballo minimo per ordine:** 144 paia  
**Articolo dotato di codice a barre**



## art. 77 - 27600

[CE EN 420 EN 388 4221]



4221



CE



Guanto Hycron®, blu, rivestito in nitrile, **dorso aerato**, polso a maglia.  
**Imballo minimo per ordine** : 144 paia  
**Articolo dotato di codice a barre**



8 - 10

## art. 77 TS - 27602

[CE EN 420 EN 388 4221]



4221



CE



Guanto Hycron®, blu, completamente rivestito in nitrile, polso a maglia.  
**Imballo minimo per ordine** : 144 paia  
**Articolo dotato di codice a barre**



8 - 10

## art. 76 TS - 27805

[CE EN 420 EN 388 4221]



4221



CE



Guanto Hycron®, blu, completamente rivestito in nitrile, manicotto in tela.  
**Imballo minimo per ordine** : 144 paia  
**Articolo dotato di codice a barre**



9 - 11

## art. 355AE - 47409

[CE EN 420 EN 388 3111]



3111



12

CE

Guanto Hylite® in composto nitrilico che assicura un'eccellente combinazione di flessibilità, resistenza meccanica e oleorepellenza. Grazie alla sua forma anatomica, questo guanto si lascia portare agevolmente per lunghi periodi. Lunghezza cm. 29

**Imballo minimo per ordine** : 144 paia  
**Articolo dotato di codice a barre**



9



8 011818 164084

10



8 011818 151626



9 - 10

## art. 77M - 52547

[CE EN 420 - EN388 3111]

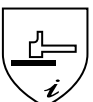

3111



12

CE

Guanto Hyd-Tuf® impregnato con nitrile ad alte prestazioni. Fodera morbida e flessibile in cotone jersey. Ottima presa asciutta. Garantiti senza siliconi. Manichetta di sicurezza. Lunghezza mm. 280

**Applicazione:** montaggio di piccoli componenti e pezzi metallici; industria automobilistica; distribuzione di gas metano e elettricità uso sulle piattaforme petrolifere in alto mare; maneggio di semilavorati in metallo e di pezzi di fusione leggeri, stampaggio ad iniezione, industria estrattiva, azionamento di macchinario, magazzino.

**Imballo minimo per ordine:** 144 paia  
**Articolo dotato di codice a barre**



9



8 011818 139662

10



8 011818 130850



9 - 10

## art. 358 - 42474

[CE EN 420 EN 388 2241 - EN407 X2XXXX]

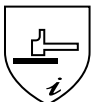

2241



X2XXXX



12

CE

Guanto Crusader® - Fodera di feltro " non tessuto" rivestita in nitrile ad altissima resistenza al calore. Lunghezza mm.330

**Applicazione:** maneggio di manufatti caldi in vetro, industria della gomma, rimozione dei manufatti dagli stampi, pneumatici, cinture di trasmissione e profilati in gomma, vulcanizzazione, calandratura, estrazione dagli stampi di manufatti in materiali termoplastici, maneggio di pezzi di fonderia, maneggio di pannelli di legno caldi, rimozione di prodotti sterilizzati in autoclave

**Imballo minimo per ordine** : 72 paia  
**Articolo dotato di codice a barre**



UNICA 10



8 011818 151718



UNICA 10

# art. 366C - 11800

[EN 388 3131]



3131



12

CE

Guanto Hyflex® foam , grigio, dita aerate  
**Imballo minimo per ordine** : 144 paia  
**Articolo dotato di codice a barre**



7 - 10

# art. 355AB - 48101

[CE EN 420 - EN388 4131]



4131



12

CE

Guanto Sensilite® leggero in poliuretano nero. Eccellente destrezza, resistenza all'abrasione, per manipolazione fine e molto sporchevole.

**Applicazione** : assemblaggio, ispezione e imballaggio di pezzi e componenti di piccole dimensioni, operazioni leggere di assemblaggio.

**Imballo minimo per ordine**:144 paia  
**Articolo dotato di codice a barre**



7 - 11

# art. 353AB - 78101

[CE EN 420 - EN388 214X - EN407 X1XXXX - EN511 - 010]



214X



X1XXXX



010



12

CE

Guanto termico A-Knit® leggero ed elasticizzato adatto a tutte le condizioni di lavoro in ambiente freddo - Lunghezza: 240 mm

**Applicazione** : l'impiego di fibre cave garantisce un migliore isolamento termico e una maggiore ritenzione del calore. La rapida eliminazione della sudorazione favorita dalle fibre tessili mantiene il calore corporeo. Utilizzabile sia come guanto che come sottoguanto. Lavabile a 40° C.

**Imballo minimo per ordine**: 144 paia  
**Articolo dotato di codice a barre**



7 - 9

## art. 355D - 92500

[EN374-AQL 1,5]



CE



Guanto Touch & Tuff® monouso in nitrile verde per maneggio di sostanze chimiche, ultrasottile, spessore 0,12 mm, ambidestro, trattamento con polvere antisudore. Disegno complesso, eccezionale resistenza all'abrasione. Lunghezza mm. 240 - cat. III

**Applicazione:** adatti per lavori che richiedono una buona sensibilità di presa e di tatto, per es. per l'industria farmaceutica, lavori con fibre di vetro, montaggio di piccoli componenti, protezione di prodotti, lavori di pulizia e manutenzione, ecc. La resistenza a oli/grassi è ridotta.

**Packing:** 100 pz.

**Imballo minimo per ordine:** 10 conf. da 100 pz

**Articolo dotato di codice a barre**



BOX 100



7 - 10

## art. 366E - 92670

[EN374-AQL 1,5]



CE



Guanto TNT BLUE monouso in nitrile blu. Spessore 0,10 mm. Senza polvere. Prodotto con un'innovativa formulazione di nitrile che offre eccellenti proprietà chimiche e meccaniche, nonché comfort e destrezza alle mani - Non contiene lattice naturale, tre volte più resistente alla perforazione del lattice o dei guanti usa e getta in PVC. Lunghezza mm. 240 - cat. III

**Applicazione:** adatti per lavori che richiedono una buona sensibilità di presa e di tatto, per es. per l'industria farmaceutica, lavori con fibre di vetro, montaggio di piccoli componenti, protezione di prodotti, lavori di pulizia e manutenzione, ecc

**Packing:** 100 pz

**Imballo minimo per ordine:** 10 conf. da 100 pz

**Articolo dotato di codice a barre**



BOX 100



7 - 10

## art. 360A - 37675

[CE EN 420 EN 388 4101 - EN374-JKL]

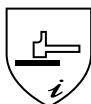

CE

4101



Guanto Solvex plus® in nitrile, spessore 0,38mm., lunghezza mm. 380

**Applicazioni:** industria chimica e raffinazione del petrolio, operazione di sgrassatura dell'industria aeronautica e automobilistica. Lavorazione dei metalli, fabbricazione di batterie e componenti elettronici.

**Imballo minimo per ordine:**

144 paia

**Articolo dotato di codice a barre**



12



7 - 11

# art. 366F - 87955

[EN 388 X121 EN374 AKL]



X121



12

CE

Guanto Extra 75® in lattice pesante adatto a lavori gravosi e pesanti. Spessore superiore del 50% rispetto ai guanti felpati standard. Lunghezza cm. 32. Altissima resistenza a numerosi chetoni, sali, detergenti, alcool, alcali e grassi.

**Applicazione:** industria chimica, raffinazione, manutenzione di impianti ed attrezzature pesanti.

**Imballo minimo per ordine:**

144 paia

**Articolo dotato di codice a barre**



7,5



8 011818 153507

8,5



8 011818 132649

9,5



8 011818 124514

10



8 011818 124521



7,5 - 10

# art. 355C - 37900

[CE EN420 - EN388 4102 EN374]



4102



12

CE

Guanti Solvex® con nuova formulazione nitrilica ad alte prestazioni che alza livelli di sicurezza per il maneggio dei prodotti chimici ad alto rischio. Ogni guanto viene collaudato individualmente con aria compressa per accertarne la perfetta tenuta. Il più basso indice AQL (Livello medio di qualità) nell'industria: 0,065

**Applicazione:** il film nitrilico di nuova formulazione garantisce una maggiore robustezza e un'eccellente resistenza ad una più vasta gamma di sostanze chimiche

**Lunghezza:** mm.380

**Colore:** rosso

**Imballo minimo per ordine:** 72 paia

**Articolo dotato di codice a barre**



7



8 011818 124712

8



8 011818 124729

9



8 011818 124736

10



8 011818 124743



7 - 10

# art. 355AD - 25201

[CE 0493 - EN374 AQL 1,5]



BOX 100

CE

Guanti in Neoprene, multiuso, senza polvere, ideale per protezione dalle allergie Tipo I, eccellente resistenza ad acidi, basi e alcoli, ottimo confort. Finitura ruvida sulla punta delle dita - colore verde.

**Applicazioni:** industria chimica e raffinazione del petrolio, operazione di sgrassatura dell'industria aeronautica e automobilistica. Lunghezza mm. 290. Lavorazione dei metalli, fabbricazione di batterie e componenti elettronici.

**Imballo minimo per ordine:** 10 dispenser da 100 pezzi

**Articolo dotato di codice a barre**



7



8 011818 154320

8



8 011818 151978

9



8 011818 151985



7 - 9

## art. 366 - 87600

[CE EN 420 - EN 388 X010 EN374 - EN421 ]

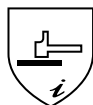

CE

X010



12

Guanti di lattice Duzmor 45® leggeri e aderenti, con forma anatomica ottimale - colore beige naturale, spessore 0,43 mm, profilo antisdrucchiolo non vellutati sul lato interno, lunghezza 30 cm

**Applicazione:** adatti per lavori che richiedono una buona sensibilità di presa e di tatto, per es. per l'industria farmaceutica, lavori con fibre di vetro, montaggio di piccoli componenti, protezione di prodotti, lavori di pulizia e manutenzione, ecc. La resistenza a oli/grassi è ridotta.

**Imballo minimo per ordine:** 144 paia  
**Articolo dotato di codice a barre**



7



8 011818 151749

8



8 011818 141115

9



8 011818 134186

10



8 011818 134179



7 - 10

## art. 90BA - 29500

[CE EN 420 EN 388 3121 - EN 374 - AKL ]

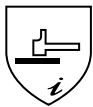

CE

3121



Guanto Neotop®, nero, neoprene lunghezza mm. 300.

Spessore 0,75mm

**Applicazione:** industrie chimiche, agricoltura, raffinerie, pulizie e manutenzione.

**Imballo minimo per ordine:** 144 paia  
**Articolo dotato di codice a barre**



7,5



8 011818 154290

8,5



8 011818 151602

9,5



8 011818 131512

10



8 011818 151619

11



8 011818 164749



7,5 - 11

**Fornibile a richiesta  
 tutta la gamma ANSELL®**





GLOVES

GUANTI

GLOVES



GLOVES



SEBA

# INDICE

NORME ABBIGLIAMENTO .....	pag. 82
GIACCONI - GIUBBOTTI - GILET .....	pag. 86
GIUBBETTI E GILET LEGGERI.....	pag. 98
SOFT SHELL .....	pag. 105
FELPE - TEMPO LIBERO .....	pag. 108
POLO - T-SHIRT .....	pag. 116
CAPPELLI.....	pag. 119
INDUMENTI ANTIPIOGGIA .....	pag. 122
PARANNANZE .....	pag. 126
ABITI DA LAVORO.....	pag. 128
ALTA VISIBILITÀ.....	pag. 175



SEBA



# ABBIGLIAMENTO ABBIGLIAMENTO

## WORKWEAR



SEBA

## Normative EN

### EN 14404:2005

#### Dispositivi di protezione individuale - Protettori delle ginocchia per lavori in posizione inginocchiata.

La norma specifica i requisiti dei protettori delle ginocchia per l'utilizzo in posizione inginocchiata.

### EN 340:2003 - EN ISO 13688:2013

#### Indumenti di protezione - Requisiti generali.

Vengono disciplinati i requisiti generali per ergonomia, invecchiamento, taglie e marcatura degli indumenti di protezione. I capi devono essere progettati e fabbricati offrendo al portatore il massimo grado di comfort. Le componenti e i materiali utilizzati non devono causare effetti indesiderati all'utilizzatore, quali allergie, irritazioni o lesioni. La gamma di taglie deve essere rappresentativa delle misure del corpo.



### EN ISO 20471:2013

#### Indumenti di segnalazione ad alta visibilità per uso professionale - Requisiti e metodi di prova.

Ogni indumento alta visibilità è certificato secondo la tabella di cui sotto in base alle aree minime di materiale fluorescente, che permette maggiore visibilità di giorno, e banda retroriflettente della luce artificiale (fari di automobile) che permette maggiore visibilità di notte.

**X:** classe dell'area del materiale di fondo e retroriflettente (vedi tabella 1, classe da 1 a 3)

AREE MINIME DI MATERIALE VISIBILE	INDUMENTI DI CLASSE 3	INDUMENTI DI CLASSE 2	INDUMENTI DI CLASSE 1
Materiale di fondo fluorescente (m <sup>2</sup> )	0,80 m <sup>2</sup>	0,50 m <sup>2</sup>	0,14 m <sup>2</sup>
Materiale retroriflettente (m <sup>2</sup> )	0,20 m <sup>2</sup>	0,13 m <sup>2</sup>	0,10 m <sup>2</sup>

La norma prevede di abbinare a completo due capi certificati alta visibilità in modo tale da raggiungere una classe superiore, alla quale corrisponde un maggiore livello di protezione.



### EN 342:2004

#### Indumenti di protezione - Completi e indumenti per la protezione contro il freddo.

Questa normativa specifica i requisiti per tute intere e completi composti da due pezzi che proteggono da ambienti freddi, caratterizzati dalla combinazione di umidità e vento ad una temperatura dell'aria inferiore a -5 °C. Le imbottiture specifiche e i particolari accorgimenti tecnici permettono al capo di respirare e allo stesso tempo di mantenere al caldo l'utilizzatore.

**X:** Valore d'isolamento termico su uomo in movimento

**Y:** Valore d'isolamento termico su uomo fermo (facoltativo)\*

**Z:** classe di permeabilità dell'aria (classe da 1 a 3)

**W:** classe di impermeabilità del capo (facoltativo)\* (classe da 1 a 2)

\*Se l'indumento non è stato sottoposto a uno dei test facoltativi la relativa marcatura sarà contrassegnata con X.



### UNI EN 343:2008

#### Indumenti di protezione - protezione contro la pioggia.

Questa normativa specifica i requisiti applicabili ai materiali e alle cuciture degli indumenti di protezione dalle influenze delle precipitazioni (pioggia, neve), nebbia e umidità del suolo. I capi sono progettati e costruiti utilizzando materiali impermeabili e traspiranti, prestando particolare attenzione alla sigillatura di tutte le cuciture, per garantire un ottimo livello di comfort.

**X:** classe di impermeabilità del capo (classe da 1 a 3)

**Y:** classe di traspirabilità del capo (classe da 1 a 3)



### EN ISO 11612:2008

#### Indumenti di protezione - protezione contro fiamma e calore.

Questa normativa specifica la prestazione degli indumenti progettati per proteggere tutto il corpo dal calore e dalle fiamme, specifica i requisiti per tute intere e completi composti da due pezzi, attraverso l'utilizzo di materiali specifici e definiti requisiti di progettazione, a garantire un livello di prestazioni rispondente alla norma e disciplinati da diversi valori di resistenza al calore. Il capo può essere conforme anche se non ha valori di riferimento da B a W.

**A:** propagazione della fiamma

**B:** calore convettivo (classe 1-3)

**C:** calore radiante (classe 1-4)

**D:** schizzi di alluminio fuso (classe 1-3)

**E:** schizzi di acciaio fuso (classe 1-3)

**F:** calore da contatto (classe 1-3)

**W:** resistenza alla penetrazione di acqua (classe 1-3)



## EN ISO 14116:2008

### Requisiti prestazionali dei materiali.

Questa normativa specifica i requisiti prestazionali dei materiali, degli assemblaggi di materiale e degli indumenti di protezione a propagazione di fiamma limitata allo scopo di ridurre la possibilità che un indumento bruci, rappresentando in tal modo un pericolo esso stesso.



INDICE 1	INDICE 2	INDICE 3	PROPRIETÀ	REQUISITO
X	X	X	Propagazione di fiamma	Per nessun provino il fronte inferiore della fiamma deve raggiungere il bordo superiore o verticale
X	X	X	Residui infiammati	Nessun provino deve generare residui infiammati
X	X	X	Incandescenza residua	Nessuna incandescenza residua, dopo la cessazione delle fiamme, deve propagarsi dalla zona carbonizzata a quella intatta
	X	X	Formazione di fori	Nessun provino deve presentare la formazione di un foro
		X	Combustione residua	La durata della combustione residua di ogni singolo provino non deve essere maggiore di 2 s



Classe

## EN ISO 11611:2007

### Indumenti di protezione - protezione per saldature e procedimenti connessi.

Questa normativa specifica la prestazione e i requisiti minimi di sicurezza degli indumenti progettati per proteggere il corpo da scintille, schizzi di metallo fuso e gocce, prodotte durante saldature e procedimenti connessi.

**Classe 1:** Tecniche di saldatura manuale con lieve formazione di schizzi e gocce

**Classe 2:** Tecniche di saldatura manuale con forte formazione di schizzi e gocce

**A1 o A2:** Propagazione della fiamma



## CEI EN 61482-1-2:2008

### Indumenti di protezione - protezione contro i rischi termici di un arco elettrico.

Questa normativa specifica la prestazione degli indumenti progettati per proteggere tutto il corpo contro i rischi termici di un arco elettrico dovuto a cortocircuito accidentale ed inaspettato in impianti elettrici. Nel metodo 1-2: camera di prova con arco elettrico e forzato la prova è effettuata secondo 2 classi in base alla corrente di cortocircuito presunta.

Tensione di prova 400 V c.a. Durate dell'arco 500 ms

**Classe 1:** il capo garantisce il minimo livello di protezione dall'arco termico. Corrente di prova 4 KA

**Classe 2:** il capo garantisce il più alto livello di protezione dall'arco termico. Corrente di prova 7 KA



## EN 1149-5:2008

### Indumenti di protezione - protezione contro le cariche elettrostatiche.

La norma specifica i requisiti del materiale e di progettazione per gli indumenti di protezione che dissipano le cariche elettrostatiche, utilizzati come parte di un sistema di messa a terra totale per evitare scariche che possano innescare incendi.

Indumento protettivo contro le cariche elettrostatiche



## Direttiva EU 1999/92/CE - ATEX (ATmospheres EXplosibles)

La Direttiva EU 1999/92/CE (direttiva ATEX) prescrive le misure per la tutela della sicurezza e della salute dei lavoratori che possono essere esposti al rischio di atmosfere esplosive. I capi COFRA Hazard, Ring, Emergency soddisfano tutti i requisiti inerenti ai materiali e alla progettazione richiesti dalla norma UNI EN 1149-5 (indumenti con proprietà antistatiche) evitando che scariche elettrostatiche possano innescare incendi, quindi rendendo il capo idoneo all'utilizzo negli ambienti ATEX.



## EN 13034:2005+A1:2009

### Indumenti di protezione - protezione contro gli agenti chimici liquidi.

Questa normativa specifica la prestazione e i requisiti minimi di sicurezza degli indumenti progettati per offrire una protezione limitata contro agenti chimici liquidi.

**A1:** Resistenza alla penetrazione.



TIPO 3B

## EN 14605:2005+A1:2009

### Indumenti di protezione contro agenti chimici liquidi.

La norma specifica i requisiti minimi per gli indumenti di protezione a tenuta di liquido (Tipo 3) o a tenuta di spruzzi (Tipo 4). Rispetto agli indumenti di tipo 6 (protezione da schizzi liquidi) questa norma considera la possibilità che l'operatore, soprattutto nei casi di emergenza, venga a contatto con il contaminante per un tempo prolungato ed in una quantità notevolmente superiore (test di permeazione).



TIPO 4



SEBA



## EN ISO 13982-1:2004 +A1:2010

### Indumenti di protezione per l'utilizzo contro particelle solide

La norma specifica i requisiti minimi per indumenti di protezione contro prodotti chimici resistenti alla penetrazione di particelle solide disperse nell'aria (tipo 5).



## EN 14126:2003

### Requisiti prestazionali e metodi di prova per gli indumenti di protezione contro gli agenti infettivi.

Indumenti che provvedono alla protezione del corpo in ambienti in cui la valutazione dei rischi evidenzia la presenza e la possibilità di contatto della pelle con agenti biologici pericolosi quali ad esempio virus, batteri, funghi, ecc.



## EN 1073-2:2002

### Indumenti di protezione contro la contaminazione radioattiva.

La norma specifica i requisiti e i metodi di prova per gli indumenti di protezione non ventilati che proteggono il portatore dalla contaminazione radioattiva sotto forma di particelle. Viene rilevato il fattore di protezione nominale (100/TILA) dove TILA è la perdita totale di tenuta verso l'interno ossia il rapporto, fornito in percentuale, tra le concentrazioni delle particelle all'interno dell'indumento e quella all'interno della camera di prova. In base al valore ricavato la tuta verrà classificata così come riportato in tabella.

Classe	Valore medio della perdita di tenuta verso l'interno nell'indumento in 3 posizioni e durante tutte le attività (TILA)	Fattore di protezione nominale 100/ TILA
3	0,2	500
2	2	50
1	20	-

## SCelta DEL CAPO

Le misure sono espresse in cm e si riferiscono ai capi finiti

TAGLIA	GIROVITA	TORACE	ALTEZZA
44 - S	84 - 88	104 - 108	164 - 170
46 - M	84 - 88	108 - 112	164 - 170
48 - M	84 - 88	112 - 116	170 - 176
50 - L	92 - 96	116 - 120	170 - 176
52 - L	92 - 96	120 - 124	176 - 182
54 - XL	104 - 108	124 - 128	176 - 182
56 - XL	104 - 108	128 - 132	176 - 182
58 - XXL	108 - 112	132 - 136	176 - 182
60 - XXL	112 - 116	136 - 140	182 - 188
62 - XXXL	116 - 120	140 - 144	182 - 188

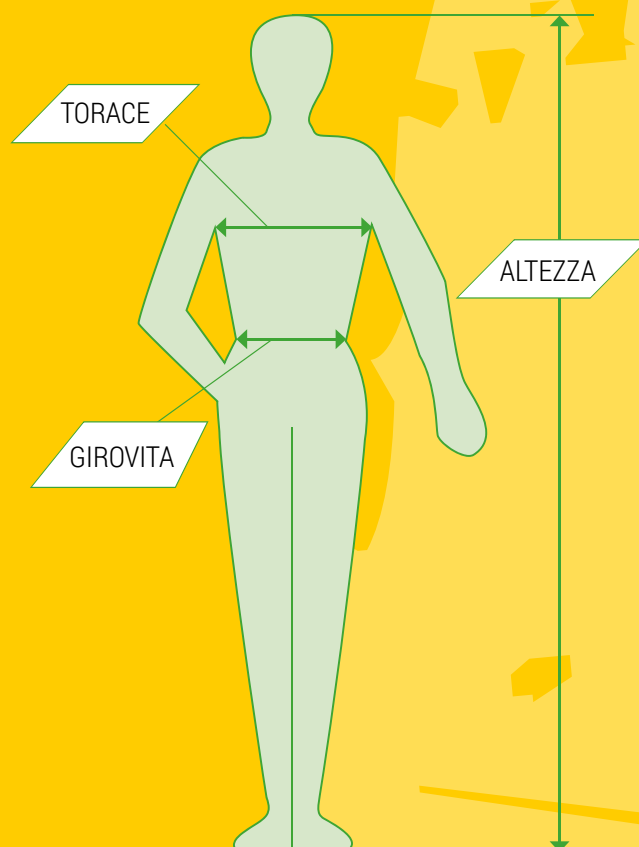



# SETTORI DI UTILIZZO

- |                                       |                                   |                      |
|---------------------------------------|-----------------------------------|----------------------|
| INDUSTRIA ALIMENTRE<br>RISTORAZIONE   | RESISTENZA A<br>BASSE TEMPERATURE | OFFICINA MECCANICA   |
| ANTITAGLIO                            | AGRICOLTURA<br>GIARDINAGGIO       | LAVORI DI PRECISIONE |
| ANTIFIAMMA<br>RESISTENZA AL CALORE    | INDUSTRIA                         | PULIZIE              |
| CANTIERI NAVALI                       | LAVORAZIONI PESANTI               | SALDATURA            |
| INDUSTRIA CHIMICA<br>FARMACEUTICA     | CANTIERI STRADALI                 | TEMPO LIBEO          |
| CANTIERI E LAVORI EDILI               | MAGAZZINO                         | TRASPORTI            |
| INDUSTRIA ELETTRONICI<br>ELETTRICISTI | MECCANICA                         | TAGLIE               |

# LEGENDA SIMBOLI

## COMPOSIZIONE TESSUTI

- |                    |                     |                            |
|--------------------|---------------------|----------------------------|
| 100% COTONE        | LAVAGGIO A MACCHINA | CENTRIFUGA PER ASCIUGATURA |
| ELASTICIZZATO      | STIRATURA           | MAX NUMERO LAVAGGI AMMESSI |
| COMPOSIZIONE MISTA | LAVAGGIO A SECCO    |                            |
| SINTETICO          | LAVAGGIO CON CLORO  |                            |

# PRODOTTI PERSONALIZZABILI

E' possibile realizzare capi di abbigliamento personalizzati su richiesta del cliente in diversi tessuti, colori con inserimento di loghi e personalizzazione.



## art. 950B

[CE - Cat.1]



Giacca imbottita idrorepellente e traspirante in tessuto antistrappo MAXTEX - Cappuccio a scomparsa.

**Taglie:** M L XL XXL XXXL

**Applicazione:** edilizia, magazzini, industria, tempo libero.

**Imballo minimo per ordine:** 1 paio

**Volume scatola:** 0,10 m3 - 20 pezzi - peso kg. 10

**Articolo dotato di codice a barre.**



M-XXXL

## art. 802

[CE - Cat.1]



Gilet imbottito idrorepellente e traspirante in tessuto antistrappo MAXTEX - Cappuccio a scomparsa.

**Taglie:** M L XL XXL XXXL

**Applicazione:** edilizia, magazzini, industria, tempo libero.

**Imballo minimo per ordine:** 1 paio

**Volume scatola:** 0,10 m3 - 20 pezzi - peso kg. 9

**Articolo dotato di codice a barre.**



M-XXXL



## art. 950NB



[CE - Cat.1]



Giacca imbottita idrorepellente e traspirante in tessuto antistrappo MAXTEX - Cappuccio a scomparsa.

**Taglie :** M L XL XXL XXXL

**Applicazione :** edilizia, magazzini, industria, tempo libero.

**Imballo minimo per ordine:** 1 paio

**Volume scatola:** 0,10 m3 - 20 pezzi - peso kg. 10

**Articolo dotato di codice a barre.**

M-XXXL

## art. 803



[CE - Cat.1]



Gilet imbottito idrorepellente e traspirante in tessuto antistrappo MAXTEX - Cappuccio a scomparsa.

**Taglie :** M L XL XXL XXXL

**Applicazione :** edilizia, magazzini, industria, tempo libero.

**Imballo minimo per ordine:** 1 paio

**Volume scatola:** 0,10 m3 - 20 pezzi - peso kg. 9

**Articolo dotato di codice a barre.**

M-XXXL

art. 950BG

[CE - Cat.1]



Giubbotto in tessuto MAXTEX, multitasche, impermeabile e traspirante.  
 Maniche staccabili.  
 Cappuccio interno a scomparsa  
**Taglia:** M-L-XL-XXL  
**Applicazione:** edilizia  
**Imballo minimo per ordine:** 1 pezzo  
**Scatola:** 10 pezzi - volume m<sup>3</sup> 0,10 Kg.10  
**Articolo dotato di codice a barre**

  
 M-XXL

art. 801

[CE - Cat.1]



Gilet imbottito idrorepellente e traspirante in tessuto antistrappo MAXTEX - Cappuccio a scomparsa.  
**Taglie:** M L XL XXL XXXL  
**Applicazione:** edilizia, magazzini, industria, tempo libero.  
**Imballo minimo per ordine:** 1 paio  
**Volume scatola:** 0,10 m<sup>3</sup> - 20 pezzi - peso kg. 9  
**Articolo dotato di codice a barre.**

  
 M-XXXL

## art. 900NBG



[CE - Cat.1]



Gilet in tessuto MAXTEX, multitasche, impermeabile e traspirante. Interno in pile. Cappuccio interno a scomparsa

**Taglia:** M-L-XL-XXL

**Applicazione:** industria

**Imballo minimo per ordine:** 1 pezzo

**Scatola:** 10 pezzi - volume m<sup>3</sup> 0,10 Kg.8

**Articolo dotato di codice a barre**

  
M-XXL

## art. 700SVC



[CE - Cat.1]



Giaccone in tessuto MAXTEX, multitasche, impermeabile e traspirante. Interno trapuntato staccabile ed utilizzabile separatamente. Cappuccio interno a scomparsa.

**Colore:** grigio-nero c/inserti color arancio

**Taglie:** M-L-XL-XXL - XXXL

**Applicazione:** edilizia, magazzinaggio.

**Imballo minimo per ordine:** 1 pezzo

**Volume scatola:** 0,10 m<sup>3</sup> (10 pezzi)

Peso kg. 10

**Articolo dotato di codice a barre**

  
M-XXL

## art. 900NTC

[CE - Cat.1]

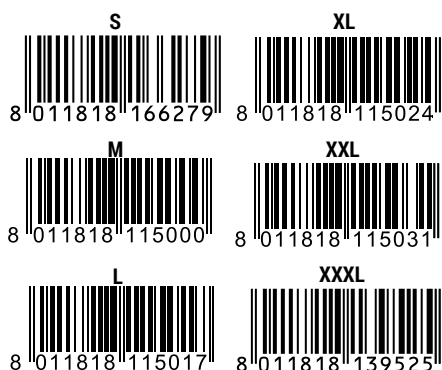

GILET in tessuto MAXTEX, multitasche, impermeabile e traspirante con portabadge. Interno in pile. Cappuccio interno a scomparsa.

**Colore:** grigio-nero c/inserti color arancio

**Taglie:** S-M-L-XL-XXL-XXXL

**Applicazione:** edilizia, magazzino.

**Articolo dotato di codice a barre**

**Imballo minimo per ordine:** 1 pezzo

**Volume scatola:** 0,10 m<sup>3</sup> (10 pezzi) Peso kg. 8

**Articolo dotato di codice a barre**

S-XXXL

## art. 700SVB

[CE - Cat.1]

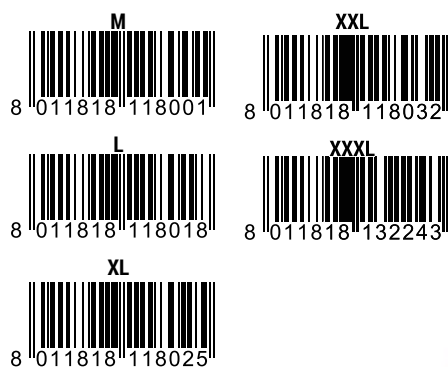

Giaccone in tessuto MAXTEX, multitasche, impermeabile e traspirante. Interno trapuntato staccabile ed utilizzabile separatamente. Cappuccio interno a scomparsa.

**Colore:** blu-nero c/inserti color arancio

**Taglie:** M-L-XL-XXL - XXXL

**Applicazione:** industria.

**Imballo minimo per ordine:** 1 pezzo

**Volume scatola:** 0,10 m<sup>3</sup> (10 pezzi)

Peso kg. 10

**Articolo dotato di codice a barre**

M-XXXL

## art. 950SVB



Giubbotto HOT STUFF in tessuto MAXTEX, multitasche, impermeabile e traspirante. Maniche staccabili. Cappuccio interno a scomparsa  
**Taglia:** M-L-XL-XXL  
**Applicazione:** industria  
**Imballo minimo per ordine:** 1 pezzo  
**Scatola:** 10 pezzi - volume m<sup>3</sup> 0,10 Kg.10  
**Articolo dotato di codice a barre**

[CE - Cat.1]



  
M-XXL

## art. 900NTB



GILET HOT STUFF ® in tessuto MAXTEX, multitasche, impermeabile e traspirante. Interno in pile. Cappuccio interno a scomparsa.  
**Colore:** blu-nero c/inserti color arancio  
**Taglie:** M-L-XL-XXL  
**Applicazione:** industria.  
**Articolo dotato di codice a barre**  
**Imballo minimo per ordine:** 1 pezzo  
**Volume scatola:** 0,10 m<sup>3</sup> (10 pezzi) Peso kg. 8

[CE - Cat.1]



  
M-XXL

## art. 700GM

[CE - Cat.1]



Giaccone invernale impermeabile in 190T pongee spalmato in pvc.

Cappuccio staccabile

**Taglie:** M-L-XL-XXL-XXXL

**Tessuto:** pongee/pvc

**Interno:** pile

**Imbottitura:** 100% poliestere gr. 180/m<sup>2</sup>

**Applicazione:** edilizia, magazzini, industria, tempo libero

**Packing:** in busta da 1 pezzo

**Imballo minimo per ordine:** 1 pezzo

**Scatola:** 10 pezzi per taglia - volume m<sup>3</sup> 0,12 - peso kg 10

**Articolo dotato di codice a barre**

  
M-XXXL

## art. 950GM

[CE - Cat.1]



Giubbotto imbottito con cappuccio,

particolari riflettenti, parte esterna nylon taslon oxford spalmato in pvc. Parte interna poliestere taffeta 190T

**Taglie:** M-L-XL-XXL-XXXL

**Tessuto:** nylon taslon/pvc

**Imbottitura:** 100% poliestere gr. 180/m<sup>2</sup>

**Applicazione:** edilizia, magazzini, industria, tempo libero

**Packing:** in busta da 1 pezzo

**Imballo minimo per ordine:** 1 pezzo

**Scatola:** 10 pezzi per taglia volume m<sup>3</sup> 0,10 - peso kg 7

**Articolo dotato di codice a barre**

  
M-XXXL

## art. 700TM

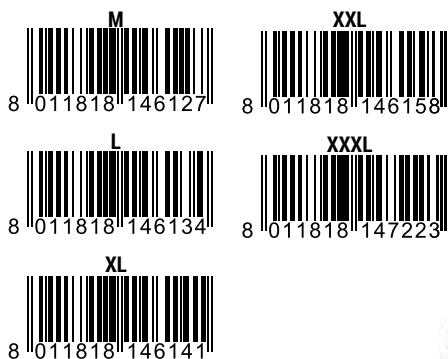

Giacca invernale idrorepellente in nylon 228T taslon, con cappuccio. Interno trapuntato staccabile.

**Taglie:** M-L-XL-XXL-XXXL

**Tessuto:** nylon

**Imbottitura:** 100% poliestere

**Applicazione:** edilizia, magazzini, industria, tempo libero

**Packing:** in busta da 1 pezzo

**Imballo minimo per ordine:** 1 pezzo

**Scatola:** 10 pezzi per taglia - volume m<sup>3</sup> 0,10 - peso kg 7

**Articolo dotato di codice a barre.**



[CE - Cat.1]



 M-XXXL

## art. 957BG



Gilet estivo idrorepellente in nylon 185T taslon, rete interna traspirante, colore verde scuro

**Taglie:** M-L-XL-XXL-XXXL

**Tessuto:** nylon

**Applicazione:** edilizia, magazzini, industria, tempo libero

**Packing:** in busta da 1 pezzo

**Imballo minimo per ordine:** 10 pezzi

**Scatola:** 20 pezzi per taglia - volume m<sup>3</sup> 0,10 - peso kg 6

**Articolo dotato di codice a barre.**



[CE - Cat.1]



 M-XXXL

## art. 106NS

[CE - Cat.1]



Giacca 4 usi multitasche, reversibile con maniche asportabili.

Parte esterna 300D poliestere oxford spalmato in pvc, parte interna pile gr. 360/m<sup>2</sup> anti-pilling.

**Taglie:** M-L-XL-XXL-XXXL

**Tessuto:** poliestere oxford/pile

**Applicazione:** edilizia, magazzini, industria, tempo libero

**Packing:** in busta da 1 pezzo

**Imballo minimo per ordine:** 1 pezzo

**Scatola:** 10 pezzi per taglia - volume m<sup>3</sup> 0,12 - peso kg 8

**Articolo dotato di codice a barre**



REVERSIBILE - DOUBLE FACE

REVERSIBILE - DOUBLE FACE  
CON MANICHE ASPORTABILI



M-XXXL



art. 100S3 - B

[CE - Cat.1]



Dettaglio parte interna



8 011818 100600



8 011818 100624



8 011818 100617



8 011818 100631

Parka bicolore impermeabile imbottito, triplo uso.  
Husky interno con fodera scozzese. Maniche staccabili

**Taglie:** M-L-XL-XXL

**Tessuto:** nylon spalmato in PVC con cuciture termosaldate

**Imbottitura:** 100% poliestere

**Applicazione:** edilizia - industria - magazzini

**Packing:** in busta da 1 pezzo

**Imballo minimo per ordine:** 1 pezzo

**Scatola:** 10 pezzi per taglia - volume m<sup>3</sup> 0,15  
peso kg 10

**Articolo dotato di codice a barre**



M-XXL

## art. 800SF

[CE - Cat.1]



Gilet imbottito impermeabile in nylon/pvc

**Taglie:** M-L-XL-XXL-XXXL

**Tessuto:** nylon/pvc

**Imbottitura:** 100% poliestere con fodera in nylon 190T

**Applicazione:** edilizia, magazzini, industria, tempo libero

**Packing:** in busta da 1 pezzo

**Imballo minimo per ordine:** 1 pezzo

**Scatola:** 10 pezzi per taglia - volume m<sup>3</sup> 0,10 - peso kg 7

**Articolo dotato di codice a barre**



M-XXXL

## art. 956N

[CE - Cat.1]



Gilet multitasche in cotone poliestere. Colore nero.

**Taglie:** M-L-XL-XXL

**Tessuto:** cotone / poliestere

**Applicazione:** edilizia - industria - magazzini

**Packing:** in busta da 1 pezzo

**Imballo minimo per ordine:** 5 pezzi

**Scatola:** 20 pezzi per taglia - volume m<sup>3</sup> 0,10 - peso kg 20

**Articolo dotato di codice a barre**



M-XXL

## art. 957B ●

[CE - Cat.1]

P/C



Gilet multitasche in cotone poliestere.  
 Colore blu.

**Taglie:** M-L-XL-XXL

**Tessuto:** cotone / poliestere

**Applicazione:** edilizia - industria - magazzini

**Packing:** in busta da 1 pezzo

**Imballo minimo per ordine:** 5 pezzi

**Scatola:** 20 pezzi per taglia - volume m<sup>3</sup> 0,10 - peso kg 20

**Articolo dotato di codice a barre**



M-XXL

## art. 957M ●

P/C



Gilet 9 tasche leggero in cotone/poliestere con tasca porta badge. Chiusura frontale con bottoni + cerniera. Retina interna.

**Taglie:** M-L-XL-XXL

**Tessuto:** Cotone/poliestere

**Applicazione:** edilizia. industria

**Fodera interna:** in retina traspirante.

**Packing:** in busta da 1 pezzo

**Imballo minimo per ordine:** 1 pezzo

**Scatola:** 10 pezzi per taglia - volume m<sup>3</sup> 0,10 - peso kg 8

**Articolo dotato di codice a barre**



M-XXL



## art. 900FLUO

[CE - Cat.1]



Gilet sportivo impermeabile con cappuccio, in nylon taffeta 20D; fode interna in nylon taffeta 210, soffice imbottitura interna. 2 tasche laterali

**Taglie:** S - M L XL XXL XXXL

**Applicazione:** edilizia, magazzini, agricoltura, tempo libero.

**Imballo minimo per ordine:** 1 paio

**Volume scatola:** 0,10 m3 - 20 pezzi - peso kg. 8

**Articolo dotato di codice a barre.**



S-XXXL



## art 900R



[CE - Cat.1]



Gilet sportivo impermeabile con cappuccio staccabile, in nylon taffeta 20D; fode interna in nylon taffeta 210, soffice imbottitura interna. 2 tasche laterali

**Taglie :** S - M L XL XXL XXXL

**Applicazione :** edilizia, magazzini, agricoltura, tempo libero.

**Imballo minimo per ordine:** 1 paio

**Volume scatola:** 0,10 m<sup>3</sup> - 20 pezzi - peso kg. 8

**Articolo dotato di codice a barre.**

S-XXXL



## art. 900NE

[CE - Cat.1]



Gilet impermeabile in nylon taffeta 20D, fodera interna in nylon taffeta 210, sofficina imbottitura in cotone 100% - 2 tasche laterali.

**Taglie :** S L XL XXL XXXL

**Applicazione :** edilizia, magazzini, tempo libero.

**Imballo minimo per ordine:** 1 pz

**Volume scatola:** 0,09 m3 - 20 pezzi - peso kg. 8

**Articolo dotato di codice a barre.**



S - XXXL

## art. 700NE

[CE - Cat.1]



S - XXXL

Giacca impermeabile in nylon taffeta 20D, fodera interna in nylon taffeta 210, sofficina imbottitura in cotone 100% - 2 tasche laterali.

**Taglie :** S L XL XXL XXXL

**Applicazione :** edilizia, magazzini, tempo libero.

**Imballo minimo per ordine:** 1 pz

**Volume scatola:** 0,10 m3 - 20 pezzi - peso kg. 10

**Articolo dotato di codice a barre.**

## art. 900BE

[CE - Cat.1]



Gilet impermeabile in nylon taffeta 20D, fodera interna in nylon taffeta 210, sofficina imbottitura in cotone 100% - 2 tasche laterali.

**Taglie :** S L XL XXL XXXL

**Applicazione :** edilizia, magazzini, tempo libero.

**Imballo minimo per ordine:** 1 pz

**Volume scatola:** 0,09 m3 - 20

pezzi - peso kg. 8

**Articolo dotato di codice a barre.**

S - XXXL

## art. 700BE

[CE - Cat.1]



Giacca impermeabile in nylon taffeta 20D, fodera interna in nylon taffeta 210, sofficina imbottitura in cotone 100% - 2 tasche laterali.

**Taglie :** S L XL XXL XXXL

**Applicazione :** edilizia, magazzini, tempo libero.

**Imballo minimo per ordine:** 1 pz

**Volume scatola:** 0,10 m3 - 20

pezzi - peso kg. 10

**Articolo dotato di codice a barre.**

S - XXXL

## art. 950MIM



Giacca mimetica impermeabile con cappuccio, in nylon taffeta 20D; fodera interna in nylon taffeta 210, soffice imbottitura interna. 2 tasche laterali  
**Taglie** : S M L XL XXL XXXL  
**Applicazione** : edilizia, magazzini, agricoltura, tempo libero.  
**Imballo minimo per ordine**: 1 paio  
**Volume scatola**: 0,10 m3 - 20 pezzi - peso kg. 9  
**Articolo dotato di codice a barre.**

  
S-XXXL

## art. 900MIM



Gilet mimetico impermeabile senza cappuccio, in nylon taffeta 20D; fodera interna in nylon taffeta 210, soffice imbottitura interna. 2 tasche laterali  
**Taglie** : S M L XL XXL XXXL  
**Applicazione** : edilizia, magazzini, agricoltura, tempo libero.  
**Imballo minimo per ordine**: 1 paio  
**Volume scatola**: 0,10 m3 - 20 pezzi - peso kg. 9  
**Articolo dotato di codice a barre.**

  
S-XXXL



## art. 700BL



Giacca imbottita leggera e confortevole  
- idrorepellente e traspirante - Cappuccio staccabile.

**Taglie :** S M L XL XXL XXXL

**Applicazione :** edilizia, magazzini, industria, tempo libero.

**Imballo minimo per ordine:** 1 paio

**Volume scatola:** 0,10 m3 - 20 pezzi - peso kg. 9

**Articolo dotato di codice a barre.**



[CE - Cat.1]



S-XXXL

## art. 106F

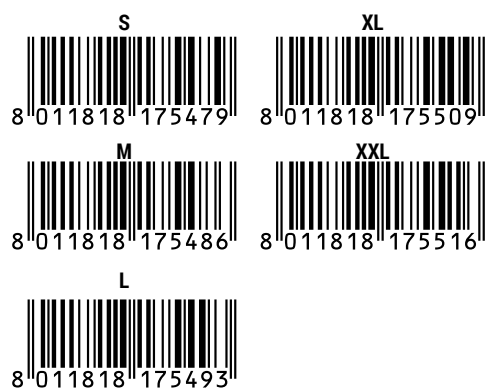

Giubbino in poliestere pongee, spalmatura in PVC, imbottitura e fodera in poliestere. Maniche staccabili, tasca sul petto con portabadge a scomparsa. Fondo vita con elastico

**Taglie:** S- M-L-XL-XXL

**Applicazione:** magazzini, industria

**Packing:** in busta da 1 pezzo

**Imballo minimo per ordine:** 5 pezzi

**Scatola:** 5 pezzi per taglia  
volume m3 0,05 - peso kg 4

**Articolo dotato di codice a barre**



[CE - Cat.1]



S-XXL



## art. 952MIM



[CE - Cat.1]



Giacca imbottita mimetica idrorepellente  
94% poliestere, 6 % spandex, fodera interna  
in Poliestere taffeta.

Particolari riflettenti nel giro-spalla.

**Taglie :** M - L - XL - XXL - XXXL

**Applicazione :** edilizia, magazzini, tempo libero.

**Imballo minimo per ordine:** 1 paio

**Volume scatola:** 0,10 m3 - 20 pezzi - peso kg. 9

**Articolo dotato di codice a barre.**



M-XXXL

## art. 955S



[CE - Cat.1]



Giacca SOFTSHELL idrorepellente - 100%  
poliestere, membrana interna in TPU

**Taglie :** M L XL XXL

**Applicazione :** edilizia, magazzini, industria,  
tempo libero.

**Imballo minimo per ordine:** 1 pz

**Volume scatola:** 0,10 m3 - 20 pezzi - peso kg. 9

**Articolo dotato di codice a barre.**



M-XXL

## art. 900S

[CE-Cat.1]



Gilet SOFTSHELL senza cappuccio - 96% poliestere, 4 % spandex, con interno in pile peso gr. 270 M2

**Taglie :** M L XL XXL XXXL

**Applicazione :** edilizia, magazzini, industria, tempo libero.

**Imballo minimo per ordine:** 1 paio

**Volume scatola:** 0,10 m3 - 20 pezzi - peso kg. 8

**Articolo dotato di codice a barre.**

  
M-XXXL

## art. 954S

[CE-Cat.1]



Giacca SOFTSHELL con cappuccio staccabile - 96% poliestere, 4 % spandex, con interno in pile - peso gr. 270 M2

**Taglie :** M L XL XXL XXXL

**Applicazione :** edilizia, magazzini, industria, tempo libero.

**Imballo minimo per ordine:** 1 paio

**Volume scatola:** 0,10 m3 - 20 pezzi - peso kg. 8

**Articolo dotato di codice a barre.**

  
M-XXXL

## art. 953S



[CE - Cat.1]



Giacca SOFTSHELL senza cappuccio - 96% poliestere, 4 % spandex, con interno in pile - peso gr. 270 M2

**Taglie :** M L XL XXL XXXL

**Applicazione :** edilizia, magazzini, industria, tempo libero.

**Imballo minimo per ordine:** 1 paio

**Volume scatola:** 0,10 m3 - 20 pezzi - peso kg. 8

**Articolo dotato di codice a barre.**

M-XXXL

## art. 952S



[CE - Cat.1]



Giacca SOFTSHELL idrorepellente - 94% poliestere, 6 % spandex, membrana interna in TPU - Particolari riflettenti nella tasca superiore ed inferiori.

**Taglie :** M L XL XXL XXXL

**Applicazione :** edilizia, magazzini, industria, tempo libero.

**Imballo minimo per ordine:** 1 paio

**Volume scatola:** 0,10 m3 - 20 pezzi - peso kg. 9

**Articolo dotato di codice a barre.**

M-XXXL

art. 898CT

[CE - Cat.1]



Felpe cotone/poliestere - peso 320 gr.m2 - porta badge fisso laterale. Due tasche a marsupio  
**Taglie :** M L XL XXL XXXL  
**Applicazione :** edilizia, magazzini, industria, tempo libero.  
**Imballo minimo per ordine:** 1 pz  
**Volume scatola:** 0,08 m3 - 20 pezzi - peso kg. 8  
**Articolo dotato di codice a barre.**

M-XXXL

art. 898CN

[CE - Cat.1]



Felpe cotone/poliestere - peso 300 gr.m2  
 Due tasche a marsupio - Con cappuccio.  
**Taglie :** M L XL XXL  
**Applicazione :** edilizia, magazzini, industria, tempo libero.  
**Imballo minimo per ordine:** 1 pz  
**Volume scatola:** 0,08 m3 - 20 pezzi - peso kg. 8  
**Articolo dotato di codice a barre.**

M-XXL

## ● art. 898-3U01

## ● art. 898-3U01VE

[CE-Cat.1]

P/C



Felpe girocollo con elastico in vita

**Taglie:** S-M-L-XL-XXL

**Tessuto:** cotone/poliestere

**Applicazione:** industria, edilizia, agricoltura, tempo libero.

**Packing:** in busta da 1 pezzo

**Imballo minimo per ordine:** 1 pezzo

**Scatola:** 20 pezzi per taglia  
volume m<sup>3</sup> 0,10 - peso kg 8

**Articolo dotato di codice a barre**

  
S-XXL

## art. 898 3G

[CE-Cat.1]

P/C



Giubbotto in felpe con cerniera corta frontale  
colore grigio. Elastico ai polsi e in vita.

Cuciture ribattute

**Taglie:** S-M-L-XL-XXL

**Tessuto:** cotone/poliestere

**Applicazione:** industria, edilizia, agricoltura, tempo libero.

**Packing:** in busta da 1 pezzo

**Imballo minimo per ordine:** 1 pezzo

**Scatola:** 20 pezzi per taglia  
volume m<sup>3</sup> 0,08 - peso kg 8

**Articolo dotato di codice a barre**

  
S-XXL

## art. 898 3

[CE-Cat.1]

P/C



Giubbotto in felpa con cerniera corta frontale  
colore blu. Elastico ai polsi e in vita.

Cuciture ribattute

**Taglie:** S-M-L-XL-XXL

**Tessuto:** cotone/poliestere

**Applicazione:** industria, edilizia,  
agricoltura, tempo libero.

**Packing:** in busta da 1 pezzo

**Imballo minimo per ordine:** 1 pezzo

**Scatola:** 20 pezzi per taglia  
volume m<sup>3</sup> 0,08 - peso kg 8

**Articolo dotato di codice a barre**



S-XXL

## art. 898 3V

[CE-Cat.1]

P/C



Giubbotto in felpa con cerniera corta frontale  
colore verde. Elastico ai polsi e in vita.

Cuciture ribattute

**Taglie:** S-M-L-XL-XXL

**Tessuto:** cotone/poliestere

**Applicazione:** industria, edilizia,  
agricoltura, tempo libero.

**Packing:** in busta da 1 pezzo

**Imballo minimo per ordine:** 1 pezzo

**Scatola:** 20 pezzi per taglia  
volume m<sup>3</sup> 0,08 - peso kg 8

**Articolo dotato di codice a barre**



S-XXL



WORKWEAR

art. 898RO

[CE - Cat.1]

P/C



Felpe bicolore in cotone / poliestere - gr. 280 mq con collo e polsini in contrasto. Chiusura frontale a bottoni

**Taglie:** M-L-XL-XXL

**Applicazione:** edilizia, magazzini, tempo libero.

**Packing:** in busta da 1 pezzo

**Imballo minimo per ordine :** 5 pezzo

**Scatola:** 20 pezzi per taglia - volume m3 0,08 - peso kg. 8

**Articolo dotato di codice a barre**



art. 898AZ

[CE - Cat.1]

P/C



Felpe bicolore in cotone / poliestere - gr. 280 mq con collo e polsini in contrasto. Chiusura frontale a bottoni

**Taglie:** M-L-XL-XXL

**Applicazione:** edilizia, magazzini, tempo libero.

**Packing:** in busta da 1 pezzo

**Imballo minimo per ordine :** 5 pezzo

**Scatola:** 20 pezzi per taglia - volume m3 0,08 - peso kg. 8

**Articolo dotato di codice a barre**



art. 103TG



Tuta ginnica grigia in cotone/poliestere.

**Taglie:** M-L-XL-XXL

**Tessuto:** poliestere/cotone

**Applicazione:** magazzini, tempo libero

**Packing:** in busta da 1 pezzo

**Imballo minimo per ordine:** 1 pezzo

**Scatola:** 15 pezzi per taglia - volume m<sup>3</sup> 0,10 - peso kg 9

**Articolo dotato di codice a barre**



art. 103TB



Tuta ginnica blue in cotone/poliestere.

**Taglie:** M-L-XL-XXL

**Tessuto:** poliestere/cotone

**Applicazione:** magazzini, tempo libero

**Packing:** in busta da 1 pezzo

**Imballo minimo per ordine:** 1 pezzo

**Scatola:** 15 pezzi per taglia - volume m<sup>3</sup> 0,10 - peso kg 9

**Articolo dotato di codice a barre**



## art. 898-2

[CE - Cat.1]

(S)



Giacca in pile blue con cerniera corta frontale  
**Taglie:** S - M-L-XL-XXL  
**Tessuto:** 100% poliestere  
**Applicazione:** industria, edilizia, agricoltura, tempo libero.  
**Packing:** in busta da 1 pezzo  
**Imballo minimo per ordine:** 1 pezzo  
**Scatola:** 20 pezzi per taglia - volume m<sup>3</sup> 0,10 - peso kg 8  
**Articolo dotato di codice a barre**

  
S-XXL

## art. 898PB

[CE - Cat.1]

(S)



Pantalone in pile. Coulisse in vita. Tasca posteriore  
**Taglie:** M-L-XL-XXL  
**Applicazione:** industria, edilizia, agricoltura, tempo libero.  
**Tessuto:** 100% poliestere  
**Packing:** in busta da 1 pezzo  
**Imballo minimo per ordine:** 1 pezzo  
**Scatola:** 20 pezzi per taglia - volume m<sup>3</sup> 0,10 - peso kg 8  
**Articolo dotato di codice a barre**

  
M-XXL

## art. 898HSB

[CE - Cat.1]

P/C



Felpe bicolore HOT STUFF® in 100 % cotone,  
peso gr. 260/m<sup>2</sup>

**Taglie:** M-L-XL-XXL-XXXL

**Tessuto:** cotone

**Applicazione:** edilizia, magazzini, tempo libero

**Packing:** in busta da 1 pezzo

**Imballo minimo per ordine:** 1 pezzo

**Scatola:** 10 pezzi per taglia - volume m<sup>3</sup> 0,10 -  
peso kg 7

**Articolo dotato di codice a barre**

M-XXXL



## art. 898GG

©



Felpe a mezza zip in cotone 100% - peso 290 gr.m2 - Tasca laterale con zip

**Taglie:** M L XL XXL XXXL

**Applicazione:** edilizia, magazzini, industria, tempo libero.

**Imballo minimo per ordine:** 1 pz

**Volume scatola:** 0,08 m3 - 20 pezzi - peso kg. 8

**Articolo dotato di codice a barre.**

  
M-XXXL

## art. 898PGG

©



Pantalone in tessuto felpato in cotone 100% - peso 290 gr.m2 - Due tasche laterali

**Taglie:** M L XL XXL XXXL

**Applicazione:** edilizia, magazzini, industria, tempo libero.

**Imballo minimo per ordine:** 1 pz

**Volume scatola:** 0,08 m3 - 20 pezzi - peso kg. 8

**Articolo dotato di codice a barre.**

  
M-XXXL

art. 466 - POLO

[CE - Cat. I]



Polo piquet in cotone a manica corta  
**Taglie:** S - M-L-XL-XXL  
**Tessuto:** 100% cotone peso gr 180 m<sup>2</sup>  
**Applicazione:** industria, edilizia, agricoltura, tempo libero.  
**Packing:** in busta da 1 pezzo  
**Imballo minimo per ordine:** 5 pezzi per taglia e/o multipli  
**Scatola:** 25 pezzi per taglia - volume m<sup>3</sup> 0,08 - peso kg 9  
**Articolo dotato di codice a barre**



S-XXL

○ art. 466BI

● art. 466BLR

● art. 466BL

● art. 466NE



● art. 466ME

● art. 466RO

● art. 466VE

● art. 466AR



## art. 466 - POLO MANICA LUNGA

[CE - Cat.1]

©



Polo piquet in cotone a manica lunga

**Taglie:** M-L-XL-XXL

**Tessuto:** 100% cotone peso gr 180 m<sup>2</sup>

**Applicazione:** industria, edilizia, agricoltura, tempo libero.

**Packing:** in busta da 1 pezzo

**Imballo minimo per ordine:** 5 pezzi per taglia e/o multipli

**Scatola:** 25 pezzi per taglia - volume m<sup>3</sup> 0,08 - peso kg 10

**Articolo dotato di codice a barre**



M-XXL

### ● art. 466MLMS

### ● art. 466MLB

### ● art. 466MLM



### ○ art. 463

©



T-shirt bianca in cotone - collo largo, doppio a 4 rib

**Taglie:** S-M-L-XL-XXL

**Tessuto:** 100% cotone peso gr 130 m<sup>2</sup>

**Applicazione:** industria, edilizia, agricoltura, tempo libero.

**Packing:** in busta da 12 pezzi ripiegati in due

**Imballo minimo per ordine:** 12 pezzi per taglia e/o multipli

**Scatola:** 120 pezzi per taglia - volume m<sup>3</sup> 0,10 - peso kg 14

**Articolo dotato di codice a barre**



S-XXL

[CE-Cat.1]

## art. 464 - T-SHIRT

C



T-shirt colorata – collo largo, doppio a 4 rib

**Taglie:** S-M-L-XL-XXL**Tessuto:** 100% cotone peso gr 130 m<sup>2</sup>**Applicazione:** industria, edilizia, agricoltura, tempo libero.**Packing:** in busta da 12 pezzi ripiegati in due  
**Imballo minimo per ordine:** 12 pezzi per taglia e/o multipli**Scatola:** 120 pezzi per taglia - volume m<sup>3</sup> 0,10 - peso kg 14**Articolo dotato di codice a barre**

S-XXL

## ● art. 464B

## ● art. 464BRL

## ● art. 464GI

## ● art. 464N



8 011818 149593



8 011818 105636



8 011818 105643



8 011818 105650



8 011818 105667



8 011818 135817



8 011818 114331



8 011818 114348



8 011818 114355



8 011818 114362



8 011818 169300



8 011818 105674



8 011818 105681



8 011818 105698



8 011818 105704



8 011818 154399



8 011818 105711



8 011818 105728



8 011818 105735



8 011818 105742

## ● art. 464MEL

## ● art. 464R

## ● art. 464V

## ● art. 464AR



8 011818 149579



8 011818 106077



8 011818 106084



8 011818 106091



8 011818 106107



8 011818 154412



8 011818 105513



8 011818 105520



8 011818 105537



8 011818 105544



8 011818 154405



8 011818 105551



8 011818 105568



8 011818 105575



8 011818 105582



8 011818 149586



8 011818 105599



8 011818 105605



8 011818 105612



8 011818 105629



## art. 14RA

[CE EN 812]

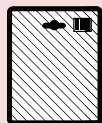

CE



UNICA  
8 011818 154368

Cappellino con supporto antiurto. Resistenza 12,5 Joule - Colore arancio

**Taglia:** unica regolabile

**Materiale:** poliestere/cotone + calotta in polietilene

**Applicazione:** edilizia, lavori stradali.

**Packing:** in busta da 1 pezzo

**Imballo minimo per ordine:** 1 pezzo

**Scatola:** 10 pezzi - volume m<sup>3</sup> 0,05 - peso kg 5

**Articolo dotato di codice a barre e confezione appendibile.**



UNICA

## art. 14FLUO



UNICA  
8 011818 123982

Cappellino invernale arancio ad alta visibilità con visiera e con banda riflettente reflexite.

**Taglia:** unica

**Tessuto:** cotone / poliestere

**Applicazione:** edilizia

**Packing:** in busta da 1 pezzo

**Imballo minimo per ordine:** 1 pezzo

**Scatola:** 12 pezzi - volume m<sup>3</sup> 0,07 - peso kg 5

**Codice a barre su richiesta**



UNICA

## art. 15FLUO



UNICA  
8 011818 133431

Cappellino estivo arancio ad alta visibilità con visiera e con banda riflettente reflexite

**Taglia:** unica

**Tessuto:** cotone / poliestere

**Applicazione:** edilizia

**Packing:** in busta da 1 pezzo

**Imballo minimo per ordine:** 1 pezzo

**Scatola:** 12 pezzi - volume m<sup>3</sup> 0,07 - peso kg 5

**Codice a barre su richiesta**



UNICA



art. 14R

[CE EN 812]



CE

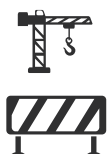

Cappellino con supporto antiurto. Resistenza 12,5 Joule - Colore Blue Navy

**Taglia:** unica regolabile

**Materiale:** poliestere/cotone + calotta in polietilene

**Applicazione:** industria, magazzini, edilizia

**Packing:** in busta da 1 pezzo

**Imballo minimo per ordine:** 1 pezzo

**Scatola:** 10 pezzi - volume m<sup>3</sup> 0,05 - peso kg 5

**Articolo dotato di codice a barre e confezione appendibile**

art. 13B



Cuffia blue in 100% acrilico.

**Taglia:** unica

**Tessuto:** 100% acrilico

**Interno:** foderato

**Applicazione:** edilizia, magazzini, industria, tempo libero

**Packing:** in busta da 1 pezzo

**Imballo minimo per ordine:** 10 pezzi

**Scatola:** 50 pezzi - volume m<sup>3</sup> 0,10 - peso kg 5

**Articolo dotato di codice a barre**

art. 14FV



Cappello invernale in nylon/PVC imbottito con copriorecchie.

**Taglia:** unica

**Tessuto:** nylon spalmato in PVC con cuciture termosaldate

**Imbottitura:** 100% poliestere

**Applicazione:** edilizia, industria

**Packing:** in busta da 1 pezzo

**Imballo minimo per ordine:** 1 pezzo

**Scatola:** 10 pezzi - volume m<sup>3</sup> 0,07 - peso kg 5

**Articolo dotato di codice a barre**

art. 14FB



Cappello invernale in nylon/PVC imbottito con copriorecchie.

**Taglia:** unica

**Tessuto:** nylon spalmato in PVC con cuciture termosaldate

**Imbottitura:** 100% poliestere

**Applicazione:** edilizia, industria

**Packing:** in busta da 1 pezzo

**Imballo minimo per ordine:** 1 pezzo

**Scatola:** 10 pezzi - volume m<sup>3</sup> 0,07 - peso kg 5

**Articolo dotato di codice a barre**

## CAPPELLO BASEBALL

©



Cappellino baseball 5 pannelli.

**Taglia:** unica regolabile

**Tessuto:** poliestere/cotone

**Applicazione:** tempo libero

**Packing:** in busta da 25 pezzi

**Imballo minimo per ordine:** 50 pz

**Scatola:** 150 pezzi - volume m<sup>3</sup> 0,10 - peso kg 10

**Articolo dotato di codice a barre**



UNICA

**art. 14AR - ARANCIO** ●



8 011818 137521

**art. 14EBR - BLUE ROYAL** ●



8 011818 123913

**art. 14EBI - BIANCO** ○



8 011818 123890

**art. 14EBL - BLUE NAVY** ●



8 011818 123906

**art. 14EG - GIALLO** ●



8 011818 123937

**art. 14EN - NERO** ●



8 011818 123951

**art. 14EV - VERDE** ●



8 011818 123944

## art. 103BPU

[CE - Cat.1]



PU

Giacca c/cappuccio e pantalone impermeabile.  
Coulisse in vita - Due tasche frontali basse.  
Bottoni frontali automatici + cerniera.

**Taglia:** M-L-XL-XXL

**Materiale:** PVC/POLIURETANO

**Applicazione:** industria, edilizia, agricoltura

**Packing:** 1 busta da 1 pezzo

**Imballo minimo per ordine:** 20 pezzi per taglia e/o multipli

**Scatola:** 20 pezzi - volume m<sup>3</sup> 0,08 Kg.30

**Articolo dotato di codice a barre**

  
M-XXL

## art. 103VPU

[CE - Cat.1]



PU

Giacca c/cappuccio e pantalone impermeabile.  
Coulisse in vita - Due tasche frontali basse.  
Bottoni frontali automatici + cerniera.

**Taglia:** M-L-XL-XXL

**Materiale:** PVC/POLIURETANO

**Applicazione:** industria, edilizia, agricoltura

**Packing:** 1 busta da 1 pezzo

**Imballo minimo per ordine:** 20 pezzi per taglia e/o multipli

**Scatola:** 20 pezzi - volume m<sup>3</sup> 0,08 Kg.30

**Articolo dotato di codice a barre**

  
M-XXL

## art. 103NV

**NYLON  
PVC**



[CE - Cat.1]



Giacca impermeabile con cappuccio estraibile, porta badge e pantalone con due tasche e bottoni automatici alle caviglie. Colore verde

**Taglie:** M-L-XL-XXL-XXXL

**Tessuto:** nylon/pvc

**Spessore:** 0,18 mm

**Applicazione:** industria, edilizia, agricoltura

**Packing:** in busta da 1 pezzo

**Imballo minimo per ordine:** 20 pezzi per taglia e/o multipli

**Scatola:** 20 pezzi per taglia - volume m<sup>3</sup> 0,10 - peso kg 20

**Articolo dotato di codice a barre**



M-XXXL

## art. 103N

**NYLON  
PVC**



[CE - Cat.1]



Giacca impermeabile con cappuccio estraibile, porta badge e pantalone con due tasche e bottoni automatici alle caviglie. Colore blu

**Taglie:** M-L-XL-XXL-XXXL

**Tessuto:** nylon/pvc

**Spessore:** 0,18 mm

**Applicazione:** industria, edilizia.

**Packing:** in busta da 1 pezzo

**Imballo minimo per ordine:** 20 pezzi per taglia e/o multipli

**Scatola:** 20 pezzi per taglia - volume m<sup>3</sup> 0,08 - peso kg 20

**Articolo dotato di codice a barre**



M-XXXL

## art. 104K

[CE - Cat.1]



## NYLON

Giacca tipo K-Way impermeabile in nylon con una tasca laterale (non foderato)

**Taglie:** M-L-XL-XXL

**Materiale:** poliestere/nylon

**Applicazione:** industria, edilizia, tempo libero.

**Packing:** in busta da 1 pezzo

**Imballo minimo per ordine:** 20 pezzi per taglia e/o multipli

**Scatola:** 20 pezzi per taglia - volume m<sup>3</sup> 0,08 - peso kg 9

**Articolo dotato di codice a barre**



M-XXL

## art. 103V

[CE - Cat.1]

PVC  
POLY  
PVC

Giacca c/cappuccio e pantalone impermeabile.

Couliisse in vita - Due tasche frontali basse.

Bottoni frontali automatici + cerniera.

**Taglia:** M-L-XL-XXL

**Materiale:** pvc/poliestere/pvc

**Applicazione:** industria, edilizia, agricoltura

**Packing:** 1 busta da 1 pezzo

**Imballo minimo per ordine:** 20 pezzi per taglia e/o multipli

**Scatola:** 20 pezzi - volume m<sup>3</sup> 0,08 Kg.30

**Articolo dotato di codice a barre**



M-XXL

## art. 103G

[CE - Cat.1]



### PVC - POLY - PVC

Giacca c/cappuccio e pantalone impermeabile.  
Coulisse in vita - Due tasche frontali basse.  
Bottoni frontali automatici + cerniera.

**Taglia:** M-L-XL-XXL-XXXL

**Materiale:** pvc/poliestere/pvc

**Applicazione:** industria, edilizia

**Packing:** 1 busta da 1 pezzo

**Imballo minimo per ordine:** 20 pezzi per taglia e/o multipli

**Scatola:** 20 pezzi - volume m<sup>3</sup> 0,08 Kg.30

**Articolo dotato di codice a barre**

  
M-XXXL

## art. 68B



Impermeabile trasparente tascabile in polietilene.  
Confezione: in borsetta trasparente

**Taglie:** uomo - donna

**Applicazione:** industria, edilizia, tempo libero.

**Packing:** 60 pezzi per taglia

**Imballo minimo per ordine:** 120 pezzi per taglia e/o multipli

**Scatola:** 120 pezzi per taglia - volume m<sup>3</sup> 0,10 - peso kg 8

**Articolo dotato di codice a barre**

  
DONNA  
  
UOMO

**art. 91PL**

Grembiule in polietilene  
**Dimensione:** cm 70x125  
**Applicazione:** edilizia – industria magazzini  
**Packing:** in scatola da 1000 pz.  
**Imballo minimo per ordine:** 1000 pezzi  
**Scatola:** 1000 pezzi - volume m<sup>3</sup> 0,10 - peso kg 5  
**Articolo dotato di codice a barre**



**art. 016**

Parannanza in cotone  
**Misura:** cm 60 x 90  
**Tessuto:** 100% cotone peso gr 240 m<sup>2</sup> - restringimento max 2%  
**Applicazione:** edilizia – industria magazzini  
**Packing:** 10 pezzi  
**Imballo minimo per ordine:** 40 pezzi  
**Scatola:** 40 pezzi - volume m<sup>3</sup> 0,07 - peso kg 5  
**Articolo dotato di codice a barre**



**art. 300B**

[EN 467]

CE



Grembiule in poliuretano per grassi animali - colore bianco. Resistente al calore fino a 85° C.  
**Dimensione:** cm 90 x 115  
**Spessore:** mm 0,35  
**Applicazione:** edilizia – industria – magazzini  
**Packing:** in busta da 1 pezzo  
**Imballo minimo per ordine:** 1 pezzo  
**Scatola:** 10 pezzi - volume m<sup>3</sup> 0,07 - peso kg 7  
**Articolo dotato di codice a barre**





## art. 105 - GREMBIULE



Grembiule con rinforzo nella parte centrale pvc/  
poliestere/pvc

**Materiale:** pvc/poliestere/pvc rinforzato nella  
parte centrale

**Spessore:** mm.0,32 - Rinforzo interno mm. 0,50

**Applicazione:** edilizia - industria - magazzini-  
alimentare

**Packing:** 10 pezzi

**Imballo minimo per ordine:** 20 pezzi

**Scatola:** 10 pezzi - volume m<sup>3</sup> 0,07 - peso kg 7

**Articolo dotato di codice a barre**



UNICA

### art. 105 BI

BIANCO - 75x100 cm



8 011818 104837

### art. 105 VE

VERDE - 75x100 cm



8 011818 104899

### art. 105 GI

GIALLO - 75x100 cm



8 011818 104868

### art. 105A BI

BIANCO - 75x120 cm



8 011818 104844

### art. 105A VE

VERDE - 75x120 cm



8 011818 104905

### art. 105A GI

GIALLO - 75x120 cm



8 011818 104875

### art. 105B BI

BIANCO - 90x120 cm



8 011818 104851

### art. 105B VE

VERDE - 90x120 cm



8 011818 104912

### art. 105B GI

GIALLO - 90x120 cm



8 011818 104882

art. 460MIM

[CE - Cat.1]

(E)



Giacca in tessuto twill di cotone 97% - elastam 3% con particolari mimetici - Peso gr. 250  
Retina interna antisudore.

**Taglie :** S M L XL XXL XXXL

**Applicazione :** edilizia, magazzini, tempo libero.

**Imballo minimo per ordine:** 1 pz

**Volume scatola:** 0,08 m3 - 20 pezzi - peso kg. 9

**Articolo dotato di codice a barre e confezione appendibile.**



art. 458MIM

[CE - Cat.1]

(E)



Pantalone con pettorina in tessuto twill di cotone 97% - elastam 3% - con particolari mimetici - Peso gr. 250

**Taglie :** M L XL XXL XXXL

**Applicazione :** edilizia, magazzini, tempo libero.

**Imballo minimo per ordine:** 1 pz

**Volume scatola:** 0,08 m3 - 20 pezzi - peso kg. 9

**Articolo dotato di codice a barre e confezione appendibile.**



WORKWEAR

art. 146MIM

[CE-Cat.1]

(E)



Bermuda in tessuto twill di cotone 97% - elastam 3% - con particolari mimetici -Peso gr. 250

**Taglie :** S M L XL XXL XXXL

**Applicazione :** edilizia, magazzini, tempo libero.

**Imballo minimo per ordine:** 1 pz

**Volume scatola:** 0,08 m3 - 20 pezzi - peso kg. 9

**Articolo dotato di codice a barre e confezione appendibile.**



S-XXXL

art. 461MIM

[CE-Cat.1]

(E)



Pantalone in tessuto twill di cotone 97% - elastam 3% con particolari mimetici -Peso gr. 250

**Taglie :** S M L XL XXL XXXL

**Applicazione :** edilizia, magazzini, tempo libero.

**Imballo minimo per ordine:** 1 pz

**Volume scatola:** 0,08 m3 - 20 pezzi - peso kg. 9

**Articolo dotato di codice a barre e confezione appendibile.**



S-XXXL

ABBIGLIAMENTO

art. 461MC

[CE - Cat.1]

(P/C)



Pantalone mimetico in tessuto leggero di cotone/poliestere  
 Peso gr. 190 m2  
**Taglie :** M L XL XXL XXXL  
**Applicazione :** edilizia, magazzini, tempo libero.  
**Imballo minimo per ordine:** 1 pz  
**Volume scatola:** 0,08 m3 - 20 pezzi - peso kg. 9  
**Articolo dotato di codice a barre.**



M-XXXL

art. 460GN

[CE - Cat.1]

(E)



Giubbotto in poliestere 64%, 34% cotton, 2% spandex  
 peso gr. 240 M2  
**Taglie :** M L XL XXL XXXL  
**Applicazione :** edilizia, magazzini, industria, officine.  
**Imballo minimo per ordine:** 1 paio  
**Volume scatola:** 0,10 m3 - 20 pezzi - peso kg. 7,5  
**Articolo dotato di codice a barre e confezione appendibile**



M-XXXL

## art. 461GN

## [CE - Cat.1] art. 146GN

[CE - Cat.1]

(E)



(E)



Pantalone in poliestere 64%, 34% cotton, 2% spandex  
peso gr. 240 M2 - Particolari riflettenti per la visione notturna.

**Taglie :** M L XL XXL XXXL

**Applicazione :** edilizia, magazzini, industria, officina.

**Imballo minimo per ordine:** 1 paio

**Volume scatola:** 0,10 m3 - 20 pezzi - peso kg. 7,5

**Articolo dotato di codice a barre e confezione appendibile.**

Bermuda in poliestere 64%, 34% cotton, 2% spandex -  
peso gr. 240 M2 - Particolari riflettenti per la visione notturna.

**Taglie :** M L XL XXL XXXL

**Applicazione :** edilizia, magazzini, industria, officina.

**Imballo minimo per ordine:** 1 paio

**Volume scatola:** 0,10 m3 - 20 pezzi - peso kg. 7,5

**Articolo dotato di codice a barre e confezione appendibile.**



M-XXXL



M-XXXL

art. 460BZ

[CE-Cat1]

(E)



Giacca in tessuto bicolore 65% poliestere - 32% cotone  
3% Elastam - Peso gr. 250 m<sup>2</sup>

**Taglie :** S M L XL XXL XXXL

**Applicazione :** industria, magazzini, officine.

**Imballo minimo per ordine:** 1 pz

**Volume scatola:** 0,10 m<sup>3</sup> - 20 pezzi - peso kg. 10

**Articolo dotato di codice a barre e confezione appendibile**



  
S-XXXL

art. 461BZ

[CE-Cat1]

(E)



Pantalone multitasche in tessuto bicolore 65% poliestere -  
32% cotone - 3% Elastam - Peso gr. 250 m<sup>2</sup>

**Taglie :** S M L XL XXL XXXL

**Applicazione :** industria, magazzini, officine.

**Imballo minimo per ordine:** 1 pz

**Volume scatola:** 0,10 m<sup>3</sup> - 20 pezzi - peso kg. 10

**Articolo dotato di codice a barre e confezione appendibile**



  
S-XXXL

## art. 460N

[CE - Cat.1]

## art. 461NP

[CE - Cat.1]

(P/C)



(P/C)



Giubbotto multitasche in tessuto canvas 65% poliestere - 35% cotone -  
Peso gr. 310 m2 - Sistema di areazione frontale e dorsale.

**Taglie:** M L XL XXL XXXL

**Applicazione:** industria, edilizia, magazzini.

**Imballo minimo per ordine:** 1 pz

**Volume scatola:** 0,10 m3 - 20 pezzi - peso kg. 12

Articolo dotato di codice a barre e confezione appendibile.

Pantalone multitasche in tessuto canvas 65% poliestere - 35% cotone -  
Peso gr. 310 m2 - Con sistema di areazione - Dotato di portaginnocchio.

**Taglie:** M L XL XXL XXXL

**Applicazione:** industria, edilizia, magazzini.

**Imballo minimo per ordine:** 1 pz

**Volume scatola:** 0,10 m3 - 20 pezzi - peso kg. 12

Articolo dotato di codice a barre e confezione appendibile.



M-XXXL



M-XXXL

art. 457BR

[CE - Cat. I]



Tuta intera 100% cotone - Peso gr. 245 m<sup>2</sup>

**Taglie:** S M L XL XXL XXXL

**Applicazione:** industria, magazzini, officine.

**Imballo minimo per ordine:** 1 pz

**Volume scatola:** 0,10 m<sup>3</sup> - 20 pezzi - peso kg. 10

**Articolo dotato di codice a barre e confezione appendibile**



S-XXXL

art. 458BR

[CE - Cat. I]



Pantalone con pettorina in tessuto 100% cotone.

Peso gr. 245 M<sup>2</sup>

**Taglie:** S M L XL XXL XXXL

**Applicazione:** magazzini, industria, officine.

**Imballo minimo per ordine:** 1 paio

**Volume scatola:** 0,10 m<sup>3</sup> - 20 pezzi - peso kg. 7,5

**Articolo dotato di codice a barre e confezione appendibile**



S-XXXL



## art. 460BR

## [CE - Cat.1] art. 461BR

[CE - Cat.1]

©



Giubbotto in tessuto 100% cotone - Peso gr. 245 m2

**Taglie:** S M L XL XXL XXXL

**Applicazione:** industria, magazzini, officine.

**Imballo minimo per ordine:** 1 pz

**Volume scatola:** 0,10 m3 - 20 pezzi - peso kg. 12

Articolo dotato di codice a barre e confezione appendibile.



  
S-XXXL

©



Pantalone in tessuto 100% cotone - Peso gr. 245 m2

**Taglie:** S M L XL XXL XXXL

**Applicazione:** industria, magazzini, officine.

**Imballo minimo per ordine:** 1 pz

**Volume scatola:** 0,10 m3 - 20 pezzi - peso kg. 12

Articolo dotato di codice a barre e confezione appendibile.



  
S-XXXL

art. 146BR

[CE - Cat.1]



Bermuda in tessuto 100% cotone - Peso gr. 245 m<sup>2</sup>

**Taglie :** S M L XL XXL XXXL

**Applicazione :** industria, magazzini, officine.

**Imballo minimo per ordine:** 1 pz

**Volume scatola:** 0,10 m<sup>3</sup> - 20 pezzi - peso kg. 12

**Articolo dotato di codice a barre e confezione appendibile**



M-XXXL



## art. 460NG

## [CE - Cat.1] art. 461NG

[CE - Cat.1]



M

XXL



8 011818 146448

8 011818 146479

L

XXXL



8 011818 146455

8 011818 147414

XL



8 011818 146462

S



8 011818 155662

M



8 011818 146400

L



8 011818 146417

XL



8 011818 146424

XXL



8 011818 146431

XXXL



8 011818 147407

Giubbotto bicolore con maniche asportabili in 65% poliestere / 35% cotone, peso gr. 180/m<sup>2</sup>. Dotato di porta badge

**Taglie:** M-L-XL-XXL-XXXL

**Tessuto:** poliestere/cotone

**Applicazione:** magazzini, industria, officina.

**Packing:** 1 pezzo

**Imballo minimo per ordine:** 1 pezzo

**Scatola:** 10 pezzi per taglia - volume m<sup>3</sup> 0,15 - peso kg 10

**Articolo dotato di codice a barre e confezione appendibile.**

Pantalone bicolore multitasche in 65% poliestere / 35% cotone, peso gr. 180/m<sup>2</sup>. Con tasca frontale portaginocchiera.

**Taglie:** S-M-L-XL-XXL-XXXL

**Tessuto:** poliestere/cotone

**Applicazione:** magazzini, industria, officina.

**Packing:** 1 pezzo

**Imballo minimo per ordine:** 1 pezzo

**Scatola:** 10 pezzi per taglia - volume m<sup>3</sup> 0,10 - peso kg 7

**Articolo dotato di codice a barre e confezione appendibile**



art. 459AR

[CE - Cat.1]



Giacca arancio in cotone con bottoni ricoperti elastico ai polsi

**Taglie:** 46/64

**Tessuto:** 100% cotone peso gr 250 m<sup>2</sup>

**Applicazione:** industria.

**Packing:** in busta da 1 pezzo

**Imballo minimo per ordine:** 5 pezzi per taglia e/o multipli

**Scatola:** 20 pezzi per taglia - volume m<sup>3</sup> 0,10 - peso kg 9

**Articolo dotato di codice a barre**



46 - 64

art. 460AR

[CE - Cat.1]

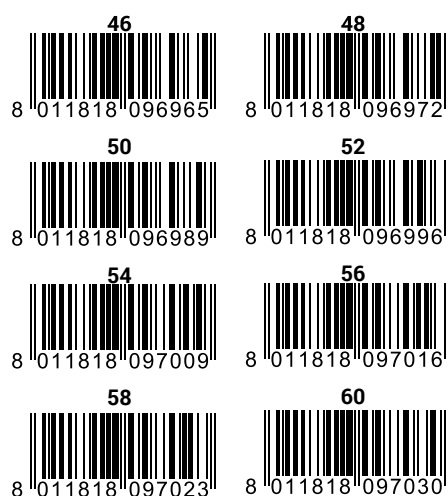

Giubbotto arancio in cotone con bottoni ricoperti

**Taglie:** 46/60

**Tessuto:** 100% cotone peso gr 250 m<sup>2</sup>

**Applicazione:** industria.

**Packing:** in busta da 1 pezzo

**Imballo minimo per ordine:** 5 pezzi per taglia e/o multipli

**Scatola:** 20 pezzi per taglia - volume m<sup>3</sup> 0,10 - peso kg 9

**Articolo dotato di codice a barre**



46 - 60

## art. 461AR

[CE - Cat.1]

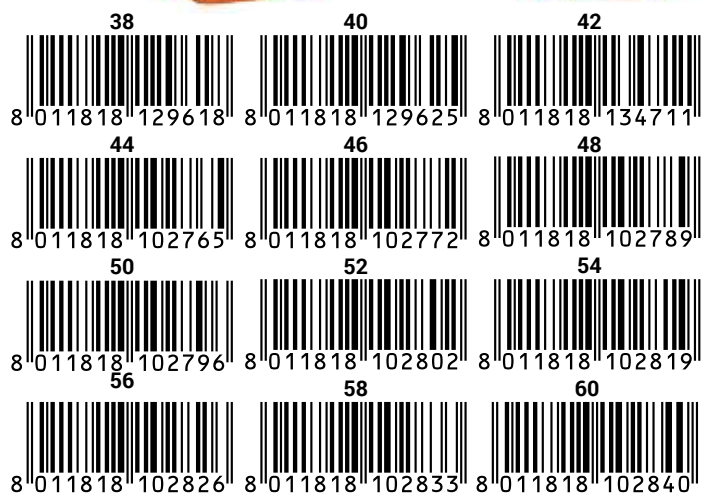

Pantaloni arancio in cotone con portametro, elastico, cordicella e passanti in vita.

**Taglie:** 38/60

**Tessuto:** 100% cotone peso gr 250 m<sup>2</sup>

**Applicazione:** industria, cantieri stradali.

**Packing:** in busta da 1 pezzo

**Imballo minimo per ordine:** 5 pezzi per taglia e/o multipli

**Scatola:** 20 pezzi per taglia - volume m<sup>3</sup> 0,10 - peso kg 9

**Articolo dotato di codice a barre**



38 - 60

## art. 460A

[CE - Cat.1]

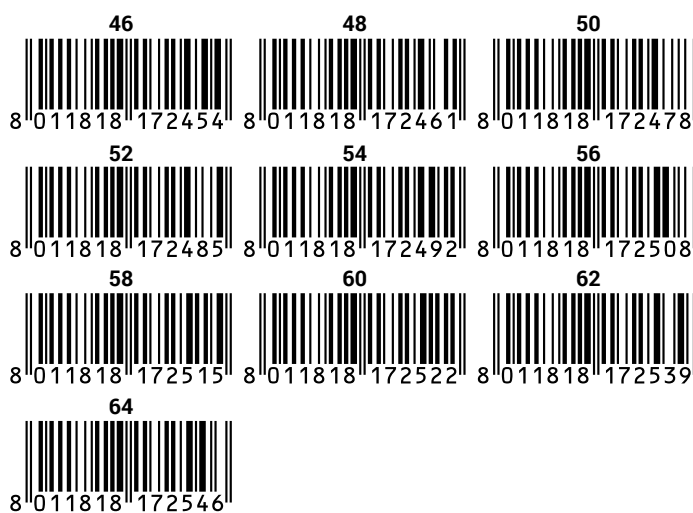

Giubbotto multitasche in cotone 35% / poliestere 65%.

Peso gr. 225 m<sup>2</sup>

**Taglie:** 46/64

**Applicazione:** industria, cantieri stradali.

**Imballo minimo per ordine:** 1 paio

**Volume scatola:** 0,10 m<sup>3</sup> - 20 pezzi - peso kg. 7,5

**Articolo dotato di codice a barre e confezione appendibile.**



46 - 64

art. 461A

[CE - Cat.1]

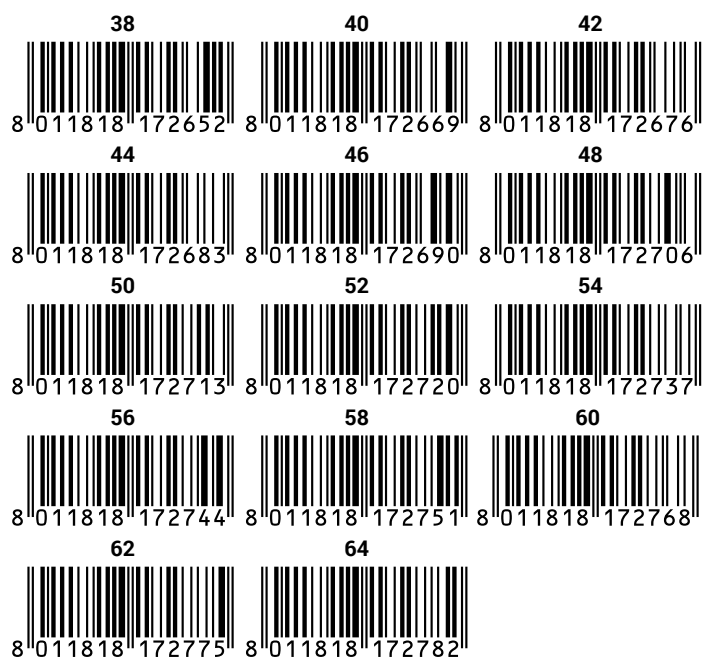

Pantalone cotone 35% / poliestere 65% - Peso gr. 225 m<sup>2</sup>  
 Elastici in vita regolabili - tasche laterali - tasche interne porta ginocchiere.  
**Taglie** : 38/64  
**Applicazione** : industria, cantieri stradali.  
**Imballo minimo per ordine** : 1 paio  
**Volume scatola** : 0,10 m<sup>3</sup> - 20 pezzi - peso kg. 7,5  
**Articolo dotato di codice a barre e confezione appendibile**



38 - 64

art. 146A

[CE - Cat.1]



Bermuda 65% cotone / 35% poliestere  
 Peso gr. 225 m<sup>2</sup>  
**Taglie** : S M L XL XXL XXXL  
**Applicazione** : industria, cantieri.  
**Imballo minimo per ordine** : 1 paio  
**Volume scatola** : 0,09 m<sup>3</sup> - 20 pezzi - peso kg. 7,5  
**Articolo dotato di codice a barre.**



S - XXXL

## art. 457G

[CE - Cat.1]

## art. 460G

[CE - Cat.1]



Tuta intera in cotone - poliestere. Elastico registrabile in vita

**Taglie:** M-L-XL-XXL-XXXL

**Tessuto:** 35% cotone 65% poliestere peso gr 225 m<sup>2</sup>

**Applicazione:** magazzini, industria, officine, edilizia.

**Packing:** in busta da 1 pezzo

**Imballo minimo per ordine:** 1 pezzo

**Scatola:** 15 pezzi per taglia - volume m<sup>3</sup> 0,10 - peso kg 9

**Articolo dotato di codice a barre**



Giubbotto 35% cotone / 65% poliestere con porta badge - gr 225 m<sup>2</sup>

**Taglie:** S-M-L-XL-XXL

**Tessuto:** poliestere/cotone

**Applicazione:** edilizia, magazzini, industria, officine.

**Packing:** in busta da 1 pezzo

**Imballo minimo per ordine:** 1 pezzo

**Scatola:** 20 pezzi per taglia - volume m<sup>3</sup> 0,12 - peso kg 8

**Articolo dotato di codice a barre e confezione appendibile.**



art. 461G

[CE - Cat.1]

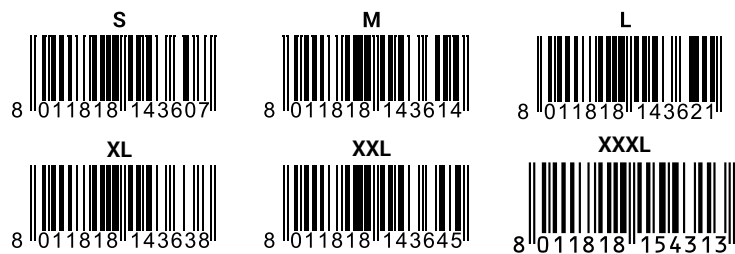

Pantaloni in 35% cotone / 65% poliestere - gr 225 m<sup>2</sup>  
**Taglie:** S-M-L-XL-XXL-XXXL  
**Tessuto:** poliestere/cotone  
**Applicazione:** edilizia, magazzini, industria, officina.  
**Packing:** in busta da 1 pezzo  
**Imballo minimo per ordine:** 5 pezzi per taglia e/o multipli  
**Scatola:** 20 pezzi per taglia - volume m<sup>3</sup> 0,15 - peso kg 10  
**Articolo dotato di codice a barre e confezione appendibile**



S-XXXL

art. 957G

[CE - Cat.1]



Gilet multitasche in 35% cotone / 65% poliestere - gr 225 m<sup>2</sup>.  
 Tasche inferiori ripiegabili all'interno  
**Taglie:** M-L-XL-XXL  
**Tessuto:** poliestere/cotone  
**Applicazione:** edilizia, magazzini, industria  
**Packing:** in busta da 1 pezzo, officina.  
**Imballo minimo per ordine:** 1 pezzo  
**Scatola:** 20 pezzi per taglia - volume m<sup>3</sup> 0,10 - peso kg 7  
**Articolo dotato di codice a barre e confezione appendibile**



M-XXL



## art. 146G

[CE - Cat.1]

## art. 457BC

[CE - Cat.1]



Bermuda in 35% cotone / 65% poliestere - gr 225 m<sup>2</sup>  
**Taglie:** S- M-L-XL-XXL  
**Tessuto:** poliestere/cotone  
**Applicazione:** edilizia, magazzini, industria, officine.  
**Packing:** in busta da 1 pezzo  
**Imballo minimo per ordine:** 1 pezzo  
**Scatola:** 20 pezzi per taglia - volume m<sup>3</sup> 0,10 - peso kg 7  
**Articolo dotato di codice a barre e confezione appendibile.**

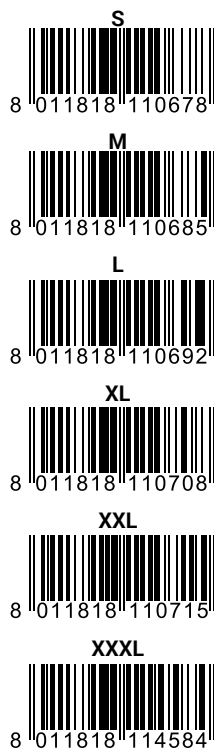

Tuta intera in cotone - poliestere. Elastico registrabile in vita  
**Taglie:** S-M-L-XL-XXL - XXXL  
**Tessuto:** 35% cotone 65% poliestere peso gr 225 m<sup>2</sup>  
**Applicazione:** magazzini, industria, officine.  
**Packing:** in busta da 1 pezzo  
**Imballo minimo per ordine:** 1 pezzo  
**Scatola:** 15 pezzi per taglia - volume m<sup>3</sup> 0,10 - peso kg 9  
**Articolo dotato di codice a barre e confezione appendibile.**



art. 460BC

[CE-Cat.1]



Giubbotto in cotone - poliestere con porta badge.  
**Taglie:** S-M-L-XL-XXL-XXXL  
**Tessuto:** 35% cotone 65% poliestere peso gr 225 m<sup>2</sup>  
**Applicazione:** industria, magazzino, officina.  
**Packing:** in busta da 1 pezzo  
**Imballo minimo per ordine:** 1 pezzo  
**Scatola:** 20 pezzi per taglia - volume m<sup>3</sup> 0,10 - peso kg 9  
**Articolo dotato di codice a barre e confezione appendibile.**



S-XXXL

art. 461BC

[CE-Cat.1]



Pantaloni in cotone - poliestere elastico registrabile in vita.  
**Taglie:** XS-S-M-L-XL-XXL-XXXL  
**Tessuto:** 35% cotone 65% poliestere peso gr 225 m<sup>2</sup>  
**Applicazione:** industria, magazzino, officina.  
**Packing:** in busta da 1 pezzo  
**Imballo minimo per ordine:** 5 pezzi  
**Scatola:** 20 pezzi per taglia - volume m<sup>3</sup> 0,10 - peso kg 9  
**Articolo dotato di codice a barre e confezione appendibile.**



XS-XXXL

art. 957BC



[CE - Cat.1]



Gilet multitasche in cotone - poliestere.  
 Tasche inferiori ripiegabili all'interno.  
**Taglie:** S-M-L-XL-XXL  
**Tessuto:** 35% cotone 65% poliestere peso gr 225 m<sup>2</sup>  
**Applicazione:** magazzini, industria, officine.  
**Packing:** in busta da 1 pezzo  
**Imballo minimo per ordine:** 1 pezzo  
**Scatola:** 20 pezzi per taglia - volume m<sup>3</sup> 0,10 - peso kg 9  
**Articolo dotato di codice a barre**

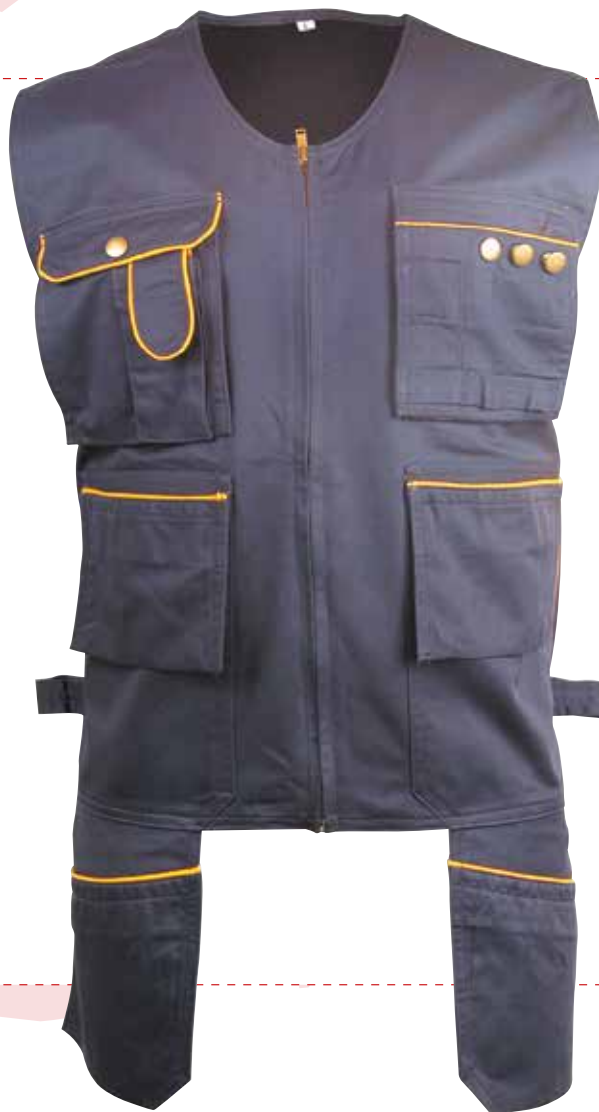

S - XXL

art. 146BC



[CE - Cat.1]



Bermuda in cotone - poliestere - elastico registrabile in vita.  
**Taglie:** S-M-L-XL-XXL  
**Tessuto:** 35% cotone 65% poliestere peso gr 225 m<sup>2</sup>  
**Applicazione:** magazzini, industria, officine.  
**Packing:** in busta da 1 pezzo  
**Imballo minimo per ordine:** 1 pezzo  
**Scatola:** 20 pezzi per taglia - volume m<sup>3</sup> 0,10 - peso kg 9  
**Articolo dotato di codice a barre**



S - XXL

art. 457VM

[CE - Cat.1]

(E)



Tuta in poliestere 65%, 32% cotton, 3% elastam  
peso gr. 270 M<sup>2</sup>

**Taglie :** S M L XL XXL

**Applicazione :** agricoltura, industria.

**Imballo minimo per ordine:** 1 paio

**Volume scatola:** 0,10 m<sup>3</sup> - 20 pezzi - peso kg. 8,5

**Articolo dotato di codice a barre e confezione appendibile.**



S-XXL

art. 458VM

[CE - Cat.1]

(E)



Salopette in poliestere 65%, 32% cotton, 3% elastam  
peso gr. 270 M<sup>2</sup>

**Taglie :** S M L XL XXL

**Applicazione :** agricoltura, industria.

**Imballo minimo per ordine:** 1 paio

**Volume scatola:** 0,10 m<sup>3</sup> - 20 pezzi - peso kg. 7,5

**Articolo dotato di codice a barre e confezione appendibile.**



S-XXL

art. 460VM

[CE - Cat.1]

(E)



S-XXXL

Giacca verde elasticizzata  
65% poliestere - 32% cotone - 3% elastam  
Peso gr.270 M<sup>2</sup>  
**Taglie :** S M L XL XXL XXXL  
**Applicazione :** industria, agricoltura/giardinaggio.  
**Imballo minimo per ordine:** 1 pz  
**Volume scatola:** 0,10 m<sup>3</sup> - 20 pezzi - peso kg. 7,5  
**Articolo dotato di codice a barre e confezione appendibile.**

art. 146VM

[CE - Cat.1]

(E)



S-XXXL

Bermuda verde elasticizzato  
65% poliestere - 32% cotone - 3% elastam  
Peso gr.270 M<sup>2</sup>  
**Taglie :** S M L XL XXL XXXL  
**Applicazione :** industria, agricoltura/giardinaggio.  
**Imballo minimo per ordine:** 1 paio  
**Volume scatola:** 0,10 m<sup>3</sup> - 20 pezzi - peso kg. 7,5  
**Articolo dotato di codice a barre e confezione appendibile..**

art. 461VM

[CE - Cat.1]

(E)



Pantalone in poliestere 65%, 32% cotton, 3% elastam  
peso gr. 270 m<sup>2</sup>

**Taglie :** S M L XL XXL XXXL

**Applicazione :** agricoltura, industria.

**Imballo minimo per ordine:** 1 paio

**Volume scatola:** 0,10 m<sup>3</sup> - 20 pezzi - peso kg. 8,5

**Articolo dotato di codice a barre e confezione appendibile.**



S-XXXL

art. 461MS

[CE - Cat.1]

(P/C)



Pantalone in poliestere/cotone.  
peso gr. 210 m<sup>2</sup>

**Taglie :** M L XL XXL XXXL

**Applicazione :** agricoltura, edilizia, magazzini.

**Imballo minimo per ordine:** 1 paio

**Volume scatola:** 0,10 m<sup>3</sup> - 20 pezzi - peso kg. 7,5

**Articolo dotato di codice a barre e confezione appendibile.**



M-XXXL

art. 957GV

[CE - Cat.1] art. 458GV

[CE - Cat.1]

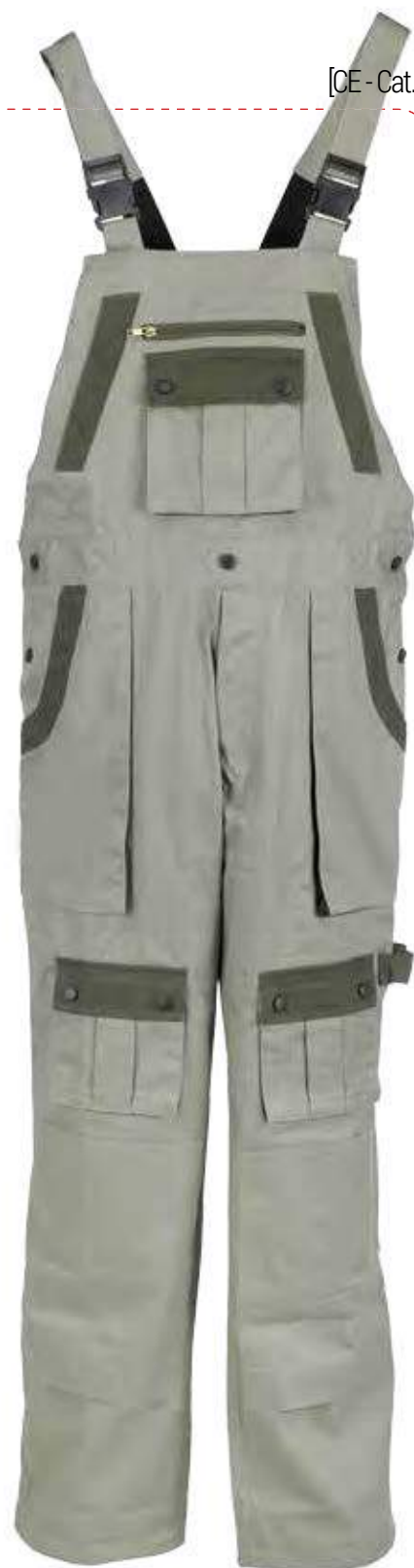

Gilet in 65% poliestere / 35% cotone, peso 180 gr/m<sup>2</sup>.

**Taglie:** M-L-XL-XXL-XXXL

**Tessuto:** poliestere/cotone

**Applicazione:** edilizia, magazzini, agricoltura.

**Packing:** in busta da 1 pezzo

**Imballo minimo per ordine:** 5 pezzi

**Scatola:** 20 pezzi per taglia - volume m<sup>3</sup> 0,10 - peso kg 7

**Articolo dotato di codice a barre e confezione appendibile.**

Pettorina in 65% poliestere / 35% cotone, peso 180 gr/m<sup>2</sup>.

**Taglie:** M-L-XL-XXL-XXXL

**Tessuto:** poliestere/cotone

**Applicazione:** edilizia, magazzini, agricoltura.

**Packing:** in busta da 1 pezzo

**Imballo minimo per ordine:** 5 pezzi

**Scatola:** 15 pezzi per taglia - volume m<sup>3</sup> 0,15 - peso kg 12

**Articolo dotato di codice a barre e confezione appendibile**



art. 460CV

[CE - Cat.1]



Giubbotto in cotone 100%. Gr. 220 m<sup>2</sup>

**Colore:** Verde

**Taglie:** S-M-L-XL-XXL-XXXL

**Applicazione:** agricoltura, giardinaggio, servizio verde pubblico.

**Imballo minimo per ordine:** 5 pezzi

**Volume scatola:** 0,10 m<sup>3</sup> (20 pezzi) Peso kg. 10

**Articolo dotato di codice a barre e confezione appendibile**



S-XXXL

art. 461CV

[CE - Cat.1]



Pantalone in cotone 100%. Gr. 220 m<sup>2</sup>

**Colore:** Verde

**Taglie:** S-M-L-XL-XXL-XXXL

**Applicazione:** agricoltura, giardinaggio, servizio verde pubblico.

**Imballo minimo per ordine:** 5 paia

**Volume scatola:** 0,10 m<sup>3</sup> (20 paia) Peso kg. 10

**Articolo dotato di codice a barre e confezione appendibile**



S-XXXL



## art. 461CVF

[CE - Cat.1]

## art. 146CV

[CE - Cat.1]



Pantalone felpato in cotone 100% - Gr. 220 m<sup>2</sup>  
**Colore:** Verde  
**Taglie:** M-L-XL-XXL-XXXL  
**Applicazione:** agricoltura, giardinaggio.  
**Imballo minimo per ordine:** 5 paia  
**Volume scatola:** 0,10 m<sup>3</sup> (20 paia) Peso kg. 11  
**Articolo dotato di codice a barre e confezione appendibile**



M-XXXL



Bermuda in cotone 100% - Gr. 220 m<sup>2</sup>  
**Colore:** Verde  
**Taglie:** S-M-L-XL-XXL-XXXL  
**Applicazione:** agricoltura, giardinaggio, servizio verde pubblico.  
**Imballo minimo per ordine:** 1 paio,  
**Volume scatola:** 0,08 m<sup>3</sup> (20 paia) Peso kg. 10  
**Articolo dotato di codice a barre e confezione appendibile**



S-XXXL

art. 455CV

[CE-Cat.1]

(C)



Camicia a manica corta in cotone 100% - Gr. 140 m<sup>2</sup>

**Colore:** Verde

**Taglie:** S-M-L-XL-XXL-XXXL

**Applicazione:** agricoltura, giardinaggio, servizio verde pubblico.

**Imballo minimo per ordine:** 1 pezzo

**Volume scatola:** 0,08 m<sup>3</sup> ( 20 pezzi ) Peso kg. 10

**Articolo dotato di codice a barre e confezione appendibile**



S-XXXL

art. 898-3V

[CE-Cat.1]

(P/C)



Felpa in cotone 35% - poliestere 65%

**Colore:** Verde

**Taglie:** S-M-L-XL-XXL-XXXL

**Applicazione:** agricoltura, giardinaggio, servizio verde pubblico.

**Imballo minimo per ordine:** 1 pezzo

**Volume scatola:** 0,08 m<sup>3</sup> ( 20 pezzi )

Peso kg. 10

**Articolo dotato di codice a barre.**



S-XXXL

art. 890

[CE - Cat.1]



Maglione verde a mezza zip in 100% acrilico con protezione ai gomiti  
**Taglie:** M-L-XL-XXL  
**Tessuto:** 100% acrilico  
**Applicazione:** agricoltura, verde pubblico.  
**Packing:** in busta da 1 pezzo  
**Imballo minimo per ordine:** 1 pezzo  
**Scatola:** 10 pezzi per taglia - volume m<sup>3</sup> 0,10 - peso kg 8  
**Articolo dotato di codice a barre**



art. 893

[CE - Cat.1]



Maglione verde a girocollo in 100% acrilico con protezione ai gomiti  
**Taglie:** M-L-XL-XXL  
**Tessuto:** 100% acrilico  
**Applicazione:** agricoltura, verde pubblico.  
**Packing:** in busta da 1 pezzo  
**Imballo minimo per ordine:** 1 pezzo  
**Scatola:** 10 pezzi per taglia - volume m<sup>3</sup> 0,10 - peso kg 8  
**Articolo dotato di codice a barre**



art. 898-3U01VE

[CE - Cat.1]

P/C



Felpa girocollo con elastico in vita, colore verde bottiglia

**Taglie:** S-M-L-XL-XXL

**Tessuto:** 50% cotone 50% poliestere

**Applicazione:** agricoltura, giardinaggio, servizio verde pubblico, tempo libero.

**Packing:** in busta da 1 pezzo

**Imballo minimo per ordine:** 1 pezzo

**Scatola:** 20 pezzi per taglia - volume m<sup>3</sup> 0,10 - peso kg 8

**Articolo dotato di codice a barre e confezione appendibile**



art. 466CV

[CE - Cat.1]

C



POLO in cotone 100% Piquet - Gr. 190 m<sup>2</sup>

**Colore:** Verde

**Taglie:** S-M-L-XL-XXL

**Applicazione:** agricoltura, giardinaggio, tempo libero. servizio verde pubblico.

**Imballo minimo per ordine:** 1 pezzo

**Volume scatola:** 0,08 m<sup>3</sup> ( 20 pezzi ) Peso kg. 10

**Articolo dotato di codice a barre e confezione appendibile**



## art. 457VE

## [CE - Cat.1] art. 458VE

[CE - Cat.1]

©



©



Tuta intera verde in cotone - c/elastico ai polsi e caviglie  
cerniera frontale ricoperta - portametro

**Taglie:** 46/60

**Tessuto:** 100% cotone peso gr 250 m<sup>2</sup>

**Applicazione:** agricoltura

**Packing:** in busta da 1 pezzo

**Imballo minimo per ordine:** 5 pezzi per taglia e/o multipli

**Scatola:** 20 pezzi per taglia - volume m<sup>3</sup> 0,10 - peso kg 12

**Articolo dotato di codice a barre e confezione appendibile.**

Salopette verde in cotone con portametro

**Taglie:** 46/60

**Tessuto:** 100% cotone peso gr 250 m<sup>2</sup>

**Applicazione:** agricoltura.

**Packing:** in busta da 1 pezzo

**Imballo minimo per ordine:** 5 pezzi per taglia e/o multipli

**Scatola:** 20 pezzi per taglia - volume m<sup>3</sup> 0,10 - peso kg 9

**Articolo dotato di codice a barre e confezione appendibile.**



46 - 60



46 - 60

art. 460VE

[CE - Cat.1]



Giubbotto verde in cotone – con bottoni ricoperti

**Taglie:** 44/62

**Tessuto:** 100% cotone peso gr 250 m<sup>2</sup>

**Applicazione:** agricoltura.

**Packing:** in busta da 1 pezzo

**Imballo minimo per ordine:** 5 pezzi per taglia e/o multipli

**Scatola:** 20 pezzi per taglia - volume m<sup>3</sup> 0,10 - peso kg 9

**Articolo dotato di codice a barre e confezione appendibile**



44 - 62

art. 461VE

[CE - Cat.1]



Pantaloni verdi in cotone con portametro elastico, cordicella e passanti in vita.

**Taglie:** 44/60

**Tessuto:** 100% cotone peso gr 250 m<sup>2</sup>

**Applicazione:** agricoltura.

**Packing:** in busta da 1 pezzo

**Imballo minimo per ordine:** 5 pezzi per taglia e/o multipli

**Scatola:** 20 pezzi per taglia - volume m<sup>3</sup> 0,10 - peso kg 9

**Articolo dotato di codice a barre e confezione appendibile**



44 - 60

art. 462VE

[CE - Cat.1]

©



Camice verde in cotone con bottoni ricoperti - elastico ai polsi  
**Taglie:** 46/60

**Tessuto:** 100% cotone peso gr 250 m<sup>2</sup>

**Applicazione:** agricoltura.

**Packing:** in busta da 1 pezzo

**Imballo minimo per ordine:** 5 pezzi per taglia e/o multipli

**Scatola:** 20 pezzi per taglia - volume m<sup>3</sup> 0,10 - peso kg 9

**Articolo dotato di codice a barre e confezione appendibile.**



46 - 60

art. 436

[CE-Cat.1] art. 440

[CE-Cat.1]



- 44  
8 011818 098181
- 46  
8 011818 098198
- 48  
8 011818 098204
- 50  
8 011818 098211
- 52  
8 011818 098228
- 54  
8 011818 098235
- 56  
8 011818 098242
- 58  
8 011818 098259
- 60  
8 011818 098266
- 62  
8 011818 098273
- 64  
8 011818 098280

- 44  
8 011818 098792
- 46  
8 011818 098808
- 48  
8 011818 098815
- 50  
8 011818 098822
- 52  
8 011818 098839
- 54  
8 011818 098846
- 56  
8 011818 098853
- 58  
8 011818 098860
- 60  
8 011818 098877
- 62  
8 011818 098884

Tuta intera blu in cotone con elastico ai polsi e caviglie - cerniera frontale ricoperta - portametro

**Taglie:** 44/64

**Tessuto:** 100% cotone peso gr 250 m<sup>2</sup>

**Applicazione:** industria, edilizia.

**Packing:** in busta da 1 pezzo

**Imballo minimo per ordine:** 5 pezzi per taglia e/o multipli

**Scatola:** 20 pezzi per taglia - volume m<sup>3</sup> 0,10 - peso kg 12

**Articolo dotato di codice a barre e confezione appendibile.**

Salopette blu in cotone con portametro

**Taglie:** 44/62

**Tessuto:** 100% cotone peso gr 250 m<sup>2</sup>

**Applicazione:** industria, edilizia.

**Packing:** in busta da 1 pezzo

**Imballo minimo per ordine:** 5 pezzi per taglia e/o multipli

**Scatola:** 20 pezzi per taglia - volume m<sup>3</sup> 0,10 - peso kg 9

**Articolo dotato di codice a barre e confezione appendibile.**





## art. 437A

[CE - Cat.1]

## art. 437AF

[CE - Cat.1]



Giubbotto blu in cotone c/bottoni ricoperti

**Taglie:** 44/62

**Tessuto:** 100% cotone peso gr 250 m<sup>2</sup>

**Applicazione:** industria, edilizia.

**Packing in busta da 1 pezzo**

**Imballo minimo per ordine:** 5 pezzi per taglia e/o multipli

**Scatola:** 20 pezzi per taglia - volume m<sup>3</sup> 0,10 - peso kg 9

**Articolo dotato di codice a barre e confezione appendibile**



Giubbotto in fustagno blu

**Taglie:** M-L-XL-XXL

**Tessuto:** 100% cotone fustagno peso gr 350 m<sup>2</sup>

**Applicazione:** industria, edilizia.

**Packing:** in busta da 1 pezzo

**Imballo minimo per ordine:** 5 pezzi per taglia e/o multipli

**Scatola:** 20 pezzi per taglia - volume m<sup>3</sup> 0,10 - peso kg 10

**Articolo dotato di codice a barre e confezione appendibile**



art. 438 ©



[CE-Cat.1]

art. 461R

[CE-Cat.1]



38 8 011818 130799		
40 8 011818 096507		
42 8 011818 096491		
44 8 011818 096514		
46 8 011818 096521		
48 8 011818 096538		
50 8 011818 096545		
52 8 011818 096552	54 8 011818 096569	56 8 011818 096576
58 8 011818 096583	60 8 011818 096590	62 8 011818 090741

Pantaloni blu in cotone c/portametro - elastico, cordicella e passanti in vita

**Taglie:** 38/62 - **Tessuto:** 100% cotone peso gr 250 m<sup>2</sup>

**Applicazione:** edilizia, industria. **Packing:** in busta da 1 pezzo

**Imballo minimo per ordine:** 5 pezzi per taglia e/o multipli

**Scatola:** 20 pezzi per taglia - volume m<sup>3</sup> 0,10 - peso kg 9

Articolo dotato di codice a barre e confezione appendibile.

art. 438F © ❄️

M 8 011818 099331	L 8 011818 099348	XL 8 011818 099355
XXL 8 011818 099362	XXXL 8 011818 132427	

Pantaloni blu in fustagno

**Taglie:** M-L-XL-XXL-XXXL - **Tessuto:** 100% cotone fustagno peso gr 350 m<sup>2</sup>

**Applicazione:** edilizia, industria. **Packing:** in busta da 1 pezzo

**Imballo minimo per ordine:** 5 pezzi per taglia e/o multipli

**Scatola:** 20 pezzi per taglia - volume m<sup>3</sup> 0,10 - peso kg 10

Articolo dotato di codice a barre e confezione appendibile.

S 8 011818 120554	M 8 011818 111491	L 8 011818 111507
XL 8 011818 111514	XXL 8 011818 111521	XXXL 8 011818 1115819

Pantaloni blu multitasche.

**Taglie:** S-M-L-XL-XXL-XXXL

**Tessuto:** 100% cotone peso gr 240 m<sup>2</sup>

**Applicazione:** edilizia, industria.

**Packing:** in busta da 1 pezzo

**Imballo minimo per ordine:** 5 pezzi per taglia e/o multipli

**Scatola:** 20 pezzi per taglia - volume m<sup>3</sup> 0,10 - peso kg 10

Articolo dotato di codice a barre e confezione appendibile.



art. 438



38 - 62

art. 438F



M-XXXL



S-XXXL

## art. 439

[CE - Cat.1]



**250 gr - m<sup>2</sup>**

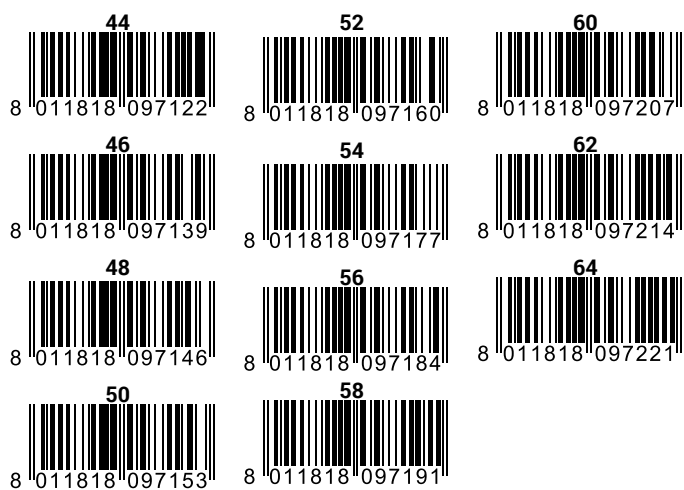

Camice blu in cotone - elastico ai polsi - bottoni ricoperti.

**Taglie:** 44/64

**Tessuto:** 100% cotone peso gr 250 m<sup>2</sup>

**Applicazione:** industria.

**Packing:** in busta da 1 pezzo

**Imballo minimo per ordine:** 5 pezzi per taglia e/o multipli

**Scatola:** 20 pezzi per taglia - volume m<sup>3</sup> 0,10 - peso kg 9

**Articolo dotato di codice a barre e confezione appendibile**



**44 - 64**

## art. 462BL

[CE - Cat.1]



**140 gr - m<sup>2</sup>**



Versione in cotone leggero da gr. 140 m<sup>2</sup>

**Taglie:** 46-62

**Articolo dotato di codice a barre e confezione appendibile**



**46 - 62**



## art. 462MTBD

P/C



Camice da donna in 65% poliestere 35% cotone, peso 140 gr/m<sup>2</sup>

**Taglie:** 38/44

**Tessuto:** poliestere/cotone

**Applicazione:** edilizia, magazzini, industria, imprese di pulizie

**Packing:** in busta da 1 pezzo

**Imballo minimo per ordine:** 5 pezzi per taglia e/o multipli

**Scatola:** 20 pezzi per taglia - volume m<sup>3</sup> 0,10 - peso kg 8

**Articolo dotato di codice a barre e confezione appendibile**



[CE - Cat.1]



38 - 44

## art. 462MTC

P/C



Camice da donna a manica corta in 65% poliestere / 35% cotone, peso 140 gr/m<sup>2</sup>

**Taglie:** 38/42

**Tessuto:** poliestere/cotone

**Applicazione:** edilizia, magazzini, industria, imprese di pulizie

**Packing:** in busta da 1 pezzo

**Imballo minimo per ordine:** 5 pezzi per taglia e/o multipli

**Scatola:** 20 pezzi per taglia - volume m<sup>3</sup> 0,10 - peso kg 8

**Articolo dotato di codice a barre e confezione appendibile**



[CE - Cat.1]



38 - 42

art. 015

[CE - Cat.1]



8 011818 102659



Parannanza in cotone gr 240 m<sup>2</sup>

**Taglia:** unica

**Tessuto:** 100% cotone

**Applicazione:** , industria.

**Packing:** in busta da 1 pezzo

**Imballo minimo per ordine:** 1 pezzo

**Scatola:** 20 pezzi per taglia - volume m<sup>3</sup> 0,10 - peso kg 7

**Articolo dotato di codice a barre.**



UNICA

art. 462BLD

[CE - Cat.1]

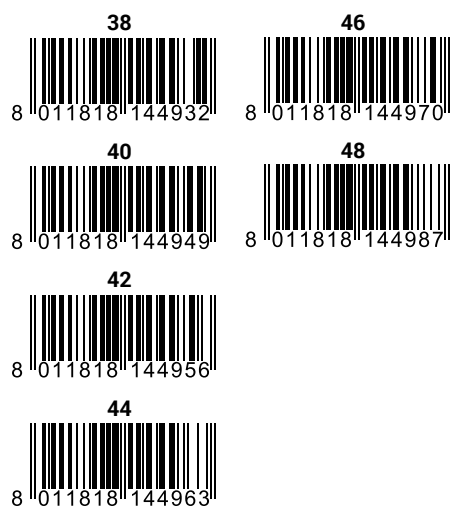

38  
8 011818 144932

46  
8 011818 144970

40  
8 011818 144949

48  
8 011818 144987

42  
8 011818 144956

44  
8 011818 144963



Camice da donna in 65% poliestere / 35% cotone,  
peso gr.140/m<sup>2</sup>.

**Taglie:** 38/48

**Tessuto:** poliestere/cotone

**Applicazione:** industria, imprese di pulizie.

**Packing:** in busta da 1 pezzo

**Imballo minimo per ordine:** 5 pezzi per taglia e/o multipli

**Scatola:** 20 pezzi per taglia - volume m<sup>3</sup> 0,12 - peso kg 10

**Articolo dotato di codice a barre e confezione appendibile.**



38 - 48

art. 461M

[CE - Cat.1]

art. 146M

[CE - Cat.1]



CANVAS



S



8 011818 146486

M



8 011818 146493

L



8 011818 146509

XL



8 011818 146516

XXL



8 011818 146523

XXXL



8 011818 147315

Pantalone bicolore multitasche in tessuto canvas di cotone gr.300/m<sup>2</sup> con inserti in cordura®, tasche frontali portaginocchiera.

Elastico in vita regolabile

**Taglie:** S- M-L-XL-XXL-XXXL

**Tessuto:** cotone canvas/cordura®

**Applicazione:** edilizia, magazzini

**Packing:** 1 pezzo

**Imballo minimo per ordine:** 1 pezzo

**Scatola:** 10 pezzi per taglia - volume m<sup>3</sup> 0,10 - peso kg 7

Articolo dotato di codice a barre e confezione appendibile



S-XXXL



CANVAS



S



8 011818 146530

M



8 011818 146547

L



8 011818 146554

XL



8 011818 146561

XXL



8 011818 146578

XXXL



8 011818 147322

Bermuda multitasche in tessuto canvas di cotone gr.300/m<sup>2</sup>.

Elastico in vita regolabile.

**Taglie:** S-M-L-XL-XXL-XXXL

**Tessuto:** cotone canvas

**Applicazione:** edilizia, magazzini

**Packing:** 1 pezzo

**Imballo minimo per ordine:** 1 pezzo

**Scatola:** 10 pezzi per taglia - volume m<sup>3</sup> 0,10 - peso kg 7

Articolo dotato di codice a barre e confezione appendibile



S-XXXL

art. 461CAN

[CE-Cat.1] art. 461RIF

[CE-Cat.1]

©



©



Pantalone 100% cotone canvas – Peso gr. 270 m<sup>2</sup>

**Taglie :** M L XL XXL XXXL

**Applicazione :** industria, cantieri e lavori edili, magazzini.

**Imballo minimo per ordine:** 1 paio

**Volume scatola:** 0,10 m<sup>3</sup> - 20 pezzi - peso kg. 9

**Articolo dotato di codice a barre e confezione appendibile.**





## art. 461LBC

[CE - Cat.1]

(P/C)

180 gr m<sup>2</sup>



S

M

L



8 011818 170467 8 011818 170474 8 011818 170481

XL

XXL

XXXL



8 011818 170498 8 011818 170504 8 011818 170511

Pantalone in poliestere 65%, cotone 35%  
Peso gr. 180 m<sup>2</sup> - Elastico regolabile in vita.

**Taglie:** S M L XL XXL XXXL

**Applicazione:** edilizia, magazzini, industria.

**Imballo minimo per ordine:** 1 paio

**Volume scatola:** 0,10 m<sup>3</sup> - 20 pezzi - peso kg. 7,5

Articolo dotato di codice a barre e confezione appendibile.



S-XXXL

## art. 461RF

[CE - Cat.1]

(P/C)



M

L

XL



8 011818 172997 8 011818 173000 8 011818 173017

XXL

XXXL



8 011818 173024 8 011818 173031

Pantalone in poliestere 65%, cotone 35% - Peso gr. 240 m<sup>2</sup> -  
Bande riflettenti per la visione notturna.

**Taglie:** M L XL XXL XXXL

**Applicazione:** edilizia, magazzini, industria.

**Imballo minimo per ordine:** 1 paio

**Volume scatola:** 0,10 m<sup>3</sup> - 20 pezzi - peso kg. 7,5

Articolo dotato di codice a barre e confezione appendibile.



M-XXXL

art. 456CA

[CE - Cat.1] art. 456E

[CE - Cat.1]

(C)



(E)

JEANS



Camicia in jeans stone washed

**Taglie:** M-L-XL-XXL

**Tessuto:** jeans di cotone

**Applicazione:** industria, edilizia, tempo libero.

**Packing:** in busta da 1 pezzo

**Imballo minimo per ordine:** 5 pezzi per taglia e/o multipli

**Scatola:** 20 pezzi per taglia - volume m<sup>3</sup> 0,08 - peso kg 8

**Articolo dotato di codice a barre e confezione appendibile.**



M-XXL



Pantalone Jeans elasticizzato stoned washed - Peso 12,5 once.

**Taglie :** M L XL XXL

**Applicazione :** edilizia, magazzini, industria.

**Imballo minimo per ordine:** 1 paio

**Volume scatola:** 0,10 m<sup>3</sup> - 20 pezzi - peso kg. 7,5

**Articolo dotato di codice a barre e confezione appendibile.**



M-XXL

art. 456

[CE - Cat.1]

**C**  
JEANS



44  8 011818 132960	46  8 011818 121230	48  8 011818 121247
50  8 011818 121261	52  8 011818 121278	54  8 011818 121292
56  8 011818 121308	58  8 011818 121315	60  8 011818 121322
62  8 011818 149463	64  8 011818 149470	

Pantaloni in jeans. Stone washed

**Taglie:** dal 44 a 60 - **Tessuto:** jeans di cotone peso oz 12,5

**Applicazione:** industria, edilizia, tempo libero.

**Packing:** in busta da 1 pezzo

**Imballo minimo per ordine:** 5 pezzi per taglia e/o multipli

**Scatola:** 20 pezzi per taglia - volume m<sup>3</sup> 0,08 - peso kg 9

**Articolo dotato di codice a barre.**



44 - 64

art. 455AR

[CE - Cat.1]



MANICA  
CORTA



8 011818 099591



8 011818 099607



8 011818 099614



8 011818 099621

Camicia arancio 100% cotone con manica corta

**Taglie:** M-L-XL-XXL

**Tessuto:** 100% cotone peso gr 140 m<sup>2</sup>

**Applicazione:** edilizia, industria.

**Packing:** in busta da 1 pezzo

**Imballo minimo per ordine:** 5 pezzi per taglia e/o multipli

**Scatola:** 20 pezzi per taglia - volume m<sup>3</sup> 0,10 - peso kg 8

**Articolo dotato di codice a barre e confezione appendibile.**



M-XXL

art. 456AR

[CE - Cat.1]



MANICA  
LUNGA



8 011818 099713



8 011818 099720



8 011818 099737



8 011818 099744

Camicia arancio 100% cotone con manica lunga

**Taglie:** M-L-XL-XXL

**Tessuto:** 100% cotone peso gr 140 m<sup>2</sup>

**Applicazione:** edilizia, industria.

**Packing:** in busta da 1 pezzo

**Imballo minimo per ordine:** 5 pezzi per taglia e/o multipli

**Scatola:** 20 pezzi per taglia - volume m<sup>3</sup> 0,10 - peso kg 8

**Articolo dotato di codice a barre e confezione appendibile.**



M-XXL

## art. 456AZ

[CE - Cat.1]



8 011818 145649



8 011818 145656



8 011818 145663



8 011818 145670

Camicia azzurra a manica lunga in poliestere/cotone,  
peso gr. 130/m<sup>2</sup>

**Taglie:** M-L-XL-XXL

**Tessuto:** poliestere/cotone

**Applicazione:** industria, ufficio, tempo libero.

**Packing:** in busta da 1 pezzo

**Imballo minimo per ordine:** 5 pezzi per taglia e/o multipli

**Scatola:** 20 pezzi per taglia - volume m<sup>3</sup> 0,10 - peso kg 8

**Articolo dotato di codice a barre e confezione appendibile.**



M-XXL

## art. 456BI

[CE - Cat.1]



8 011818 145724



8 011818 145731



8 011818 145748



8 011818 145755

Camicia bianca a manica lunga in poliestere/cotone,  
Peso gr. 130/m<sup>2</sup>

**Taglie:** M-L-XL-XXL

**Tessuto:** poliestere/cotone

**Applicazione:** ufficio, tempo libero.

**Packing:** in busta da 1 pezzo

**Imballo minimo per ordine:** 5 pezzi per taglia e/o multipli

**Scatola:** 20 pezzi per taglia - volume m<sup>3</sup> 0,10 - peso kg 8

**Articolo dotato di codice a barre e confezione appendibile.**



M-XXL

art. 456GR

[CE - Cat.1]



Camicia grigia a manica lunga in cotone oxford,  
peso gr. 140/m<sup>2</sup>

**Taglie:** M-L-XL-XXL

**Tessuto:** cotone

**Applicazione:** industria, ufficio, tempo libero.

**Packing:** in busta da 1 pezzo

**Imballo minimo per ordine:** 5 pezzi per taglia e/o multipli

**Scatola:** 10 pezzi per taglia - volume m<sup>3</sup> 0,10 - peso kg 8

**Articolo dotato di codice a barre e confezione appendibile.**



art. 456OX

[CE - Cat.1]



Camicia 100% cotone oxford con manica lunga.

Peso gr 140 m<sup>2</sup>

**Taglie:** S-M-L-XL-XXL

**Tessuto:** 100% cotone peso gr 140 m<sup>2</sup>

**Applicazione:** industria, edilizia, tempo libero.

**Packing:** in busta da 1 pezzo

**Imballo minimo per ordine:** 5 pezzi per taglia e/o multipli

**Scatola:** 20 pezzi per taglia - volume m<sup>3</sup> 0,10 - peso kg 8

**Articolo dotato di codice a barre e confezione appendibile.**



## art. 455CI

[CE - Cat.1]



Camicia blu 100% cotone con manica corta

**Taglie:** M-L-XL-XXL

**Tessuto:** 100% cotone peso gr 140 m<sup>2</sup>

**Applicazione:** industria, edilizia.

**Packing:** in busta da 1 pezzo

**Imballo minimo per ordine:** 5 pezzi per taglia e/o multipli

**Scatola:** 20 pezzi per taglia - volume m<sup>3</sup> 0,10 - peso kg 8

**Articolo dotato di codice a barre**



M-XXL

## art. 456CI

[CE - Cat.1]



Camicia blu 100% cotone con manica lunga

**Taglie:** M-L-XL-XXL

**Tessuto:** 100% cotone peso gr 140 m<sup>2</sup>

**Applicazione:** industria, edilizia.

**Packing:** in busta da 1 pezzo

**Imballo minimo per ordine:** 5 pezzi per taglia e/o multipli

**Scatola:** 20 pezzi per taglia - volume m<sup>3</sup> 0,10 - peso kg 8

**Articolo dotato di codice a barre**



M-XXL

art.6-G1



Ginocchiera in EVA  
**Applicazione:** industria, edilizia.  
**Imballo minimo per ordine:** 10 paia  
**Volume scatola:** 0,03 m<sup>3</sup> ( 10 pezzi ) - Peso: Kg 1

art. 6-BR3



Bretella elasticizzata  
**Imballo minimo per ordine:** 10 pz  
**Volume scatola:** 0,03 m<sup>3</sup> ( 10 pezzi ) -  
 Peso: Kg 1

art. 115



Porta badge amovibile in PVC





# ALTA VISIBILITÀ



## art. 950AN

[EN20471]

CE



M



8 011818 174281

L



8 011818 174298

XL



8 011818 174304

XXL



8 011818 174311

XXXL



8 011818 174328

Giubbotto imbottito invernale alta visibilità arancio/nero con bande riflettenti - Maniche staccabili - Cappuccio estraibile

**Taglie:** M L XL XXL XXXL

**Tessuto:** NYLON/PVC

**Applicazione:** industria, edilizia, cantieri stradali.

**Imballo minimo per ordine:** 1 pezzo.

**Volume scatola:** 0,10 m3 - 10 pezzi - peso kg. 10

**Articolo dotato di codice a barre.**



M-XXXL

## art. 950P

[EN20471]

CE



M



8 011818 174397

L



8 011818 174403

XL



8 011818 174410

XXL



8 011818 174427

XXXL



8 011818 174434

Pantalone imbottito invernale alta visibilità arancio/nero con bande riflettenti

**Taglie:** M L XL XXL XXXL

**Tessuto:** NYLON/PVC

**Applicazione:** industria, edilizia, cantieri stradali.

**Imballo minimo per ordine:** 10 paia.

**Volume scatola:** 0,10 m3 - 10 pezzi - peso kg. 10

**Articolo dotato di codice a barre.**



M-XXXL

## art. 950AVGI

[EN 20471]

CE

3



Giubbotto imbottito ad alta visibilità, impermeabile, con maniche asportabili e cappuccio estraibile. Bande riflettenti.

COLORE GIALLO

**Taglie:** S-M-L-XL-XXL-XXXL

**Tessuto:** nylon/PVC

**Imbottitura:** 100% poliestere con fodera in nylon taffeta

**Applicazione:** edilizia, lavorazioni stradali, industria.

**Packing:** in busta da 1 pezzo

**Imballo minimo per ordine:** 1 pezzo

**Scatola:** 10 pezzi per taglia - volume m<sup>3</sup> 0,15 - peso kg 12

**Articolo dotato di codice a barre**



S-XXXL

## art. 950AV

[EN 20471]

CE

3

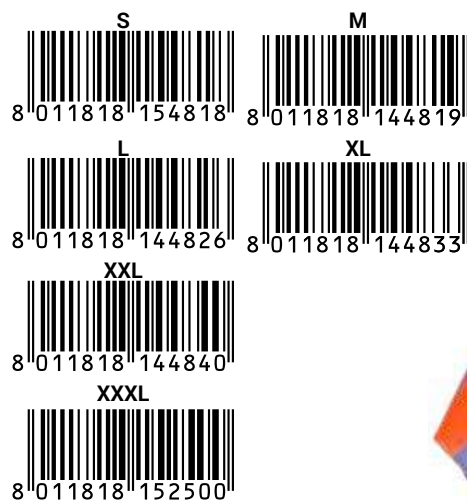

Giubbotto imbottito ad alta visibilità, impermeabile, con maniche asportabili e cappuccio estraibile. Bande riflettenti. COLORE ARANCIO

**Taglie:** S-M-L-XL-XXL-XXXL

**Tessuto:** nylon/PVC

**Imbottitura:** 100% poliestere con fodera in nylon taffeta

**Applicazione:** edilizia, lavorazioni stradali, industria.

**Packing:** in busta da 1 pezzo

**Imballo minimo per ordine:** 1 pezzo

**Scatola:** 10 pezzi per taglia - volume m<sup>3</sup> 0,15 - peso kg 12

**Articolo dotato di codice a barre**



S-XXXL

● art. 109R

● art. 109RG

art. 464AR

[CE-Cat.1]



Bretelle arancio o giallo ad alta visibilità

**Taglia:** UNICA

**Tessuto:** poliestere

**Applicazione:** tempo libero

**Packing:** in busta da 1 pezzo

**Imballo minimo per ordine:** 1 pezzo.

**Scatola:** 100 pezzi - volume m<sup>3</sup> 0,14

- peso kg 10

Articolo dotato di codice a barre



UNICA



T-shirt in colore arancio - collo largo, doppio a 4 rib

**Taglie:** S-M-L-XL-XXL

**Tessuto:** 100% cotone peso gr 120 m<sup>2</sup>

**Applicazione:** edilizia

**Packing:** in buste da 12 pezzi ripiegate in due.

**Imballo minimo per ordine:** 12 pezzi per taglia e/o multipli

**Scatola:** 120 pezzi per taglia - volume m<sup>3</sup> 0,10 - peso kg 14

Articolo dotato di codice a barre



S-XXL

art. 898AV

[EN 20471]



Pile ad alta visibilità con 1/2 zip.

**Taglie:** S-M-L-XL-XXL-XXXL

**Imbottitura:** 100% poliestere

**Applicazione:** edilizia, industria, cantieri stradali.

**Packing:** in busta da 1 pezzo

**Imballo minimo per ordine:** 1 pezzo

**Scatola:** 20 pezzi per taglia volume m<sup>3</sup> 0,10 - peso kg 9

Articolo dotato di codice a barre



S-XXXL

## ● art. 109FE ● art. 109FG

[EN 20471]



2



ARANCIO



8 011818 101362

CON PORTA BADGE

GIALLO



8 011818 101386

SENZA PORTA BADGE



Gilet ad alta visibilità

**Taglia:** UNICA

**Tessuto:** 100% poliestere

**Applicazione:** edilizia, industria, cantieri

**Packing:** in busta da 1 pezzo

**Imballo minimo per ordine:** 30 pezzi e/o multipli

**Scatola:** 30 pezzi - volume m<sup>3</sup> 0,08 - peso kg 7

**Resistente a 25 lavaggi.**

**Articolo dotato di codice a barre**



UNICA

## art. 132AV-SH

[EN 20471]



2



S



8 011818 174762

M



8 032668 100817

L



8 032668 100800

XL



8 032668 100824

XXL



8 032668 101203

XXXL



8 011818 174779



Polo arancio ad alta visibilità con bande riflettenti

**Taglie:** S-M-L-XL-XXL - XXXL

**Tessuto:** 100% poliestere peso gr 130 m<sup>2</sup>

**Applicazione:** edilizia, industria, cantieri stradali.

**Packing:** in busta da 1 pezzo

**Imballo minimo per ordine:** 1 pezzo

**Scatola:** 20 pezzi per taglia - volume m<sup>3</sup> 0,08 - peso kg 8

**Articolo dotato di codice a barre**



S-XXXL

## art. 100F

[EN 20471]



3



Giacca invernale impermeabile in Nylon/PVC con cappuccio. Interno trapuntato.

**Taglie:** S-M-L-XL-XXL-XXXL

**Imbottitura:** 100% poliestere

**Applicazione:** edilizia, cantieri, industria.

**Packing:** in busta da 1 pezzo

**Imballo minimo per ordine:** 1 pezzo

**Scatola:** 10 pezzi per taglia - volume m3 0,10  
- peso kg 7

**Articolo dotato di codice a barre.**



S-XXXL

## art. 100FSE

[EN 20471]



3

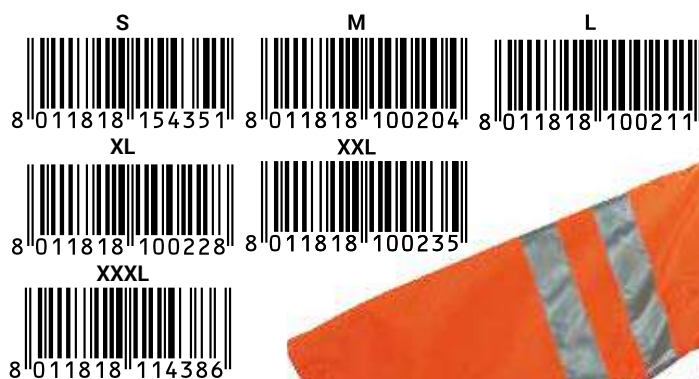

Giacca arancio impermeabile ad alta visibilità con porta badge.

Triplo uso. Parte interna imbottita - maniche staccabili.

Con cappuccio interno.

**Taglie:** S-M-L-XL-XXL-XXXL

**Tessuto esterno:** nylon spalmato in PVC con cuciture termosaldate

**Interno:** corpetto ad alta visibilità in nylon/pvc c/maniche blu trapuntate.

**Imbottitura:** 100% poliestere

**Applicazione:** edilizia, industria, cantieri.

**Packing:** in busta da 1 pezzo

**Imballo minimo per ordine:** 1 pezzo

**Scatola:** 10 pezzi per taglia - volume m³ 0,15 - peso kg 12

**Articolo dotato di codice a barre**



S-XXXL

## art. 100FSB

[EN 20471]

CE

3



Giacca bicolore blu/arancio ad alta visibilità impermeabile e traspirante. Triplo uso, con cappuccio estraibile. Parte interna imbottita - maniche staccabili.

**Taglie:** M-L-XL-XXL

**Tessuto esterno:** Poliestere traspirante con cuciture termosaldate

**Interno:** giacca arancio bicolore blu/arancio in poliestere traspirante c/maniche staccabili

**Imbottitura:** 100% poliestere

**Applicazione:** edilizia, industria, cantieri stradali.

**Packing:** in busta da 1 pezzo

**Imballo minimo per ordine:** 1 pezzo

**Scatola:** 10 pezzi per taglia - volume m<sup>3</sup> 0,15 - peso kg 12

**Articolo dotato di codice a barre**



M-XXL

## art. 100FBG

[EN 20471]

CE

3



Giacca imbottita impermeabile ad alta visibilità giallo/blue. Cerniere YKK

**Taglie:** M-L-XL-XXL

**Tessuto:** 300D OXFORD spalmato PU

**Applicazione:** edilizia, industria, cantieri stradali.

**Fodera:** 100% nylon 190T

**Imbottitura:** 100% poliestere - peso gr. 180 m<sup>2</sup>

**Cerniere YKK**

**Packing:** in busta da 1 pezzo

**Imballo minimo per ordine:** 1 pezzo

**Scatola:** 10 pezzi per taglia - volume m<sup>3</sup> 0,10 - peso kg 8

**Articolo dotato di codice a barre**



M-XXL



art. 382

[EN 20471]



8 011818 122077



8 011818 100372



8 011818 100396



8 011818 100365



8 011818 100389

Tuta intera arancio ad alta visibilità

**Taglie:** S-M-L-XL-XXL

**Tessuto:** 60% cotone 40% poliestere peso gr 270 m<sup>2</sup>

**Applicazione:** edilizia, industria, cantieri.

**Packing:** in busta da 1 pezzo

**Imballo minimo per ordine:** 1 pezzo

**Scatola:** 20 pezzi per taglia - volume m<sup>3</sup> 0,10 - peso kg 10

**Articolo dotato di codice a barre**



S-XXL

art. 382G

[EN 20471]



8 011818 112832



8 011818 112856



8 011818 112849



8 011818 112863

Tuta intera colore giallo ad alta visibilità

**Taglie:** S-M-L-XL-XXL

**Tessuto:** 60% cotone 40% poliestere peso gr 270 m<sup>2</sup>

**Applicazione:** edilizia, industria, cantieri.

**Packing:** in busta da 1 pezzo

**Imballo minimo per ordine:** 1 pezzo

**Scatola:** 20 pezzi per taglia - volume m<sup>3</sup> 0,10 - peso kg 10

**Articolo dotato di codice a barre**



M-XXL

art. 382BA

[EN 20471]



8 011818 143447



8 011818 131017



8 011818 143454



8 011818 143461

Tuta intera alta visibilità bicolore 60%cotone 40% poliestere, peso gr 270 m<sup>2</sup>

**Taglie:** M-L-XL-XXL - **Tessuto:** cotone/poliestere

**Applicazione:** edilizia, industria, cantieri.

**Packing:** in busta da 1 pezzo

**Imballo minimo per ordine:** 1 pezzo

**Scatola:** 20 pezzi per taglia - volume m<sup>3</sup> 0,12 - peso kg 10

**Articolo dotato di codice a barre**



M-XXL

art. 382F

[EN 20471]



8 011818 113600



8 011818 113624



8 011818 113617



8 011818 113679

Tuta intera arancio alta visibilità felpata internamente

**Taglie:** M-L-XL-XXL - **Tessuto:** Fustagno 60% cotone

40% poliestere peso gr 320 m<sup>2</sup> - Applicazione: edilizia,

industria, cantieri. **Packing:** in busta da 1 pezzo

**Imballo minimo per ordine:** 1 pezzo

**Scatola:** 20 pezzi per taglia - volume m<sup>3</sup> 0,10 - peso kg 12

**Articolo dotato di codice a barre**



M-XXL





## art. 383

[EN 20471]



Pantalone con pettorina arancio ad alta visibilità

**Taglie:** M-L-XL-XXL-XXXL

**Tessuto:** 60% cotone 40% poliestere peso gr 270 m<sup>2</sup>

**Applicazione:** edilizia, industria, cantieri stradali.

**Packing:** in busta da 1 pezzo

**Imballo minimo per ordine:** 1 pezzo

**Scatola:** 20 pezzi per taglia - volume m<sup>3</sup> 0,10 - peso kg 9

Articolo dotato di codice a barre



M-XXXL

## art. 383G

[EN 20471]



Pantalone con pettorina giallo ad alta visibilità

**Taglie:** M-L-XL-XXL

**Tessuto:** 60% cotone 40% poliestere peso gr 270 m<sup>2</sup>

**Applicazione:** edilizia, industria, cantieri stradali.

**Packing:** in busta da 1 pezzo

**Imballo minimo per ordine:** 1 pezzo

**Scatola:** 20 pezzi per taglia - volume m<sup>3</sup> 0,10 - peso kg 9

Articolo dotato di codice a barre



M-XXL

## art. 383BA

[EN 20471]

Pettorina alta visibilità bicolore 60%cotone 40% poliestere, peso gr 270 m<sup>2</sup>

**Taglie:** M-L-XL-XXL-XXXL

**Tessuto:** cotone/poliestere

**Applicazione:** edilizia, industria, cantieri stradali.

**Packing:** in busta da 1 pezzo

**Imballo minimo per ordine:** 1 pezzo

**Scatola:** 20 pezzi per taglia - volume m<sup>3</sup> 0,12 - peso kg 10

Articolo dotato di codice a barre



M-XXXL



art. 384BA

[EN 20471]



Giubbotto alta visibilità bicolore 60%cotone 40% poliestere, peso gr 270 m<sup>2</sup>  
**Taglie:** M-L-XL-XXL  
**Tessuto:** cotone/poliestere  
**Applicazione:** edilizia, industria, cantieri stradali.  
**Packing:** in busta da 1 pezzo  
**Imballo minimo per ordine:** 1 pezzo  
**Scatola:** 20 pezzi per taglia - volume m<sup>3</sup> 0,12 - peso kg 10  
**Articolo dotato di codice a barre**



art. 384G

[EN 20471]



Giubbotto giallo ad alta visibilità  
**Taglie:** M-L-XL-XXL  
**Tessuto:** 60% cotone 40% poliestere peso gr 270 m<sup>2</sup>  
**Applicazione:** edilizia, industria, cantieri stradali.  
**Packing:** in busta da 1 pezzo  
**Imballo minimo per ordine:** 1 pezzo  
**Scatola:** 20 pezzi per taglia - volume m<sup>3</sup> 0,10 - peso kg 9  
**Articolo dotato di codice a barre**



art. 384

[EN 20471]



Giubbotto arancio ad alta visibilità  
**Taglie:** S-M-L-XL-XXL-XXXL  
**Tessuto:** 60% cotone 40% poliestere peso gr 270 m<sup>2</sup>  
**Applicazione:** edilizia, industria, cantieri stradali.  
**Packing:** in busta da 1 pezzo  
**Imballo minimo per ordine:** 1 pezzo  
**Scatola:** 20 pezzi per taglia - volume m<sup>3</sup> 0,10 - peso kg 9  
**Articolo dotato di codice a barre**



art. 384F

[EN 20471]



Giubbotto arancio alta visibilità in fustagno.  
**Taglie:** S-M-L-XL-XXL-XXXL - **Tessuto:** Fustagno 60% cotone 40% poliestere peso gr 320 m<sup>2</sup>  
**Applicazione:** edilizia, industria, cantieri stradali.  
**Packing:** in busta da 1 pezzo  
**Imballo minimo per ordine:** 1 pezzo  
**Scatola:** 20 pezzi per taglia - volume m<sup>3</sup> 0,10 - peso kg 12  
**Articolo dotato di codice a barre**





art. 385BA

[EN 20471]



8 032668 104860



8 032668 104853



8 011818 130140



8 011818 143294



8 032668 103979

Pantalone alta visibilità bicolore  
60% cotone 40% poliestere,  
peso gr 270 m<sup>2</sup>

**Taglie:** S-M-L-XL-XXL

**Tessuto:** cotone/poliestere

**Applicazione:** edilizia, industria, cantieri stradali.

**Packing:** in busta da 1 pezzo

**Imballo minimo per ordine:** 1 pezzo

**Scatola:** 20 pezzi per taglia - volume m<sup>3</sup> 0,12 - peso kg 10

**Articolo dotato di codice a barre**



S-XXL

art. 385G

[EN 20471]



8 011818 112955



8 011818 112962



8 011818 112979



8 011818 112986

Pantalone giallo alta visibilità

**Taglie:** M-L-XL-XXL

**Tessuto:** 60% cotone 40% poliestere peso gr 270 m<sup>2</sup>

**Applicazione:** edilizia, industria, cantieri stradali.

**Packing:** in busta da 1 pezzo

**Imballo minimo per ordine:** 1 pezzo

**Scatola:** 20 pezzi per taglia - volume m<sup>3</sup> 0,10 - peso kg 9

**Articolo dotato di codice a barre**



M-XXL

art. 385

[EN 20471]



8 032668 104518



8 011818 100488



8 011818 100495



8 011818 100501



8 011818 100518



8 011818 148718

Pantalone arancio ad alta visibilità

**Taglie:** S-M-L-XL-XXL-XXXL

**Tessuto:** 60% cotone 40% poliestere peso gr 270 m<sup>2</sup>

**Applicazione:** edilizia, industria, cantieri stradali.

**Packing:** in busta da 1 pezzo

**Imballo minimo per ordine:** 1 pezzo

**Scatola:** 20 pezzi per taglia - volume m<sup>3</sup> 0,10 - peso kg 9

**Articolo dotato di codice a barre**



S-XXXL

art. 385F

[EN 20471]



8 011818 153262



8 011818 113723



8 011818 113730



8 011818 113747



8 011818 113754



8 011818 174762

Pantalone arancio alta visibilità in fustagno

**Taglie:** S-M-L-XL-XXL-XXXL

**Tessuto:** Fustagno 60% cotone 40% poliestere peso gr 320 m<sup>2</sup>

**Applicazione:** edilizia, industria, cantieri stradali.

**Packing:** in busta da 1 pezzo

**Imballo minimo per ordine:** 1 pezzo

**Scatola:** 20 pezzi per taglia - volume m<sup>3</sup> 0,10 - peso kg 12

**Articolo dotato di codice a barre**



S-XXXL

## art. 146AV SH03 2

[EN 20471]



Bermuda arancio ad alta visibilità.

**Taglie:** M-L-XL-XXL

**Tessuto:** nylon

**Imbottitura:** 60% cotone - 40% poliestere

**Applicazione:** edilizia, industria, cantieri stradali.

**Packing:** in busta da 1 pezzo

**Peso:** 270 gr

**Imballo minimo per ordine:** 1 pezzo

**Scatola:** 10 pezzi per taglia - volume m<sup>3</sup> 0,10 - peso kg 7

**Articolo dotato di codice a barre.**



M-XXL

## art. 14FLUO



UNICA



Cappellino invernale arancio ad alta visibilità con visiera e con banda riflettente reflexite.

**Taglia:** unica

**Tessuto:** cotone / poliestere

**Applicazione:** edilizia, cantieri.

**Packing:** in busta da 1 pezzo

**Imballo minimo per ordine:** 1 pezzo

**Scatola:** 12 pezzi - volume m<sup>3</sup> 0,07 - peso kg 5

**Codice a barre su richiesta**



UNICA

## art. 15FLUO



UNICA



Cappellino estivo arancio ad alta visibilità con visiera e con banda riflettente reflexite

**Taglia:** unica

**Tessuto:** cotone / poliestere

**Applicazione:** edilizia, cantieri.

**Packing:** in busta da 1 pezzo

**Imballo minimo per ordine:** 1 pezzo

**Scatola:** 12 pezzi - volume m<sup>3</sup> 0,07 - peso kg 5

**Codice a barre su richiesta**



UNICA

## art. 14RA

[EN 812]



UNICA



Cappellino con supporto antiurto. Resistenza 12,5 Joule - Colore arancio

**Taglia:** unica regolabile

**Materiale:** poliestere/cotone + calotta in polietilene

**Applicazione:** edilizia, cantieri.

**Packing:** in busta da 1 pezzo

**Imballo minimo per ordine:** 1 pezzo

**Scatola:** 10 pezzi - volume m<sup>3</sup> 0,05 - peso kg 5

**Articolo dotato di codice a barre**



UNICA

● art. 103ARV ● art. 103GV

[EN 20471]



art. 103ARV - ARANCIO

art. 103GV - GIALLO

M

M



8 011818 144857



8 011818 144895

L

L



8 011818 144864



8 011818 144901

XL

XL



8 011818 144871



8 011818 144918

XXL

XXL



8 011818 144888



8 011818 144925

Completo giacca e pantalone impermeabile in 100% poliestere oxford spalmato in pvc.

**Taglie:** M-L-XL-XXL

**Tessuto:** poliestere/pvc

**Applicazione:** edilizia, lavorazioni stradali, industria.

**Packing:** in busta da 1 pezzo

**Imballo minimo per ordine:** 1 pezzo

**Scatola:** 20 pezzi per taglia

- volume m<sup>3</sup> 0,12 - peso kg 8

**Articolo dotato di codice a barre**



M-XXL

# INDICE

Norme Calzature.....	pag. 190
Calzature con punta e soletta antiforo in composito.....	pag. 193
Calzature con punta in acciaio e soletta tessile antiforo.....	pag. 199
Calzature con punta in composito e soletta tessile antiforo.....	pag. 202
Calzature con punta rinforzata e soletta antiforo.....	pag. 203
Calzature con punta e soletta antiforo in composito.....	pag. 204
Calzature con punta e lamina in composito.....	pag. 207
Calzature con punta in composito e soletta antiforo.....	pag. 208
Calzature con punta e soletta antiforo in composito.....	pag. 209
Calzature con puntale rinforzato e lamina antiforo.....	pag. 215
Calzature con punta acciaio e soletta tessile antiforo.....	pag. 216
Calzature con punta rinforzata e soletta antiforo.....	pag. 217
Calzature con punta acciaio lamina antiforo.....	pag. 218
Calzature con puntale e lamina in acciaio.....	pag. 218
Calzature con punta acciaio lamina tessuto.....	pag. 221
Calzature con puntale rinforzato e soletta antiforo.....	pag. 222
Calzature con puntale in composito.....	pag. 223
Calzature settore alimentare/sanitario.....	pag. 224
Zoccoli.....	pag. 227
Calzature no Safety.....	pag. 228
Zoccoli.....	pag. 229
Stivali.....	pag. 232
Sottopiedi.....	pag. 244
Calze.....	pag. 246



CAZZATURE  
CAZZATURE

FOOTWEAR



SEBA

## Normative EN

### EN ISO 20345:2011

Calzature con protezione delle dita contro un urto di 200 J

CATEGORIE	RISCHI COPERTI
<b>SB</b>	
<b>S1</b>	A + FO + E
<b>S1P</b>	A + FO + E + P
<b>S2</b>	A + FO + E + WRU
<b>S2P</b>	A + FO + E + WRU + P (Suola senza rilievi)
<b>S3</b>	A + FO + E + WRU + P
<b>S4</b>	A + FO + E + Tenuta all'acqua
<b>S5</b>	A + FO + E + P + Tenuta all'acqua
<b>A</b>	Calzatura antistatica
<b>E</b>	Assorbimento di energia nella zona del tallone
<b>FO</b>	Suola resistente agli idrocarburi

CATEGORIE	RISCHI COPERTI
<b>P</b>	Lamina antiperforazione
<b>HRO</b>	Battistrada resistente al calore per contatto
<b>CI</b>	Isolamento dal freddo del fondo della calzatura
<b>HI</b>	Isolamento dal calore del fondo della calzatura
<b>WR</b>	Calzatura water resistant - cuciture sigillate - materiali idrorepellenti
<b>WRU</b>	Materiale tomaia impermeabile
<b>M</b>	Calzatura con protezione metatarsale
<b>CR</b>	Tomaia resistente al taglio
<b>SRC</b>	(SRA+SRB) Calzatura resistente allo scivolamento

### TEST DI CAMMINATA

1.000 passi (ca. 20 min.) in una vasca con 3 cm di acqua  
EN ISO 20345:2011 EN ISO 20347:2012



### EN20347 : 2012

Calzature senza puntale di protezione

CATEGORIE	RISCHI COPERTI
<b>OB</b>	
<b>01</b>	A + E
<b>01P</b>	A + E + P
<b>02</b>	A + E + WRU
<b>02P</b>	A + E + WRU + P (Suola senza rilievi)
<b>03</b>	A + E + WRU + P
<b>04</b>	A + E + Tenuta all'acqua
<b>05</b>	A + E + P + Tenuta all'acqua
<b>A</b>	Calzatura antistatica
<b>E</b>	Assorbimento di energia nella zona del tallone
<b>FO</b>	Suola resistente agli idrocarburi

CATEGORIE	RISCHI COPERTI
<b>P</b>	Lamina antiperforazione
<b>HRO</b>	Battistrada resistente al calore per contatto
<b>CI</b>	Isolamento dal freddo del fondo della calzatura
<b>HI</b>	Isolamento dal calore del fondo della calzatura
<b>WR</b>	Calzatura water resistant
<b>WRU</b>	Materiale tomaia impermeabile
<b>M</b>	Calzatura con protezione metatarsale
<b>CR</b>	Tomaia resistente al taglio
<b>SRC</b>	(SRA+SRB) Calzatura resistente allo scivolamento
<b>WR</b>	- cuciture sigillate - materiali idrorepellenti

### TEST DI CAMMINATA

1.000 passi (ca. 20 min.) in una vasca con 3 cm di acqua  
EN ISO 20345:2011 EN ISO 20347:2012

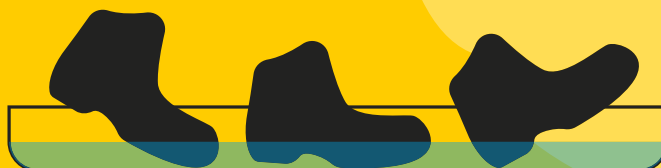





# SETTORI DI UTILIZZO

 INDUSTRIA ALIMENTRE  
RISTORAZIONE

 ANTITAGLIO

 ANTIFIAMMA  
RESISTENZA AL CALORE

 CANTIERI NAVALI

 INDUSTRIA CHIMICA  
FARMACEUTICA

 CANTIERI E LAVORI EDILI

 INDUSTRIA ELETTRONICA  
ELETTRICISTI

 AGRICOLTURA  
GIARDINAGGIO

 INDUSTRIA

 LAVORAZIONI PESANTI

 CANTIERI STRADALI

 MAGAZZINO

 MECCANICA

 OFFICINA MECCANICA

 LAVORI DI PRECISIONE

 PULIZIE

 SALDATURA

 TEMPO LIBERO

 TRASPORTI

# LEGENDA SIMBOLI

 IDROREPELENTE

 SOLETTA ANTIFORO

 PROTEZIONE METATARSO

 PUNTALE RINFORZATO

 SFILAMENTO RAPIDO

 SUOLA ANTICALORE

 SUOLA ANTISTATICA

 SUOLA IN GOMMA

 LAVAGGIO A 30°C

 ANTISCIVOLO

 PARTI IN PELLE-CUOIO

 CALZATURE LEGGERE

 NO METAL

 RESISTENZA A  
BASSE TEMPERATURE

 TAGLIE

<b>PU</b>	POLIURETANO
<b>PVC</b>	PVC
<b>GOMMA RUBBER</b>	GOMMA
<b>NITRILE</b>	NITRILE
<b>POLYGUM</b>	GOMMA NITRILICA







# CAZZARE FOOTWEAR

## art. 570CE

[EN ISO 20345  
S1P HRO SRC]



36 - 47



36 8 011818 173413	37 8 011818 173420	38 8 011818 173437
39 8 011818 173444	40 8 011818 173451	41 8 011818 173468
42 8 011818 173475	43 8 011818 173482	44 8 011818 173499
45 8 011818 173505	46 8 011818 173512	47 8 011818 173529

Calzatura bassa con puntale in composito e soletta tessile antiforo.

Tomaia in pelle scamosciata traspirante.

Suola in gomma bi-colore antistatica, antiscivolo, anticalore.

**Peso:** gr. 460 nella taglia 42

**Applicazione:** manutenzione, industria, settore elettrico.

**Taglie :** 36/47

**Imballo minimo per ordine:** 1 paio

**Volume scatola:** 0,16 m3 - 6 paia kg. 9

**Articolo dotato di codice a barre.**



[EN ISO 20345  
S1P SRC]

## art. 574CE



36 8 011818 167375	37 8 011818 167382	38 8 011818 167399
39 8 011818 167405	40 8 011818 167412	41 8 011818 167429
42 8 011818 167436	43 8 011818 167443	44 8 011818 167450
45 8 011818 167467	46 8 011818 167474	47 8 011818 167481

Calzatura bassa con puntale in composito e soletta tessile antiforo. Tomaia in pelle scamosciata e microfibra traspirante. Retina interna antisudore.

Suola in poliuretano bi-densità antistatica, antiscivolo.

**Peso:** gr. 480 nella taglia 42

**Taglie :** 36/47

**Applicazione:** manutenzione, industria, settore elettrico.

**Imballo minimo per ordine:** 1 paio

**Volume scatola:** 0,16 m3 - 6 paia kg. 10

**Articolo dotato di codice a barre.**



36 - 47



## art. 573CE

[EN ISO 20345  
S1P SRC]



36 8 011818 167252	37 8 011818 167269	38 8 011818 167276	39 8 011818 167283
40 8 011818 167290	41 8 011818 167306	42 8 011818 167313	
43 8 011818 167320	44 8 011818 167337	45 8 011818 167344	
46 8 011818 167351	47 8 011818 167368		

Calzatura bassa con puntale in composito e soletta tessile antiforo. Tomaia in pelle scamosciata e microfibra traspirante. Retina interna antisudore.

Suola in poliuretano bi-densità antistatica, antiscivolo.

**Peso:** gr. 480 nella taglia 42

**Taglie :** 36/47

**Applicazione:** manutenzione, industria, settore elettrico.

**Imballo minimo per ordine:** 1 paio

**Volume scatola:** 0,16 m3 - 6 paia kg. 10

**Articolo dotato di codice a barre.**



36 - 47



## art. 572CE

[EN ISO 20345  
S1P SRC]



36 - 47

36 8 011818 167610	37 8 011818 167627	38 8 011818 167634
39 8 011818 167641	40 8 011818 167658	41 8 011818 167665
42 8 011818 167672	43 8 011818 167689	44 8 011818 167696
45 8 011818 167702	46 8 011818 167719	47 8 011818 167726

Calzatura bassa con puntale in composito e soletta tessile antiforo. Tomaia in pelle scamosciata, retina e microfibra traspirante  
Suola in poliuretano bi-densità antistatica, antiscivolo.

**Peso:** gr. 470 nella taglia 42

**Taglie:** 36/47

**Applicazione:** manutenzione, industria, settore elettrico.

**Imballo minimo per ordine:** 1 paio

**Volume scatola:** 0,16 m<sup>3</sup> - 6 paia kg. 9

**Articolo dotato di codice a barre.**



## art. 571CE

[EN ISO 20345  
S1P SRC]



36 - 47

36 8 011818 167498	37 8 011818 167504	38 8 011818 167511
39 8 011818 167528	40 8 011818 167535	41 8 011818 167542
42 8 011818 167559	43 8 011818 167566	44 8 011818 167573
45 8 011818 167580	46 8 011818 167597	47 8 011818 167603

Calzatura bassa con puntale in composito e soletta tessile antiforo. Tomaia in pelle scamosciata, retina e microfibra traspirante Suola in poliuretano bi-densità antistatica, antiscivolo.

**Peso:** gr. 470 nella taglia 42

**Applicazione:** manutenzione, industria, settore elettrico.

**Taglie:** 36/47

**Imballo minimo per ordine:** 1 paio

**Volume scatola:** 0,16 m<sup>3</sup> - 6 paia kg. 9

**Articolo dotato di codice a barre.**



art. 568CE

[EN ISO 20345  
S1P HRO SRC]



36 - 47

36 8 011818 173178	37 8 011818 173185	38 8 011818 173192
39 8 011818 173208	40 8 011818 173215	41 8 011818 173222
42 8 011818 173239	43 8 011818 173246	44 8 011818 173253
45 8 011818 173260	46 8 011818 173277	47 8 011818 173284



Calzatura bassa con puntale in composito e soletta tessile antiforo.  
Tomaia in similpelle e retina traspirante.  
Suola in gomma bi-colore antistatica, antiscivolo, anticalore.  
**Peso:** gr. 460 nella taglia 42  
**Applicazione:** manutenzione, industria, settore elettrico.  
**Taglie:** 36/47  
**Imballo minimo per ordine:** 1 paio  
**Volume scatola:** 0,16 m3 - 6 paia kg. 9  
**Articolo dotato di codice a barre e confezione in blister appendibile**

art. 569CE

[EN ISO 20345  
S1P HRO SRC]



36 - 47

36 8 011818 173291	37 8 011818 173307	38 8 011818 173314
39 8 011818 173321	40 8 011818 173338	41 8 011818 173345
42 8 011818 173352	43 8 011818 173369	44 8 011818 173376
45 8 011818 173383	46 8 011818 173390	47 8 011818 173406

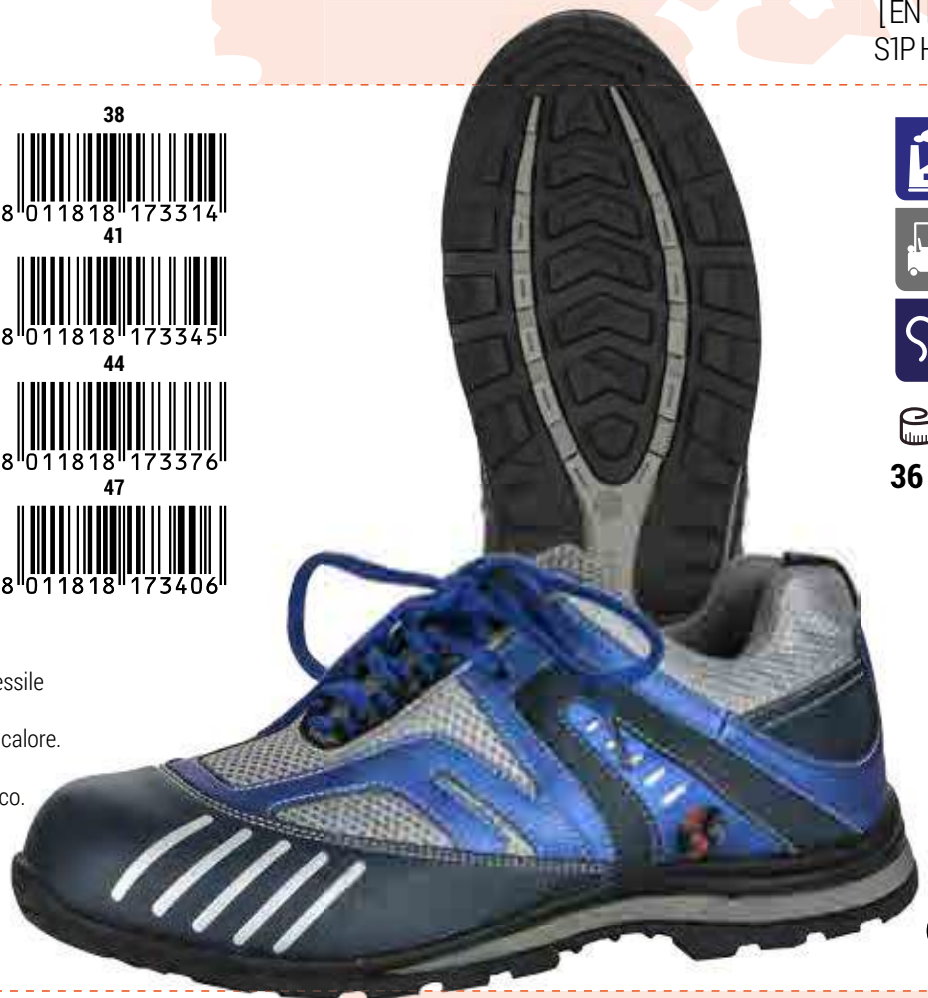

Calzatura bassa con puntale in composito e soletta tessile antiforo.  
Tomaia in similpelle e retina traspirante.  
Suola in gomma bi-colore antistatica, antiscivolo, anticalore.  
**Peso:** gr. 460 nella taglia 42  
**Applicazione:** manutenzione, industria, settore elettrico.  
**Taglie:** 36/47  
**Imballo minimo per ordine:** 1 paio  
**Volume scatola:** 0,16 m3 - 6 paia kg. 9  
**Articolo dotato di codice a barre e confezione in blister appendibile**

### art. 641CE

[EN ISO 20345  
S3 HRO SRC]



36 8 011818 164664	37 8 011818 164671	38 8 011818 163216
39 8 011818 163223	40 8 011818 164664	41 8 011818 163247
42 8 011818 163254	43 8 011818 163261	44 8 011818 163278
45 8 011818 163285	46 8 011818 163292	47 8 011818 163308

36 - 47



CE

Scarpa bassa bicolore in pieno fiore nabuck, con puntale in composito e sottopiede tessile antiforo. Suola in gomma /eva bicolore, antiscivolo, antistatica, antiolio, anticalore. Peso nella taglia 43, grammi 460 c.ca.

**Taglia:** 36-47 - **Applicazione:** edilizia, magazzinaggio, manutenzione, professionisti, agricoltura.

**Packing:** 6 paia - **Imballo minimo per ordine:** 6 paia

**Scatola:** 6 paia per volume m3 0,10 kg.9 - **Articolo dotato di codice a barre**

### art. 641ACE

[EN ISO 20345  
S3 HRO SRC]



36 8 011818 166293	37 8 011818 166309	38 8 011818 166316
39 8 011818 166323	40 8 011818 166330	41 8 011818 166347
42 8 011818 166354	43 8 011818 166361	
44 8 011818 166378	45 8 011818 166385	
46 8 011818 166392	47 8 011818 166408	

36 - 47



CE

Scarpa alta bicolore in pieno fiore nabuck, con puntale in composito e sottopiede tessile antiforo. Suola in gomma /eva bicolore, antiscivolo, antistatica, antiolio, anticalore. Peso nella taglia 43, grammi 470 c.ca.

**Taglia:** 36-47 - **Applicazione:** edilizia, magazzinaggio, manutenzione, professionisti, agricoltura.

**Packing:** 6 paia - **Imballo minimo per ordine:** 6 paia

**Scatola:** 6 paia per volume m3 0,10 kg.9,5

**Articolo dotato di codice a barre**

art. 589BCE

[ EN ISO 20345  
S1P SRC ]



36	37	38
8 011818 165173 39	8 011818 165180 40	8 011818 165197 41
8 011818 165203 42	8 011818 165210 43	8 011818 165227 44
8 011818 165234 45	8 011818 165241 46	8 011818 165258 47
8 011818 165265	8 011818 165272	8 011818 165289



36 - 47

Calzatura bassa con puntale in composito e soletta tessile antiforo.  
Tomaia in pelle scamosciata e retina traspirante.  
Suola in poliuretano antistatica, antiscivolo.

**Peso:** gr. 460 nella taglia 42  
**Applicazione:** edilizia, agricoltura..  
**Taglie :** 36/47  
**Imballo minimo per ordine:** 1 paio  
**Volume scatola:** 0,16 m3 - 6 paia kg. 9  
**Articolo dotato di codice a barre.**



art. 589CE

[ EN ISO 20345  
S1P SRC ]



36	37	38
8 011818 165050 39	8 011818 165067 40	8 011818 165074 41
8 011818 165081 42	8 011818 165098 43	8 011818 165104 44
8 011818 165111 45	8 011818 165128 46	8 011818 165135 47
8 011818 165142	8 011818 165159	8 011818 165166

36 - 47



Calzatura bassa con puntale in composito e soletta tessile antiforo.  
Tomaia in pelle scamosciata e retina traspirante.  
Suola in poliuretano antistatica, antiscivolo.

**Peso:** gr. 460 nella taglia 42  
**Applicazione:** Edilizia, agricoltura.  
**Taglie :** 36/47  
**Imballo minimo per ordine:** 1 paio  
**Volume scatola:** 0,16 m3 - 6 paia kg. 9  
**Articolo dotato di codice a barre.**





## art. 599CE

[ EN ISO 20345  
S1P SRC ]



36 8 011818 168938	37 8 011818 168945	38 8 011818 168952
39 8 011818 168969	40 8 011818 168976	41 8 011818 168983
42 8 011818 168990	43 8 011818 169003	44 8 011818 169010
45 8 011818 169027	46 8 011818 169034	47 8 011818 175547



36 - 47



Calzatura bassa con puntale in acciaio e soletta tessile antiforo.  
Tomaia in pelle scamosciata traspirante.

Suola in poliuretano bi-densità antistatica, antiscivolo.

**Peso:** gr. 490 nella taglia 42

**Applicazione:** : industria, magazzini, officina meccanica.

**Taglie :** 36/47 - **Imballo minimo per ordine:** 1 paio

**Volume scatola:** 0,16 m3 - 6 paia kg. 11

**Articolo dotato di codice a barre.**



## art. 599FCE

[ EN ISO 20345  
S3 SRC ]



38 8 011818 173666	39 8 011818 173673	40 8 011818 173680
41 8 011818 173697	42 8 011818 173703	43 8 011818 173710
44 8 011818 173727	45 8 011818 173734	46 8 011818 173741



38 - 46

Calzatura bassa con puntale in acciaio e soletta tessile antiforo.  
Tomaia in pelle nabuk idrorepellente e traspirante.

Suola in poliuretano bi-densità antistatica, antiscivolo.

**Peso:** gr. 490 nella taglia 42

**Applicazione:** : industria, magazzini, officina meccanica.

**Taglie :** 38/46 - **Imballo minimo per ordine:** 1 paio

**Volume scatola:** 0,16 m3 - 6 paia kg. 11

**Articolo dotato di codice a barre.**



art. 598CE

[ EN ISO 20345  
S1P SRC ]



36- 46

36 8 011818 169041	37 8 011818 169058	38 8 011818 169065
39 8 011818 169072	40 8 011818 169089	41 8 011818 169096
42 8 011818 169102	43 8 011818 169119	44 8 011818 169126
45 8 011818 169133	46 8 011818 169140	

Calzatura bassa con puntale in acciaio e soletta tessile antiforo.  
Tomaia in pelle scamosciata traspirante.  
Suola in poliuretano bi-densità antistatica, antiscivolo.  
**Peso:** gr. 490 nella taglia 42  
**Applicazione:** manutenzione, agricoltura, edilizia.  
**Taglie :** 36/46  
**Imballo minimo per ordine:** 1 paio  
**Volume scatola:** 0,16 m3 - 6 paia kg. 11  
**Articolo dotato di codice a barre.**



art. 598FCE

[ EN ISO 20345  
S3 SRC ]



38 - 46

38 8 011818 173567	39 8 011818 173574	40 8 011818 173581
41 8 011818 173598	42 8 011818 173604	43 8 011818 173611
44 8 011818 173628	45 8 011818 173635	46 8 011818 173642

Calzatura bassa in pelle fiore di nabuk con puntale in acciaio e soletta tessile antiforo. Suola in poliuretano bi-densità antistatica, antiolio, antiacido, antiscivolo.  
**Applicazione:** manutenzione, agricoltura, edilizia.  
**Peso:** gr. 490 nella taglia 42  
**Taglie :** 38/46  
**Imballo minimo per ordine:** 1 paio  
**Volume scatola:** 0,16 m3 - 6 paia kg. 11  
**Articolo dotato di codice a barre.**



art. 597CE

[ EN ISO 20345  
S1P SRC ]



36- 46

36 8 011818 169157	37 8 011818 169164	38 8 011818 169171
39 8 011818 169188	40 8 011818 169195	41 8 011818 169201
42 8 011818 169218	43 8 011818 169225	44 8 011818 169232
45 8 011818 169249	46 8 011818 169256	

Calzatura bassa con puntale in acciaio e soletta tessile antiforo.  
Tomaia in pelle scamosciata traspirante.  
Suola in poliuretano bi-densità antistatica, antiscivolo.  
**Peso:** gr. 490 nella taglia 42  
**Applicazione:** manutenzione, agricoltura, edilizia.  
**Taglie :** 36/46  
**Imballo minimo per ordine:** 1 paio  
**Volume scatola:** 0,16 m3 - 6 paia kg. 11  
**Articolo dotato di codice a barre.**



[EN ISO 20345  
S3 SRC]

## art. 635GNCE



34 8 011818 162011	35 8 011818 162028	36 8 011818 162035
37 8 011818 162042	38 8 011818 162059	39 8 011818 162066
40 8 011818 162073	41 8 011818 162080	42 8 011818 162097
43 8 011818 162103	44 8 011818 162110	45 8 011818 162127
46 8 011818 162134	47 8 011818 162141	

34 - 47



CE

Calzatura color grigio/nero  
alta con puntale e soletta tessile antiforo NO METAL.  
Tomaio in pelle scamosciata idrorepellente. Suola tipo FLAT in  
poliuretano antiscivolo, antiolio, antiacido, antistatica.  
Peso nella taglia 43 c.ca 470 gr.  
**Applicazioni:** edilizia- industria - magazzino- settore elettrico.  
**Misura:** 34/47 - **Imballo minimo per ordine :** 1 paio  
**Volume scatola:** 010 m<sup>3</sup> ( 6 paia ) - kg. 7  
**Articolo dotato di codice a barre**

## art. 634GNCE

[EN ISO 20345  
S3 SRC]



34 8 011818 161878	35 8 011818 161885	36 8 011818 161892
37 8 011818 161908	38 8 011818 161915	39 8 011818 161922
40 8 011818 161939	41 8 011818 161946	42 8 011818 161953
43 8 011818 161960	44 8 011818 161977	45 8 011818 161984
46 8 011818 161991	47 8 011818 162004	

34 - 47



CE

Calzatura bassa color grigio/nero con puntale e soletta tessile antiforo NO METAL.  
Tomaio in pelle scamosciata idrorepellente. Suola tipo FLAT in poliuretano antiscivolo,  
antioolio, antiacido, antistatica. Peso nella taglia 43 c.ca 480 gr.  
**Applicazioni:** edilizia- industria - magazzino, settore elettrico.  
**Misura:** 34/47 - **Imballo minimo per ordine :** 1 paio  
**Volume scatola:** 010 m<sup>3</sup> ( 6 paia ) - kg. 7  
**Articolo dotato di codice a barre**

art. 632NCE

[EN ISO 20345 S3 HRO SRC]



38 - 47



38 8 011818 173888	39 8 011818 173895	40 8 011818 173901
41 8 011818 173918	42 8 011818 173925	43 8 011818 173932
44 8 011818 173949	45 8 011818 173956	46 8 011818 173963
47 8 011818 173970		



Stivaletto imbottito nero in pelle fiore con puntale in composito e soletta tessile antiforo. Membrana interna idrorepellente e traspirante. Suola in gomma anticalore

**Applicazione:** industria, edilizia, lavorazioni pesanti

**Taglie:** 38/47

**Imballo minimo per ordine:** 1 paio

**Volume scatola:** 0,15 m3 - 6 paia kg. 15

**Articolo dotato di codice a barre.**

art. 404CE

[EN ISO 20345 - S3 HRO SRC]



39 8 011818 133110	43 8 011818 134384
40 8 011818 133127	44 8 011818 133141
41 8 011818 134377	45 8 011818 134391
42 8 011818 133134	



39 - 45

STIVALETTO PELLE S3 HRO ACQUASTOP  
Stivaletto ACQUASTOP per motoseghisti con puntale e lamina in acciaio. Tomaio in pelle vitello anfibio idrorepellente. Suola con particolare miscela anticalore, antiscivolo, antiolio, antiacido, antistatica. Membrana interna VERATEX impermeabile e traspirante

**Taglie:** 39/45

**Imballo minimo per ordine:** 1 paio

**Volume scatola:** m<sup>3</sup> 0,15 (6 paia) - peso kg 15

**Articolo dotato di codice a barre**

[EN ISO 20345  
S3 SRC]

art. 673CE

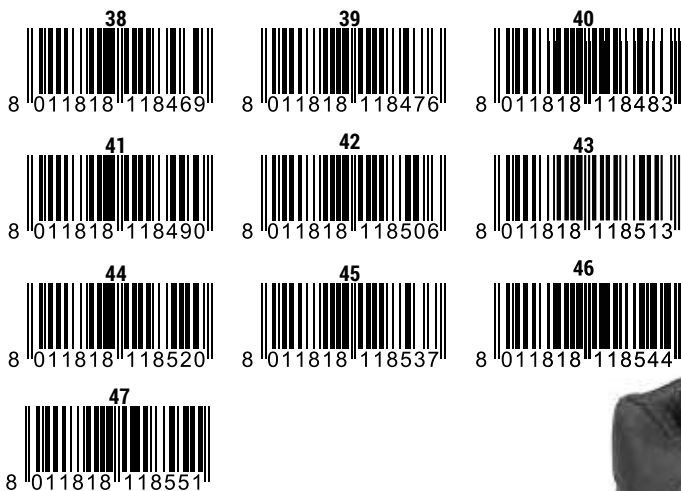

38 - 47

Calzatura HOT STUFF ®alta con puntale e lamina NON - METAL  
 Tomaio in pieno fiore nabuk  
 Calza interna in RESPIREX® impermeabile traspirante.  
 Punta e tallone rinforzati  
 Suola in TPU/PU bi-densità antiscivolo, antiolio, antiacido, antistatica. Peso nella TG. 42 540 gr circa.  
**Applicazioni:** edilizia - agricoltura.  
**Misura :** 38/47  
**Imballo minimo per ordine :** 1 paio  
**Volume scatola:** 0.10 m<sup>3</sup> (6 paia) - Kg.10  
**Articolo dotato di codice a barre**



art. 672CE

[EN ISO 20345  
S3 SRC]

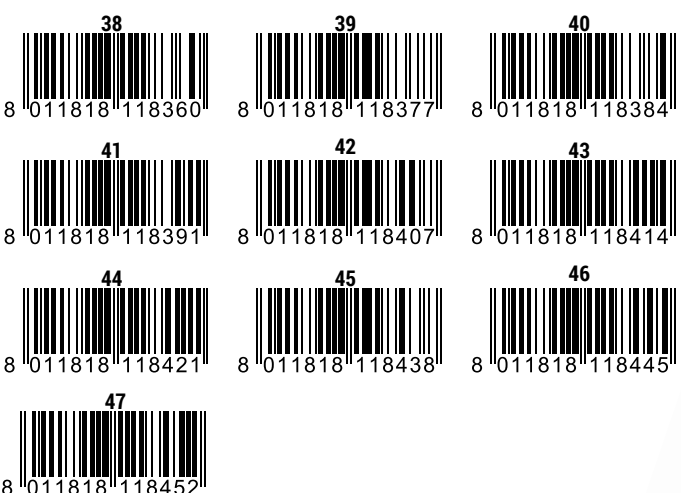

38 - 47

Calzatura HOT STUFF ®bassa con puntale e lamina NON - METAL  
 Tomaio in pieno fiore nabuk  
 Calza interna in RESPIREX® impermeabile traspirante.  
 Punta e tallone rinforzati  
 Suola in poliuretano bi-densità antiscivolo, antiolio, antiacido, antistatica. Peso nella TG. 42 530 gr circa.  
**Applicazione:** edilizia - agricoltura.  
**Misura :** 38/47  
**Imballo minimo per ordine :** 1 paio  
**Volume scatola:** 0.10 m<sup>3</sup> (6 paia) - Kg.10  
**Articolo dotato di codice a barre**



## art. 588NCE

[EN ISO 20345  
S3 SRC]



38 - 47



Calzatura bassa con puntale e lamina NON - METAL.  
Tomaio microfibra traspirante. Lavabile in lavatrice a 30°.  
Suola in poliuretano antiscivolo, antiolio, antiacido, antistatica.  
**Applicazioni:** industria, manutenzione, officine, settore elettrico.  
**Misura:** 38/47  
**Peso:** nella TG 42 430 gr. circa  
**Imballo minimo per ordine:** 1 paio  
**Volume scatola:** 0.10 m3 (6 paia) - Kg.10  
**Articolo dotato di codice a barre**

## art. 587CE

[EN ISO 20345  
S3 SRC]



38 - 47

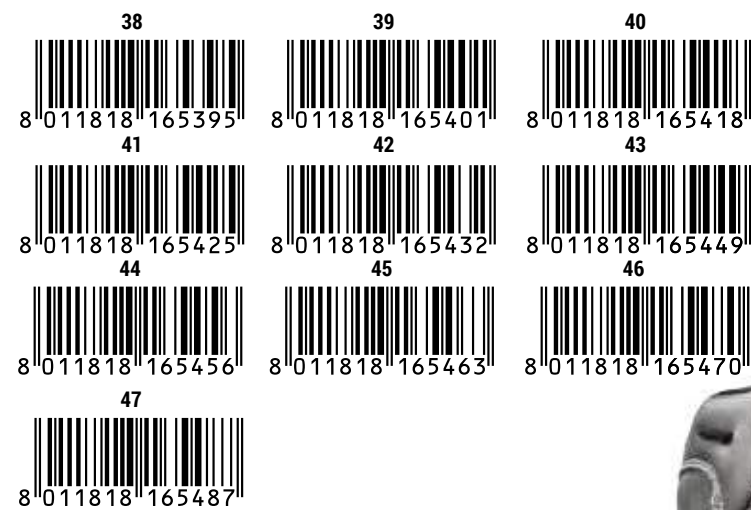

Calzatura alta con puntale e lamina NON - METAL. Tomaio microfibra traspirante. Lavabile in lavatrice a 30°. Suola in poliuretano antiscivolo, antiolio, antiacido, antistatica.  
**Applicazioni:** industria, manutenzione, officine, settore elettrico.  
**Misura:** 38/47 - **Peso:** nella TG 42 460 gr. circa  
**Imballo minimo per ordine:** 1 paio  
**Volume scatola:** 0.10 m3 (6 paia) - Kg.10  
**Articolo dotato di codice a barre**

[EN ISO 20345  
S3 SRC]

## art. 696CE

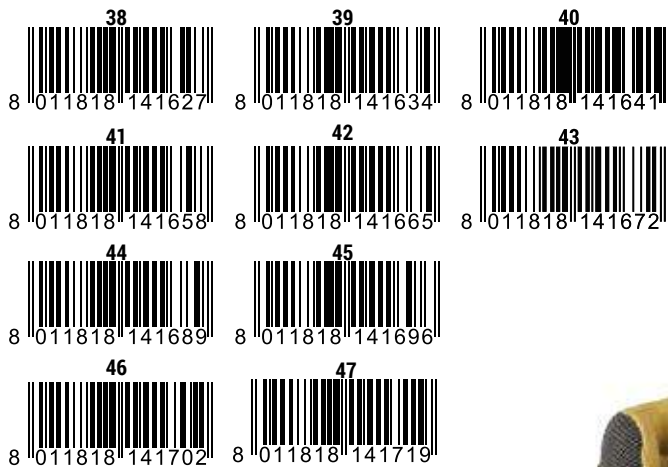

38 - 47

Scarpa bassa marrone in pieno fiore nabuck S3, con puntale in composito e sottopiede tessile antiforo. Suola in TPU/PU antiscivolo, antioilo, antiacido, antistatica

**Applicazioni:** edilizia, agricoltura.

**Misura:** 38/47

**Packing:** 1 paio - **Peso** nella TG 42 500 gr. circa.

**Imballo minimo per ordine:** da 6 paia per misura

**Volume scatola:** 0,10 m<sup>3</sup> ( 6 paia ) - Kg.10

**Articolo dotato di codice a barre**



## art. 695CE

[EN ISO 20345  
S3 SRC]



39 - 47

Scarpa alta in pieno fiore nabuck S3, con puntale in composito e sottopiede tessile antiforo e sostegno al tallone. Suola in TPU/PU antiscivolo, antioilo, antiacido, antistatica

**Applicazioni:** edilizia, agricoltura.

**Misura:** 39/47

**Packing:** 1 paio - **Peso** nella TG 42 500 gr. circa.

**Imballo minimo per ordine:** da 6 paia per misura

**Volume scatola:** 0,10 m<sup>3</sup> ( 6 paia ) - Kg.10

**Articolo dotato di codice a barre**





[EN ISO 20345 S3 SRC]

art. 697CE

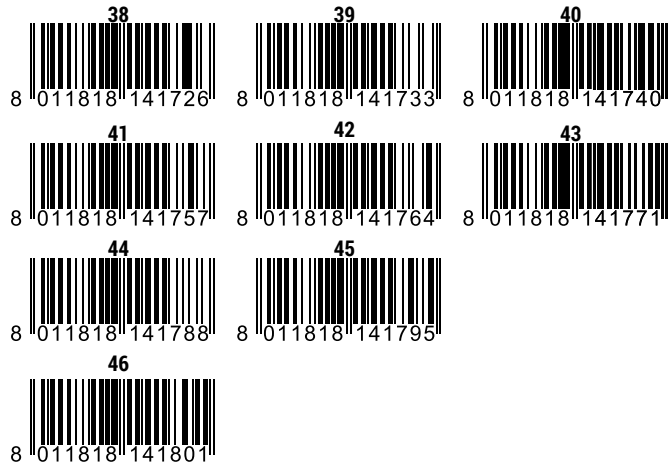

38 - 46



Scarpa bassa nera in pieno fiore nabuck S3, con puntale in composito e sottopiede tessile antiforo. Suola in TPU/PU antiscivolo, antiolio, antiacido, antistatica

**Applicazioni:** edilizia, industria, magazzinaggio, lavorazioni pesanti

**Misura :** 38/46

**Packing:** 1 paio **Peso:** gr. 500 nella taglia 42

**Imballo minimo per ordine:** da 6 paia per misura

**Volume scatola:** 0,10 m<sup>3</sup> ( 6 paia ) - Kg.10

**Articolo dotato di codice a barre**

art. 699CE

[EN ISO 20345 S3 SRC]

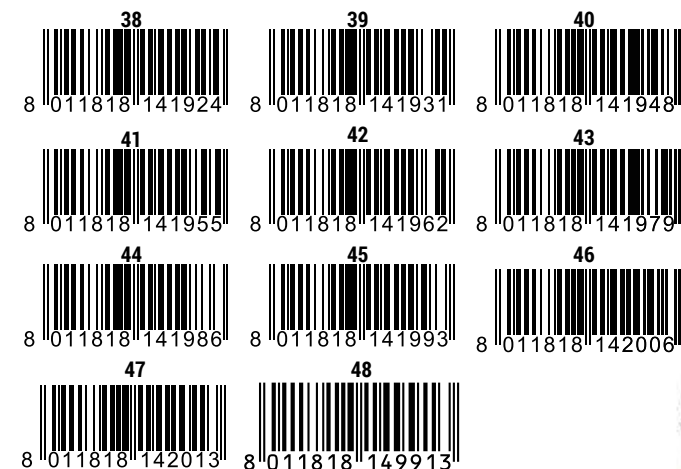

38 - 48



Scarpa alta in pieno fiore nabuck S3, con puntale in composito e sottopiede tessile antiforo e sostegno al tallone. Suola in TPU/PU antiscivolo, antiolio, antiacido, antistatica

**Applicazioni:** edilizia, industria, magazzinaggio, lavorazioni pesanti

**Misura :** 38/48

**Packing:** 1 paio **Peso:** gr. 500 nella taglia 42

**Imballo minimo per ordine:** da 6 paia per misura

**Volume scatola:** 0,10 m<sup>3</sup> ( 6 paia ) - Kg.10

**Articolo dotato di codice a barre**

## art. 588CE

[EN ISO 20345  
S3 SRC]



38 8 011818 165494 41	39 8 011818 165500 42	40 8 011818 165517 43
8 011818 165524 44	8 011818 165531 45	8 011818 165548 46
8 011818 165555 47	8 011818 165562	8 011818 165579
8 011818 165586		



38 - 47

Scarpa bassa in microfibra con puntale in composito e sottopiede tessile antiforo. Suola in POLIURETANO antiscivolo, antiolio, antiacido, antistatica.

**Applicazioni:** industria, magazzino, officine, settore elettrico.

**Misura :** 38/47

**Packing:** 1 paio - Peso nella TG 42 430 gr. circa.

**Imballo minimo per ordine:** da 6 paia per misura

**Volume scatola:** 0,10 m<sup>3</sup> ( 6 paia ) - Kg.9

**Articolo dotato di codice a barre**



CE

## art. 84NM

[EN ISO 20345  
S1P SRC]



36 8 011818 154672	37 8 011818 154689	38 8 011818 154696	39 8 011818 154702
40 8 011818 154719	41 8 011818 154726	42 8 011818 154733	
43 8 011818 154740	44 8 011818 154757	45 8 011818 154764	
46 8 011818 154771	47 8 011818 154788	48 8 011818 154795	



36 - 48

Calzatura bassa. Tomaia in vera pelle scamosciata areata c/retina interna. Per stagione estiva. Collarino con imbottitura morbida, puntale in materiale composito e sottopiede tessile antiforo. Suola in poliuretano bi-densità. Peso nella taglia 42, grammi 480 circa

**Applicazione:** edilizia, industria, magazzino.

**Misura:** 36/48

**Imballo minimo per ordine:** 1 paio

**Volume scatola:** 0,10 m<sup>3</sup> ( 6 paia ) - kg.10

**Articolo dotato di codice a barre**



CE

art. 685GCE

[EN ISO 20345  
SIP SRC]



39 - 47

39 8 011818 173994	40 8 011818 174007	41 8 011818 174014
42 8 011818 174021	43 8 011818 174038	44 8 011818 174045
45 8 011818 174052	46 8 011818 174069	47 8 011818 174076

Sandalo estivo con puntale e lamina NON - METAL  
Tomaio in scamosciato.  
Suola in pu/tpu antiscivolo, antiolio, antiacido,  
antistatica.

**Applicazioni:** edilizia, industria.

**Misura :** 39/47

**Peso:** gr. 500 nella taglia 42

**Imballo minimo per ordine :** 1 paio

**Volume scatola:** 0.10 m<sup>3</sup> (6 paia) - Kg.10

**Articolo dotato di codice a barre**



art. 685CE

[EN ISO 20345  
SIP SRC]



39 - 47

39 8 011818 119671	40 8 011818 119688	41 8 011818 119695
42 8 011818 119701	43 8 011818 119718	44 8 011818 119725
45 8 011818 119732	46 8 011818 119749	47 8 011818 119756

Sandalo estivo con puntale e lamina NON - METAL  
Tomaio in scamosciato.  
Suola in pu/tpu antiscivolo, antiolio, antiacido,  
antistatica.

**Applicazioni:** edilizia, industria.

**Misura :** 39/47

**Peso:** gr. 500 nella taglia 42

**Imballo minimo per ordine :** 1 paio

**Volume scatola:** 0.10 m<sup>3</sup> (6 paia) - Kg.10

**Articolo dotato di codice a barre**



[EN ISO 20345  
S3 SRC]

## art. 621NM



Scarpa alta S3 (NON METAL) in vera pelle con puntale in materiale composito e protezione antiforo tessile. Materassino alla caviglia imbottito. Suola in poliuretano bi-densità antiscivolo, antiolio, antiacido, antistatica

Peso nella taglia 43, grammi 510 circa.

**Taglie:** 38-48

**Applicazione:** Edilizia, industria, magazzino

**Packing:** 6 paia

**Imballo minimo per ordine:** 6 paia

**Scatola:** 6 paia volume m<sup>3</sup> 0,10 Kg. 9,5

**Articolo dotato di codice a barre**

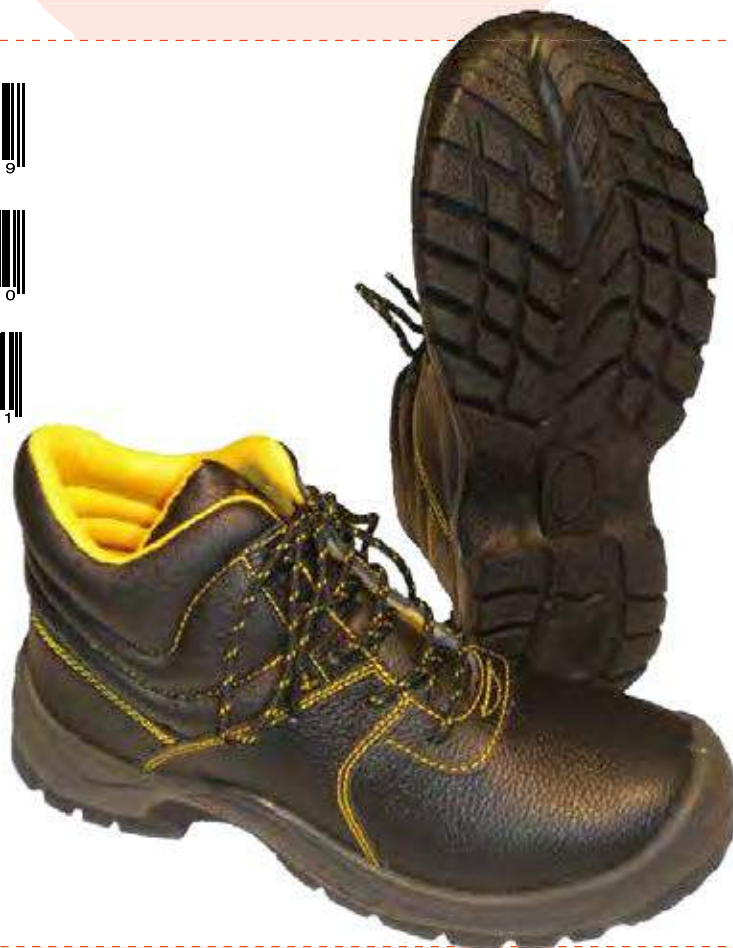

38 - 48



## art. 622NM

[EN ISO 20345  
S3 SRC]



Scarpa bassa S3 (NON METAL) in vera pelle con puntale in materiale composito e protezione antiforo tessile. Suola in poliuretano bi-densità antiscivolo, antiolio, antiacido, antistatica

Peso nella taglia 43, grammi 490 circa.

**Taglie:** 38-48

**Applicazione:** Edilizia, industria, magazzino

**Packing:** 6 paia

**Imballo minimo per ordine:** 6 paia

**Scatola:** 6 paia volume m 0,10 Kg.9

**Articolo dotato di codice a barre**

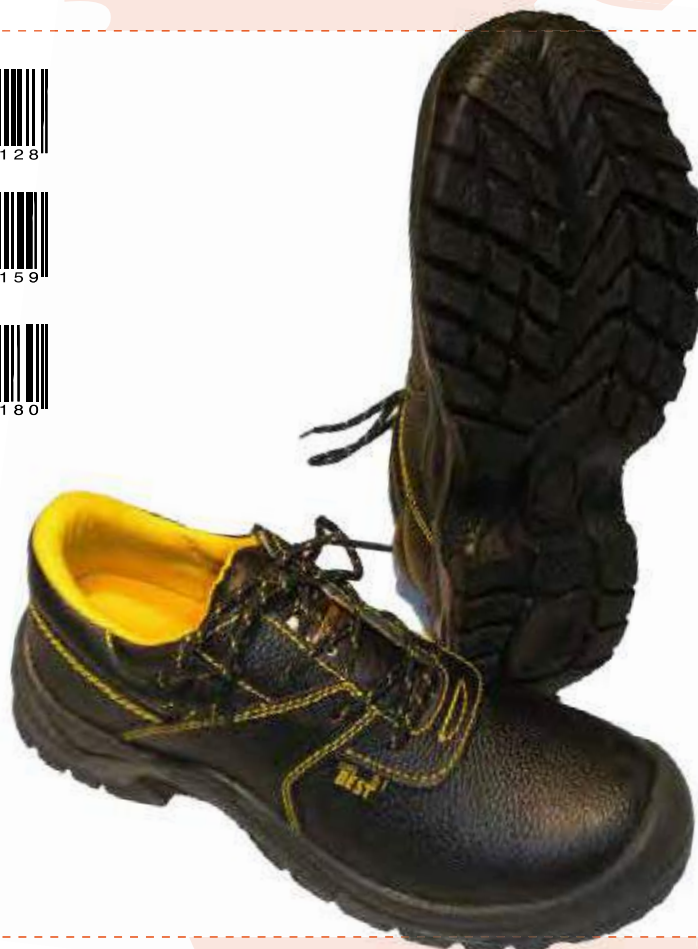

38 - 48



## art. 642ACE

[EN ISO 20345 S1P SRC]

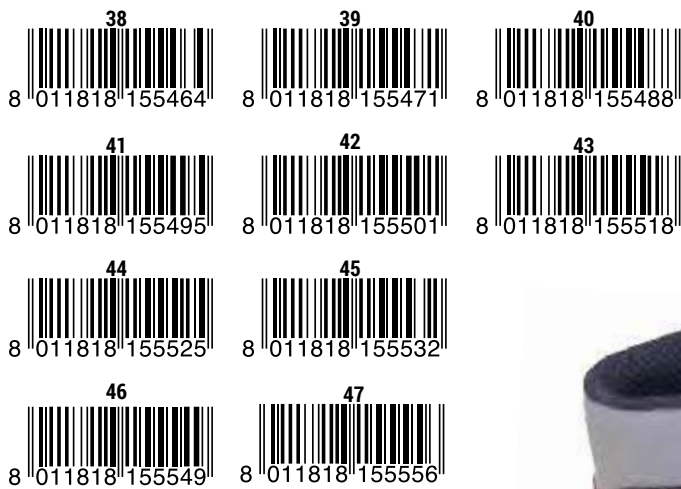

38 - 47



Calzatura alta con puntale e soletta tessile antiforo NO METAL.  
Tomaio in pelle scamosciata . Suola in poliuretano antiscivolo,  
antiolio, antiacido, antistatica.

Peso nella taglia 43 c.ca 510 gr.

**Applicazioni:** edilizia- industria - magazzino, officine

**Misura:** 38/47

**Imballo minimo per ordine :** 1 paio

**Volume scatola:** 010 m<sup>3</sup> ( 6 paia ) - kg. 8

**Articolo dotato di codice a barre**

## art. 642BCE

[EN ISO 20345 S1P SRC]

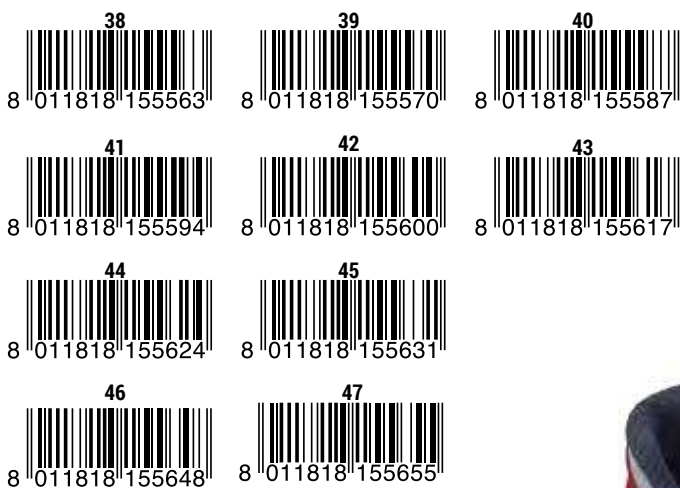

38 - 47



Calzatura bassa con puntale e soletta tessile antiforo NO METAL.  
Tomaio in pelle scamosciata . Suola in poliuretano antiscivolo,  
antiolio, antiacido, antistatica.

**Peso:** nella taglia 43 c.ca 500 gr.

**Applicazioni:** edilizia- industria - magazzino, officine.

**Misura:** 38/47

**Imballo minimo per ordine :** 1 paio

**Volume scatola:** 010 m<sup>3</sup> ( 6 paia ) - kg. 8

**Articolo dotato di codice a barre**

## art. 592NCE

[EN ISO 20345 S1P HRO SRC]

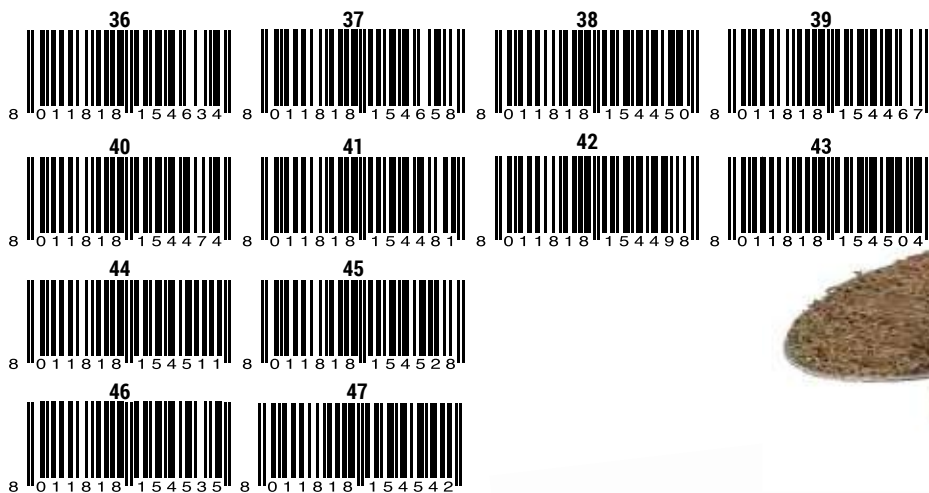

36 - 47

Calzatura bassa NO METAL in pelle scamosciata con suola in gomma/EVA bicolore. Puntale in materiale composito e sottopiede tessile antiforo. Soletta in cuoio e fibra di cocco. Suola antiscivolo, antistatica, antiolio, anticalore. Peso nella taglia 43, grammi 480 circa.

**Taglia:** 36-47

**Applicazione:** officine, manutenzione, magazzinaggio, professionisti, edilizia leggera, industria.

**Packing:** 6 paia - **Imballo minimo per ordine:** 6 paia

**Scatola:** 6 paia volume m<sup>3</sup> 0,10 Kg.8

**Articolo dotato di codice a barre e blister appendibile**



## art. 592CE

[EN ISO 20345 S1P HRO SRC]

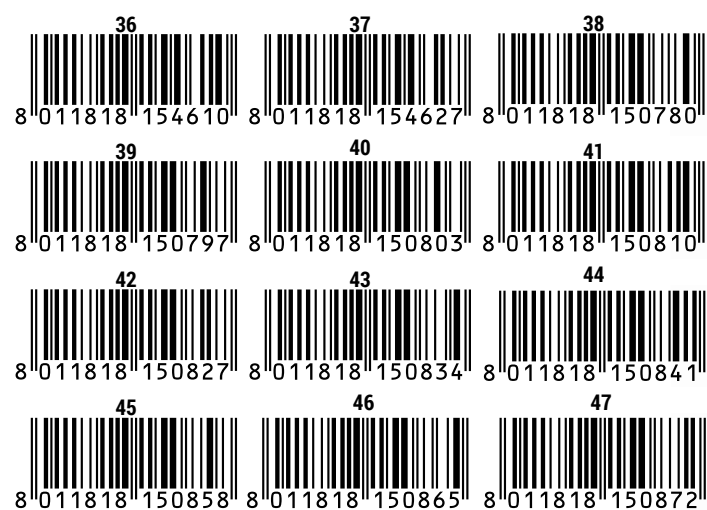

36 - 47

Calzatura bassa NO METAL in pelle scamosciata. Suola in gomma/EVA bicolore. Puntale in materiale composito e sottopiede tessile antiforo. Soletta in cuoio e fibra di cocco. Suola antiscivolo, antistatica, antiolio, anticalore.. Peso nella taglia 43, grammi 480 circa.

**Taglia:** 36-47

**Applicazione:** edilizia, magazzinaggio, professionisti, officine.

**Packing:** 6 paia

**Imballo minimo per ordine:** 6 paia

**Scatola:** 6 paia volume m<sup>3</sup> 0,10 Kg.8

**Articolo dotato di codice a barre e blister appendibile**



## art. 591CE

[EN ISO 20345 S1P HRO SRC]

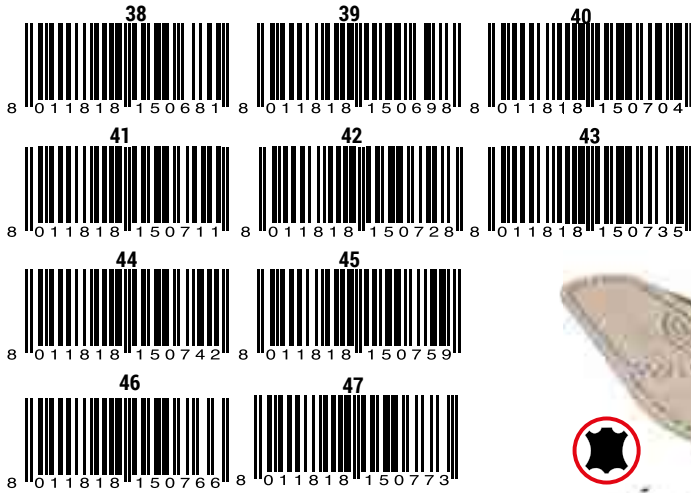

38 - 47

Calzatura bassa NO METAL in pelle scamosciata e tela traspirante. Suola in gomma/EVA bicolore. Puntale in materiale composito e sottopiede tessile antiforo. Suola antiscivolo, antistatica, antiolio, anticalore. Peso nella taglia 43, grammi 440 circa.  
**Taglia:** 38-47  
**Applicazione:** officine, manutenzione, magazzinaggio, professionisti, industria.  
**Packing:** 6 paia - **Imballo minimo per ordine:** 6 paia  
**Scatola:** 6 paia volume m<sup>3</sup> 0,10 Kg.7  
**Articolo dotato di codice a barre e blister appendibile**



## art. 591ACE

[EN ISO 20345 S1P HRO SRC]

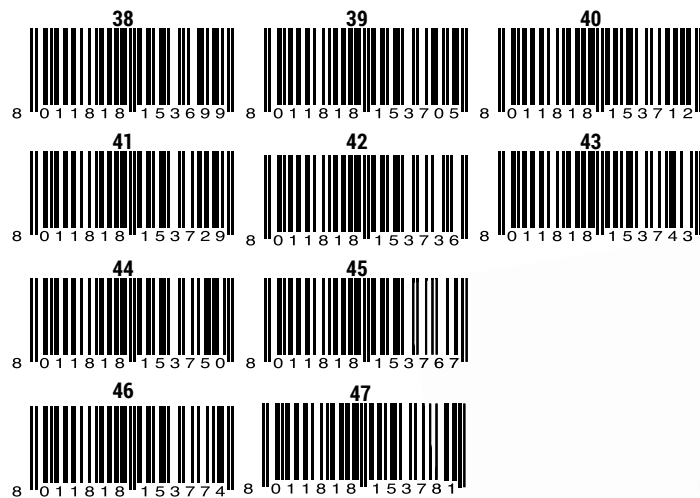

38 - 47

Calzatura alta NO METAL in pelle scamosciata e tela traspirante. Suola in gomma/EVA bicolore. Puntale in materiale composito e sottopiede tessile antiforo. Suola antiscivolo, antistatica, antiolio, anticalore. Peso nella taglia 43, grammi 460 circa.  
**Taglia:** 38-47  
**Applicazione:** officine, manutenzione, magazzinaggio, professionisti, industria.  
**Packing:** 6 paia  
**Imballo minimo per ordine:** 6 paia  
**Scatola:** 6 paia volume m<sup>3</sup> 0,10 Kg.7  
**Articolo dotato di codice a barre e blister appendibile**



[EN ISO 20345  
S3 SRC]

art. 594CE

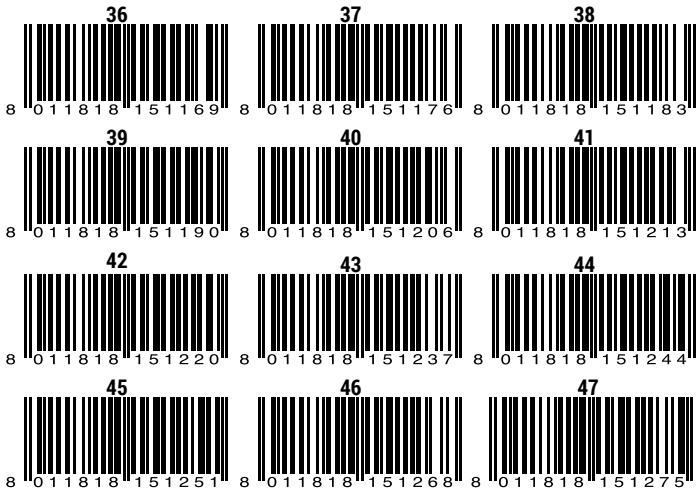

36 - 47



Calzatura bassa NO METAL Hot Stuff in pelle fiore di nabuck con suola in gomma/EVA bicolore. Puntale in materiale composito e sottopiede tessile antiforo. Suola antiscivolo, antistatica, antiolio, anticalore. Peso nella taglia 43, grammi 430 circa.

**Taglia:** 36-47

**Applicazione:** officine, manutenzione, magazzino, professionisti, edilizia leggera.

**Packing:** 6 paia

**Imballo minimo per ordine:** 6 paia

**Scatola:** 6 paia volume m<sup>3</sup> 0,10 Kg.7

**Articolo dotato di codice a barre**





art. 576CE

[EN ISO 20345  
S1P SRC]



36 8 011818 167733	37 8 011818 167740	38 8 011818 167757
39 8 011818 167764	40 8 011818 167788	41 8 011818 167795
42 8 011818 167801	43 8 011818 167818	44 8 011818 167825
45 8 011818 167832	46 8 011818 167849	47 8 011818 167856



36 - 47

Calzatura bassa con puntale e lamina antiforo in acciaio.  
Tomaia in pelle scamosciata con fori di aerazione. Retina interna antisudore.

Suola in poliuretano bi-densità antistatica, antiscivolo.

**Peso:** gr. 490 nella taglia 42

**Taglie:** 36/47

**Applicazione:** industria, edilizia, magazzini, officine.

**Imballo minimo per ordine:** 6 paia per taglia

**Volume scatola:** 0,16 m3 - 6 paia kg. 10

**Articolo dotato di codice a barre.**



art. 80NM

[EN ISO 20345  
S1P SRC]



39 8 412372 739945	40 8 412372 739952	41 8 412372 739969
42 8 412372 739976	43 8 412372 739983	
44 8 412372 739990	45 8 412372 740002	
46 8 412372 740019		



39 - 46

Calzatura alta con puntale in policarbonato e soletta tessile. Tomaia in pelle scamosciata.

Retina interna antisudore. Suola in poliuretano antistatica, antiscivolo.

**Peso:** gr. 480 nella taglia 42

**Taglie:** 39/46

**Applicazione:** industria, edilizia, magazzini, officine

**Imballo minimo per ordine:** 1 paio

**Volume scatola:** 0,16 m3 - 6 paia - kg. 9

**Articolo dotato di codice a barre.**



## art. 575CE

[EN ISO 20345  
SIP SRC]

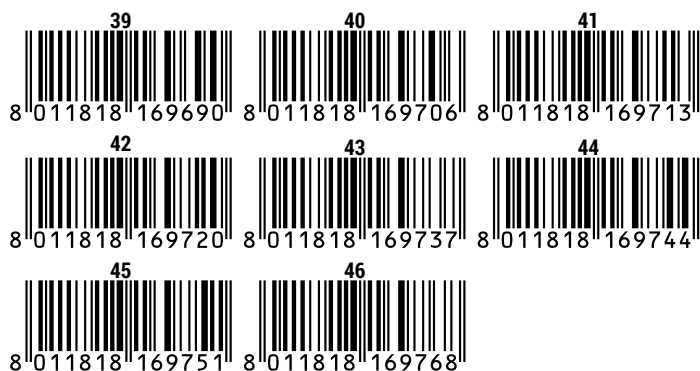

39 - 46

Calzatura bassa con puntale in acciaio e soletta tessile antiforo.  
Tomaia in pelle scamosciata  
Suola in poliuretano bi-densità antistatica, antiscivolo.  
**Peso:** gr. 490 nella taglia 42  
**Taglie :** 39/46  
**Applicazione:** edilizia, magazzini, agricoltura.  
**Imballo minimo per ordine:** 1 paio  
**Volume scatola:** 0,16 m3 - 6 paia kg. 9  
**Articolo dotato di codice a barre.**



CE

## art. 577CE

[EN ISO 20345  
SIP SRC]



39 - 46

Calzatura alta con puntale in acciaio e soletta tessile antiforo.  
Tomaia in pelle scamosciata con particolari riflettenti per la visione notturna. Retina interna antisudore.  
Suola in poliuretano bi-densità antistatica, antiscivolo.  
**Peso:** gr. 480 nella taglia 42  
**Taglie :** 39/46  
**APPLICAZIONE:** edilizia, magazzini, agricoltura.  
**Imballo minimo per ordine:** 1 paio  
**Volume scatola:** 0,16 m3 - 6 paia - kg. 10  
**Articolo dotato di codice a barre.**



CE

art. 578CE

[EN ISO 20345  
S3 SRC]



39 - 46



Calzatura alta con puntale in acciaio e soletta tessile antiforo. Tomaia in pelle nabuk di prima qualità. Retina interna antisudore. Suola in poliuretano bi-densità antistatica, antiscivolo.

**Peso:** gr. 480 nella taglia 42

**Taglie :** 39/46

**Applicazione:** edilizia, magazzini, agricoltura.

**Imballo minimo per ordine:** 1 paio

**Volume scatola :** 0,16 m<sup>3</sup> - 6 paia - kg. 9

**Articolo dotato di codice a barre.**

art. 671CE

[EN ISO 20345 S1P SRC]



35 - 48

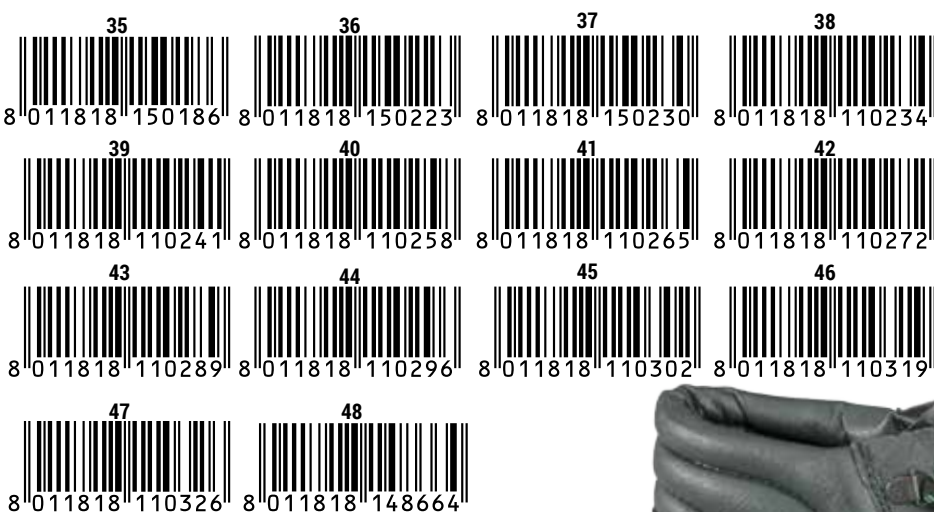

Calzatura alta con puntale e lamina in acciaio. Tomaia in pelle. Suola con spunterbo in poliuretano bi-densità antiscivolo, antiolio, antiacido, antistatica

**Taglie:** 35/48

**Applicazione:** industria, magazzini.

**Packing:** 1 paio - **Peso:** gr. 560 nella taglia 42

**Imballo minimo per ordine:** da 6 paia per misura

**Volume scatola:** m<sup>3</sup> 0,10 (6 paia) - peso kg 10

**Articolo dotato di codice a barre**

## art. 622FCE

[EN ISO 20345 S3 SRC]



36 - 47

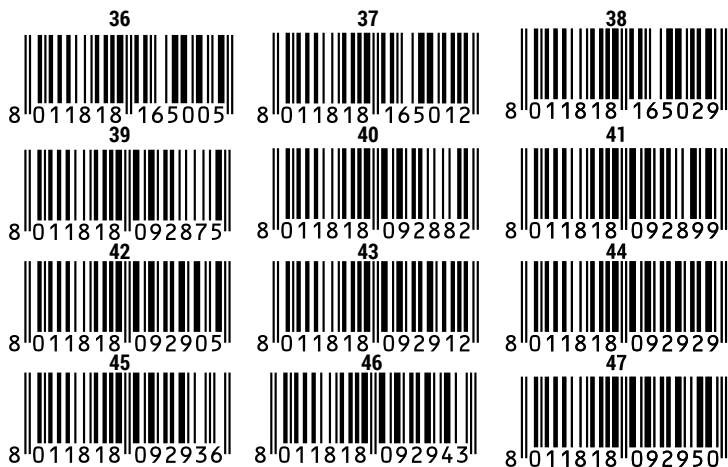

Calzatura bassa con puntale e lamina in acciaio.  
Tomaia in pelle idrorepellente. Suola con spunterbo in poliuretano bi-densità antiscivolo, antiolio, antiacido, antistatica

**Taglie:** 36/47

**Packing:** 1 paio **Peso** della TG 42 550 gr. circa.

**Applicazioni:** industria, magazzinaggio.

**Imballo minimo per ordine:** da 6 paia per misura

**Volume scatola:** m<sup>3</sup> 0,10 (6 paia) - peso kg 10

**Articolo dotato di codice a barre**



## art. 670CE

[EN ISO 20345 S1P SRC]



35 - 47

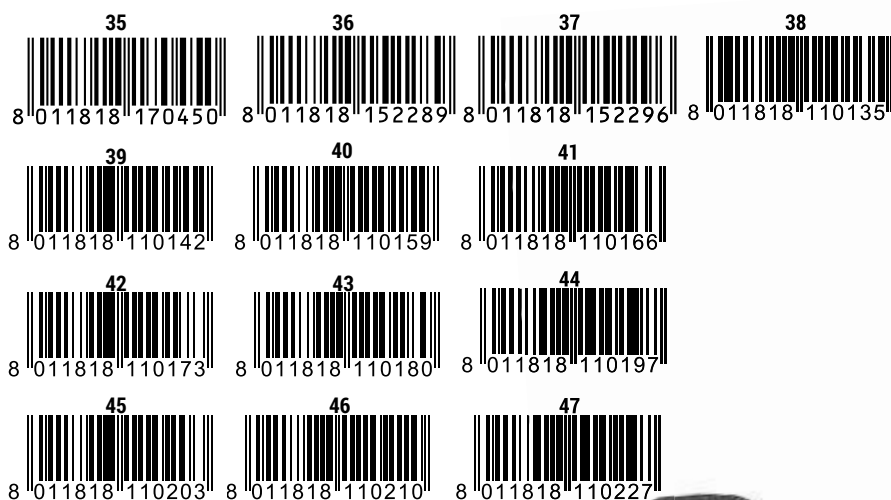

Calzatura bassa con puntale e lamina in acciaio. Tomaia in pelle. Suola con spunterbo in poliuretano bi-densità antiscivolo, antiolio, antiacido, antistatica.

**Applicazioni:** industria, magazzinaggio.

**Taglie:** 35/47

**Packing:** 1 paio - **Peso** della tg 42 550 gr c.ca

**Imballo minimo per ordine:** da 6 paia per misura

**Volume scatola:** m<sup>3</sup> 0,10 (6 paia) - peso kg 10

**Articolo dotato di codice a barre**



art. 621FCE

[ EN ISO 20345 S3 SRC ]



36 8 011818 155457	37 8 011818 009354	38 8 011818 096149
39 8 011818 093056	40 8 011818 093063	41 8 011818 093070
42 8 011818 093087	43 8 011818 093094	44 8 011818 093100
45 8 011818 093117	46 8 011818 093124	47 8 011818 105070

36 - 47

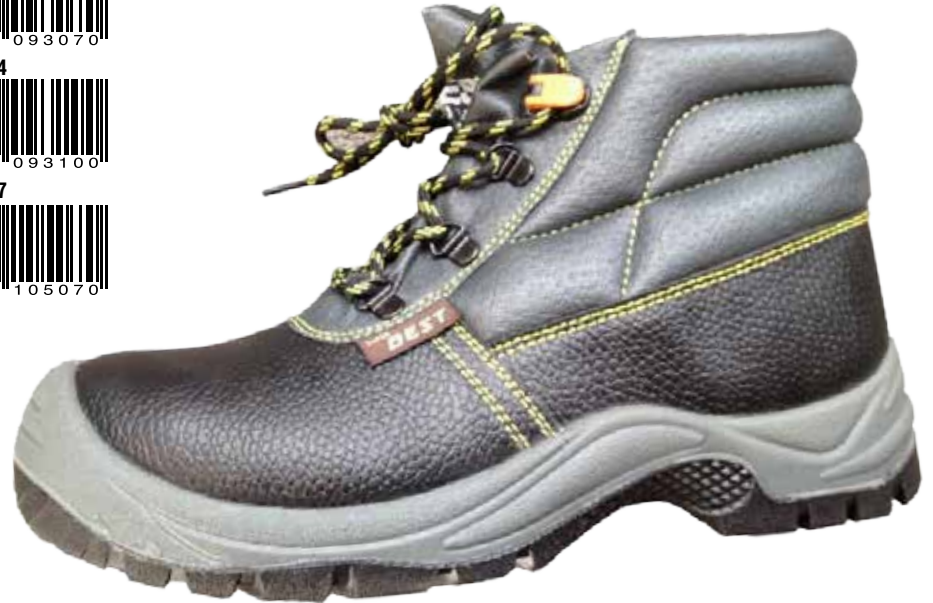

Calzatura alta con puntale e lamina in acciaio antiforo.  
Tomaia in pieno fiore, paramalleolo doppia imbottitura.  
Dispositivo di sfilamento rapido.  
Suola, con spunterbo, in PU bi-densità.  
Antiscivolo, antiolio, antiacido, antistatica.

**Taglie:** 36/47

**Applicazione:** industria, magazzini.

**Packing:** 1 paio - **Peso:** gr. 560 nella taglia 42

**Imballo minimo per ordine:** da 6 paia per misura

**Volume scatola:** m<sup>3</sup> 0,10 (6 paia) - peso kg 10

**Articolo dotato di codice a barre**

art. 84CE

[ EN ISO 20345 S1P SRC ]



36 8 011818 092158	37 8 011818 092165	38 8 011818 092172
39 8 011818 092189	40 8 011818 092196	41 8 011818 092202
42 8 011818 092219	43 8 011818 092226	44 8 011818 092233
45 8 011818 092240	46 8 011818 092257	47 8 011818 092264
48 8 011818 114805		

36 - 48



Calzatura bassa. Tomaia in vera pelle scamosciata areata c/retina interna. Per stagione estiva. Collarino con imbottitura morbida, puntale in acciaio e lamina antiforo. Suola in poliuretano bi-densità antistatica, antiacido, antiolio, antiscivolo. Lamina antiforo inox

**Taglie:** 36/48

**Applicazione:** industria, magazzini, edilizia.

**Packing:** 1 paio

**Imballo minimo per ordine:** da 6 paia per misura

**Volume scatola:** m<sup>3</sup> 0,10 (6 paia) - peso kg 10

**Articolo dotato di codice a barre**

## art. 692CE

[EN ISO 20345 S1P SRC]

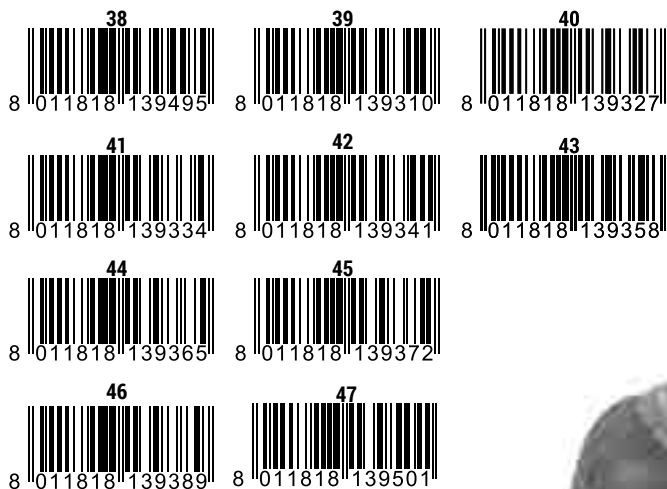

38 - 47



Scarpa alta trekking con puntale e lamina in acciaio. Tomaia in pelle scamosciata e nylon. Suola in poliuretano.

**Applicazioni:** edilizia, industria, magazzinaggio, agricoltura.

**Taglie:** 38/47

**Packing:** 1 paio - **Peso** della TG 42 520 gr. circa.

**Imballo minimo per ordine:** da 6 paia per misura

**Volume scatola:** 0,10 m<sup>3</sup> ( 6 paia ) - Kg.10

**Articolo dotato di codice a barre**

## art. 693CE

[EN ISO 20345 S1P SRC]

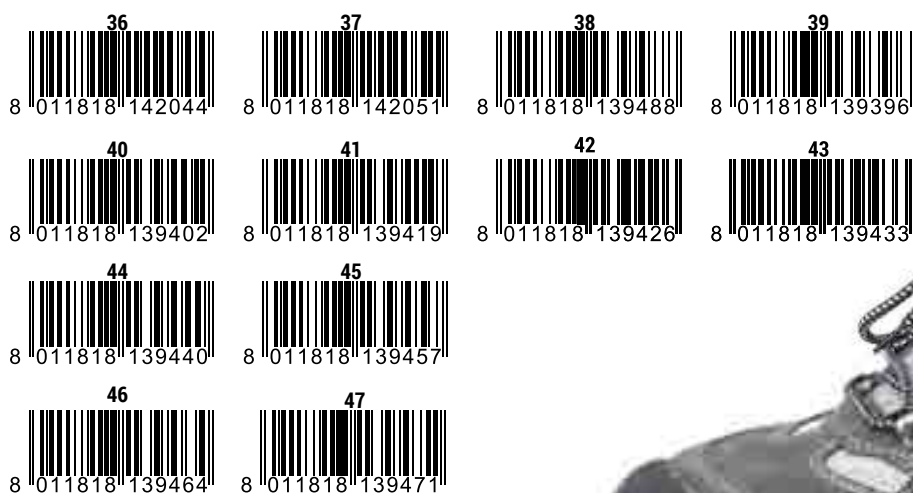

36 - 47



Scarpa bassa trekking con puntale e lamina in acciaio.

Tomaia in pelle scamosciata e nylon. Suola in poliuretano.

**Applicazioni:** edilizia, industria, magazzinaggio, agricoltura.

**Taglie:** 36/47

**Packing:** 1 paio - **Peso** della TG 42 510 gr. circa.

**Imballo minimo per ordine:** da 6 paia per misura

**Volume scatola:** 0,10 m<sup>3</sup> ( 6 paia ) - Kg.10

**Articolo dotato di codice a barre**

art. 72CE

[EN ISO 20345 S1P SRC]



38 8 011818 113891	39 8 011818 113907	40 8 011818 113914	41 8 011818 113921
42 8 011818 113938	43 8 011818 113945	44 8 011818 113952	
45 8 011818 113969	46 8 011818 113976	47 8 011818 113983	



38 - 47



Calzatura bassa. Tomaia in vera pelle scamosciata areata c/retina interna. Per stagione estiva. Collarino con imbottitura morbida, puntale in acciaio e lamina antiforo. Suola in poliuretano bi-densità, antistatica, antiacido, antiolio, antiscivolo.

**Applicazioni:** edilizia, industria, magazzinaggio, agricoltura.

**Misure:** 38/47

**Packing:** 1 paio - **Peso:** gr. 510 nella taglia 42

**Imballo minimo per ordine:** da 6 paia per misura

**Volume scatola:** 0.10 m<sup>3</sup> (6 paia) - **Peso Kg.** 10

**Articolo dotato di codice a barre**

art. 71CE

[EN ISO 20345 - S1P SRC]



36 8 011818 092509	37 8 011818 092516	38 8 011818 092523	39 8 011818 092530
40 8 011818 092547	41 8 011818 092554	42 8 011818 092561	43 8 011818 092578
44 8 011818 092585	45 8 011818 092592	46 8 011818 092608	



36 - 46



Sandalo in pelle scamosciata con puntale e lamina. Suola in poliuretano bidensità antiscivolo, antiolio, antiacido, antistatica.

**Taglie:** 36/46

**Applicazioni:** edilizia, industria, magazzinaggio.

**Packing:** 1 paio - **Peso:** gr. 500 nella taglia 42

**Imballo minimo per ordine:** da 6 paia per misura

**Volume scatola:** m<sup>3</sup> 0,10 (6 paia) - **peso kg** 9

**Articolo dotato di codice a barre**

art. 644FBCE

[EN ISO 20345 - S1 SRC]



39 - 47

Calzatura alta S1 con fibbia e puntale in acciaio.  
Tomaia in vera pelle naturale, paramalleolo doppia imbottitura.  
Protezione metatarso contro scorie di saldatura. Suola in poliuretano bi-densità antistatica, antiolio, antiscivolo, antiacido.  
**Applicazioni:** edilizia, saldatura, industria pesante, navale.  
**Packing:** 1 paio - **Peso** della TG 42 530 gr. circa.  
**Imballo minimo per ordine:** da 6 paia per misura  
**Volume scatola:** m<sup>3</sup> 0,10 (6 paia) - peso kg 10  
**Articolo dotato di codice a barre**



art. 645CE

[EN ISO 20345 S3 HRO SRC]

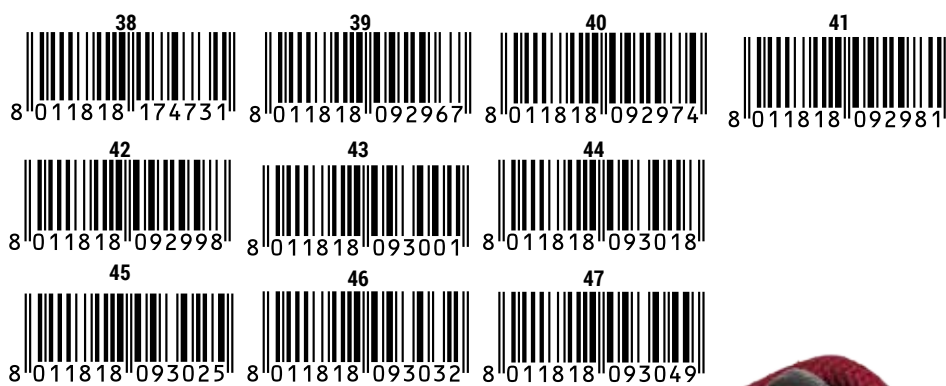

38 - 47

Calzatura alta con puntale composito e soletta tessile antiforo. Tomaia in vera pelle idrorepellente.  
Chiusura frontale mediante velcro® contro scorie di saldatura. Suola anticalore in gomma.  
**Applicazioni:** edilizia, saldatura, industria pesante, navale.  
**Packing:** 1 paio - **Peso** della TG 42 540 gr. circa.  
**Imballo minimo per ordine:** da 6 paia per misura  
**Volume scatola:** m<sup>3</sup> 0,10 (6 paia) - peso kg 11  
**Articolo dotato di codice a barre**





art. 624NSLCE

[EN ISO 20345 S2 SRC]

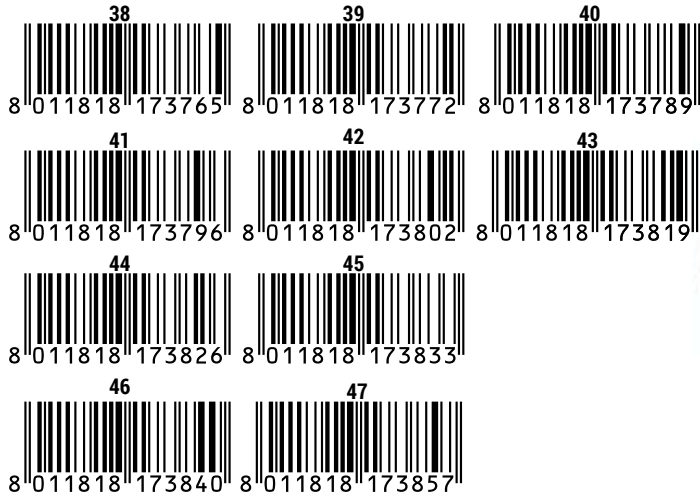

38 - 47



Calzatura bassa senza lacci. Tomaia in microfibra lavabile in lavatrice a 30°C. Puntaie in policarbonato, suola in poliuretano, antiolio, antiacido, antistatica.

**Applicazioni:** industria, magazzino.

**Packing:** 1 paio - **Peso** della TG 42 490 gr. circa.

**Imballo minimo per ordine:** da 6 paia per misura

**Volume scatola:** m<sup>3</sup> 0,10 (6 paia) - peso kg 9

**Articolo dotato di codice a barre**

ACCESSORI

art. 15



Coprimetatarso. Coprilacci parascintille. Ideale per operatori alla saldatura e fonderia. Protegge la zona dei lacci dalla caduta di scintille o gocce di materiale incandescente

**Imballo minimo per ordine:** 10 paia

**Volume scatola:** m<sup>3</sup> 0,03 (10 paia) - peso kg 0,5

**Articolo dotato di codice a barre**

art. 128CE



Borsone multipiano a tre scomparti, in nylon.

Base 52, profondità 32, altezza 48 cm.

**Imballo minimo per ordine:** 1 PZ.

**Volume scatola:** m<sup>3</sup> 0,03 - peso kg 2

**Articolo dotato di codice a barre**

art. 624SLNMCE

[EN ISO 20345 - S3]



36 - 47

36 8 011818 162813	37 8 011818 162820	38 8 011818 162837
39 8 011818 162844	40 8 011818 162851	41 8 011818 162868
42 8 011818 162875	43 8 011818 162882	44 8 011818 162899
45 8 011818 162905	46 8 011818 162912	47 8 011818 162929

Calzatura bassa con puntale in composito e soletta tessile antiforo. Tomaia in MICROFIBRA traspirante. Suola in gomma nitrilica trasparente antistatica, antiscivolo, anticalore, antiacido.

**Peso:** gr. 430 nella taglia 42

**Applicazione:** settore alimentare - imbianchini.

**Taglie :** 36/47

**Imballo minimo per ordine:** 1 paio

**Volume scatola:** 0,16 m3 - 6 paia kg. 9

**Articolo dotato di codice a barre.**



art. 625NMCE

[EN ISO 20345 - S2]



36 - 47

36 8 011818 163094	37 8 011818 163100	38 8 011818 163117
39 8 011818 163124	40 8 011818 163131	41 8 011818 163148
42 8 011818 163155	43 8 011818 163162	44 8 011818 163179
45 8 011818 163186	46 8 011818 163193	47 8 011818 163209

Sandalo con puntale in composito Tomaia in MICROFIBRA traspirante. Suola in gomma nitrilica trasparente antistatica, antiscivolo, anticalore, antiacido.

**Peso:** gr. 430 nella taglia 42

**Applicazione:** settore alimentare - imbianchini.

**Taglie :** 36/47

**Imballo minimo per ordine:** 1 paio

**Volume scatola:** 0,16 m3 - 6 paia kg. 9

**Articolo dotato di codice a barre.**



art. 625CE

[EN ISO 20345 - S2 - SRC]



35 - 47



Sandalo con puntale in acciaio. Tomaia in microfibra traspirante e idrorepellente completa di cinturino. Suola in poliuretano espanso antistatico e antiscivolo iniettato direttamente alla tomaia.

Il suddetto articolo è prodotto con materiali speciali, che ne permettono il lavaggio in lavatrice, alla temperatura di 30°C

**Taglie:** 35/47

**Applicazioni:** settore alimentare, sanitario, laboratori.

**Packing:** 1 paio - **Peso:** gr. 510 nella taglia 42

**Imballo minimo per ordine:** 1 paio

**Volume scatola:** m<sup>3</sup> 0,10 (6 paia) - peso kg 10

**Articolo dotato di codice a barre**



art. 624SLCE

[EN ISO 20345 - S2 - SRC]

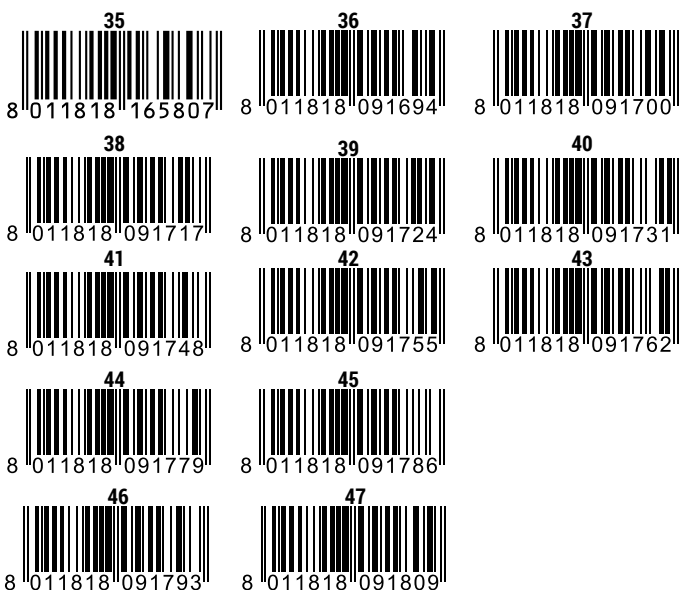

35 - 47



Calzatura bassa bianca idrorepellente con puntale in acciaio, tomaia in microfibra. Suola in PU monodensità antistatica, antiacido, antiolio, antiscivolo.

**Applicazioni:** indicata nelle seguenti lavorazioni: della carne, casearia, alimentare, farmaceutica, ecc

**Packing:** 1 paio - **Peso:** gr. 520 nella taglia 42

**Taglie:** 35/47

**Imballo minimo per ordine:** 1 paio

**Volume scatola:** m<sup>3</sup> 0,10 (6 paia) - peso kg 10

**Articolo dotato di codice a barre**



## art. 0250CE



36 8 011818 121902	37 8 011818 121919	38 8 011818 121926	39 8 011818 121933	40 8 011818 121940
41 8 011818 121957	42 8 011818 121964	43 8 011818 121971	44 8 011818 121988	
45 8 011818 121995	46 8 011818 122008			
47 8 011818 150391				



36 - 47



Zoccolo in pelle traforata traspirante e sottopiede in scamosciato. Suola in poliuretano.

**Applicazione:** tempo libero, industria farmaceutica, sanità.

**Taglie:** 36/47

**Imballo minimo per ordine:** 6 paia per misura.

**Volume scatola:** 0,10 m<sup>3</sup> - 6 paia kg. 7

**Articolo dotato di codice a barre.**

## art. 0260CE

[EN ISO 20347 - SRA]



35/36 8 011818 170573	37/38 8 011818 121131
39/40 8 011818 121148	41/42 8 011818 121155
43/44 8 011818 121162	45/46 8 011818 121179
47/48 8 011818 121186	



35 - 48



Zoccolo in polivinile autoclavabile a 130°C, sterilizzabile. Indicato per: alimentaristi, macellai, sanitari, ospedalieri. Colore Bianco

**Taglie:** 35/48

**Imballo minimo per ordine:** 1 paio

**Volume scatola:** m<sup>3</sup> 0,10 (6 paia) - peso kg 10

**Articolo dotato di codice a barre**



35 - 48

## art. 0250BLU



36 - 47

Zoccolo in pelle traforata traspirante e sottopiede in scamosciato. Suola in poliuretano.

**Applicazione:** tempo libero, industria farmaceutica, sanità.

**Taglie :** 36/47

**Imballo minimo per ordine:** 6 paia per misura.

**Volume scatola:** 0,10 m<sup>3</sup> - 6 paia kg. 7

**Articolo dotato di codice a barre.**



## art. 0260VE-CE

[EN ISO 20347 - SRA]



35 - 48



Zoccolo in polivinile autoclavabile a 130°C, sterilizzabile. Indicato per: alimentaristi, macellai, sanitari, ospedalieri.

Colore VERDE

**Taglie:** 35/48

**Imballo minimo per ordine:** 1 paio

**Volume scatola:** m<sup>3</sup> 0,10 (6 paia) - peso kg 10

**Articolo dotato di codice a barre**



## art. 0260BL-CE

[EN ISO 20347 - SRA]



35 - 48



Zoccolo in polivinile autoclavabile a 130°C, sterilizzabile. Indicato per: alimentaristi, macellai, sanitari, ospedalieri.

Colore BLU

**Taglie:** 35/48

**Imballo minimo per ordine:** 1 paio

**Volume scatola:** m<sup>3</sup> 0,10 (6 paia) - peso kg 10

**Articolo dotato di codice a barre**



## art. 604C - NO SAFETY



36 8 011818 168129	37 8 011818 168136	38 8 011818 168143
39 8 011818 168150	40 8 011818 168167	41 8 011818 168174
42 8 011818 168181	43 8 011818 168198	44 8 011818 168204
45 8 011818 168211	46 8 011818 168228	47 8 011818 175127

Calzatura bassa in pelle scamosciata di prima qualità beige.  
Suola in poliuretano EVA  
**Taglie:** 36/47  
**Packaging:** 1 paio  
**Imballo minimo per ordine:** 6 paia per misura  
**Volume scatola:** m<sup>3</sup> 0,08 (6 paia) - peso kg 7  
**Articolo dotato di codice a barre**



36 - 47

## art. 604B - NO SAFETY



36 8 011818 168013	37 8 011818 168020	38 8 011818 168037
39 8 011818 168044	40 8 011818 168051	41 8 011818 168068
42 8 011818 168075	43 8 011818 168082	44 8 011818 168099
45 8 011818 168105	46 8 011818 168112	47 8 011818 175318

Calzatura bassa in pelle scamosciata di prima qualità blu.  
Suola in poliuretano EVA  
**Taglie:** 36/47  
**Packaging:** 1 paio  
**Imballo minimo per ordine:** 6 paia per misura  
**Volume scatola:** m<sup>3</sup> 0,08 (6 paia) - peso kg 7  
**Articolo dotato di codice a barre**



36 - 47

## art. 674

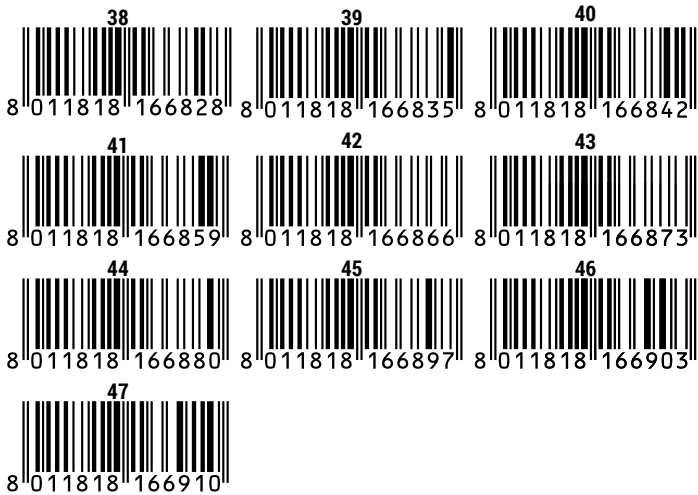

Calzatura alta da trekking e tempo libero. Tomaia in pelle bovina idrorepellente di primissima qualità con fodera interna a calza WR idrorepellente e traspirante. Tallone rinforzato in TPU. Suola in poliuretano bidensità. Calzatura molto robusta, ma confortevole e leggera allo stesso tempo, che la rende superiore rispetto a calzature simili presenti in commercio.

**Applicazioni:** agricoltura, attività forestali, giardinaggio.

**Packing:** 1 paio

**Taglie:** 38/47

**Imballo minimo per ordine:** 6 paia per misura

**Volume scatola:** m<sup>3</sup> 0,10 (6 paia) - peso kg 9

**Articolo dotato di codice a barre**



38 - 47

## art. 656A



[EN ISO 20347 - SRA]

  
38 - 47

Calzatura alta senza puntale e senza lamina. Tomaia in pelle. Suola in poliuretano bi-densità antiscivolo, antiolio, antiacido, antistatica. Consigliata nel settore agricolo

**Taglie:** 38/47

**Packing:** 1 paio

**Imballo minimo per ordine:** da 6 paia per misura

**Volume scatola:** m<sup>3</sup> 0,10 (6 paia) - peso kg 10

**Articolo dotato di codice a barre**

## art. 39



39 8 011818 174649	40 8 011818 174656	41 8 011818 174663
42 8 011818 174670	43 8 011818 174687	44 8 011818 174694
45 8 011818 174700	46 8 011818 174717	



39 - 46

Stivale anfibo impermeabile con scafo e suola in poliuretano, senza puntale e lamina. Parte superiore in tessuto impermeabile. Interno foderato in agnello acrilico.

**Applicazione:** agricoltura/giardinaggio, tempo libero

**Taglie :** 39/46

**Imballo minimo per ordine:** 1 paio

**Volume scatola:** 0,16 m3 - 6 paia kg. 9

**Articolo dotato di codice a barre.**



## art. 38S



39 8 011818 172317	40 8 011818 172324	41 8 011818 172331
42 8 011818 172348	43 8 011818 172355	44 8 011818 172362
45 8 011818 172379	46 8 011818 172386	



39 - 46

Stivale anfibo impermeabile con scafo e suola in poliuretano, senza puntale e lamina. Parte superiore in tessuto mimetico impermeabile. Interno foderato in agnello acrilico.

**Applicazione:** agricoltura/giardinaggio, tempo libero

**Taglie :** 39/46

**Imballo minimo per ordine:** 1 paio

**Volume scatola:** 0,16 m3 - 6 paia kg. 9

**Articolo dotato di codice a barre.**





## art. 12F



38 8 011818 171679	39 8 011818 171686	40 8 011818 171693
41 8 011818 171709	42 8 011818 171716	43 8 011818 171723
44 8 011818 171730	45 8 011818 171747	46 8 011818 171754
47 8 011818 171761		



38 - 47



Stivaletto anfibio in poliuretano – Imbottito in agnello acrilico. Senza puntale e lamina.

**Applicazione:** agricoltura/giardinaggio, tempo libero

**Taglie :** 38/47

**Imballo minimo per ordine:** 1 paio

**Volume scatola:** 0,16 m3 - 6 paia kg. 9

**Articolo dotato di codice a barre.**



## art. 26



Stivale color arancio con puntale e lamina in acciaio Suola carrarmato antiscivolo.

**Applicazione:** industria, cantieri e lavori edili (-40° C.)

**Taglie:** 38/47

**Imballo minimo per ordine:** 1 paio

**Volume scatola:** 0,16 m3 - 6 paia kg. 11

**Articolo dotato di codice a barre.**



[EN ISO 20345 S5 SRC]

PU



38 - 47



-40°C



## art. 25



Stivale in poliuretano bianco.

Suola carrarmato antiscivolo.

**Applicazione:** industria alimentare, basse temperature (-40°C.)

**Taglie:** 38/47

**Imballo minimo per ordine:** 1 paio

**Volume scatola:** 0,16 m3 - 6 paia kg. 9

**Articolo dotato di codice a barre.**



[EN ISO 20345 S4 SRC]

PU



38 - 47



-40°C



## art. 19BCE

[EN ISO 20345 S4 SRA]

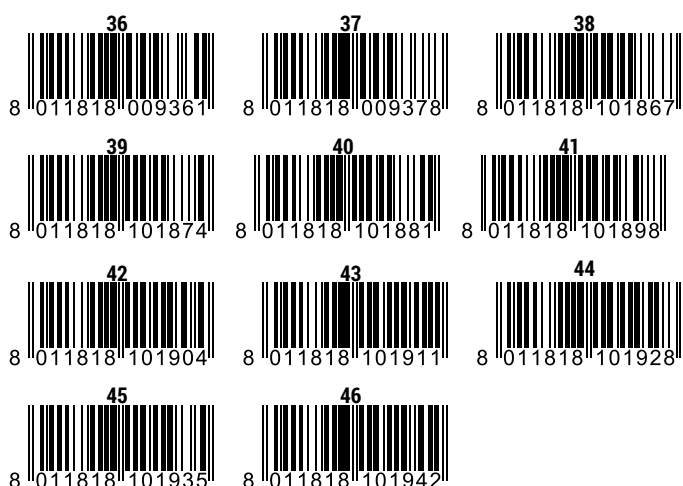

Stivale al ginocchio in gomma nitrilica bianca, suola grigia antiscivolo, con puntale in acciaio, resistente ai grassi animali, oli, acidi, antistatica.

**Taglie:** 36/46

**Applicazione:** alimentare, farmaceutica, caseario, macelli

**Packing:** 1 paio

**Imballo minimo per ordine:** 1 paio

**Scatola:** 6 paia - volume m<sup>3</sup> 0,15 - peso Kg. 10

**Articolo dotato di codice a barre**



NITRILE



36 - 46



## art. 18ACE

[EN ISO 20347 SRA]

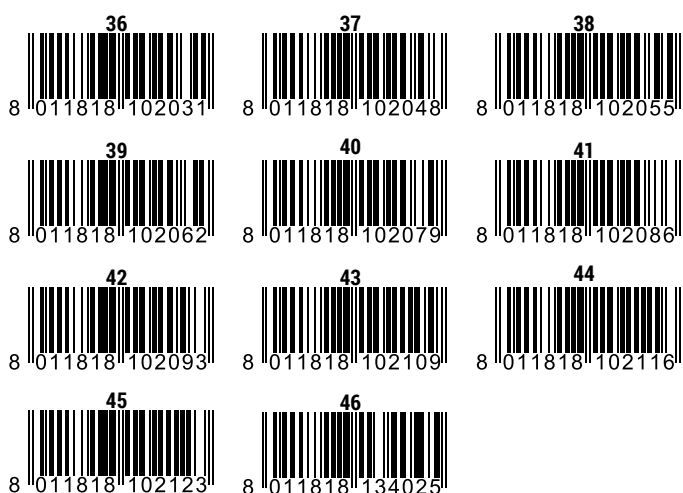

Stivale al ginocchio in gomma nitrilica bianca, senza puntale.

Suola grigia antiscivolo resistente ai grassi animali, oli e acidi, antistatica.

**Taglie:** 36/46

**Applicazione:** settore alimentare

**Packing:** 1 paio

**Imballo minimo per ordine:** 6 paia per misura

**Scatola:** 6 paia - volume m<sup>3</sup> 0,15 - peso Kg. 9

**Articolo dotato di codice a barre**



NITRILE



36 - 46



## art. 24



-40°C



[EN ISO 20345 S5 SRC]

PU



38 - 47



-40°C



Stivale in poliuretano verde con puntale e lamina in acciaio. Suola carrarmato antiscivolo.

**APPLICAZIONE:** agricoltura/giardinaggio, cantieri e lavori edili (-40° C.)

**Taglie:** 38/47

**Imballo minimo per ordine:** 1 paio

**Volume scatola:** 0,16 m<sup>3</sup> - 6 paia kg. 11

**Articolo dotato di codice a barre.**



CE

## art. 10CE



[EN ISO 20345 - S5 SRA]

PVC



37 - 48

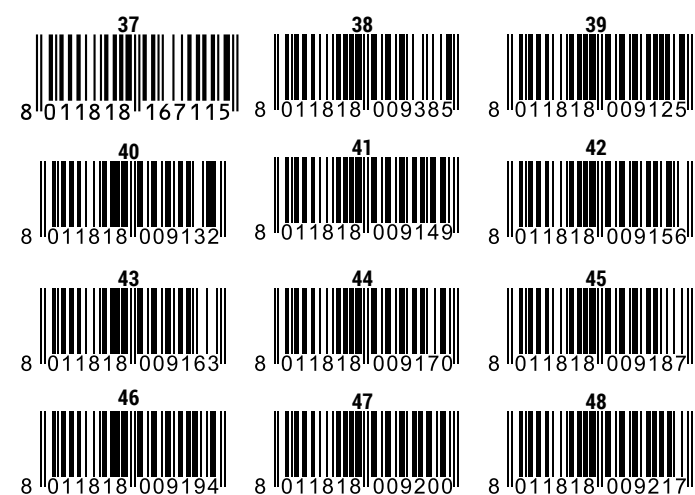

Stivale in PVC con puntale e lamina in acciaio. Suola antiscivolo, antiolio, antiacido, antistatica. Indicato nel settore edile, agricoltura e petrolchimico

**Taglie:** 37/48

**Applicazione:** Edilizia - petrolchimica

**Packing:** 1 paio

**Imballo minimo per ordine:** 6 paia per misura

**Scatola:** 6 paia - volume m<sup>3</sup> 0,15 - peso Kg. 10

**Articolo dotato di codice a barre**



CE

## art. 10CE-V

[EN ISO 20345 - S5 SRA]



38 8 011818 107883	39 8 011818 107890	40 8 011818 107906
41 8 011818 107913	42 8 011818 107920	43 8 011818 107937
44 8 011818 107944	45 8 011818 107951	46 8 011818 107968
47 8 011818 107975		

Stivale in PVC con puntale e lamina in acciaio. Suola antiscivolo, antiolio, antiacido, antistatica. Indicato nel settore edile, agricoltura e petrolchimico

**Taglie:** 38/47

**Applicazione:** edilizia, agricoltura, petrolchimica

**Packing:** 1 paio

**Imballo minimo per ordine:** 6 paia per misura

**Scatola:** 6 paia - volume m<sup>3</sup> 0,15 - peso Kg. 10

**Articolo dotato di codice a barre**



PVC



38 - 47



## art. 12CE

[EN ISO 20347 SRA]

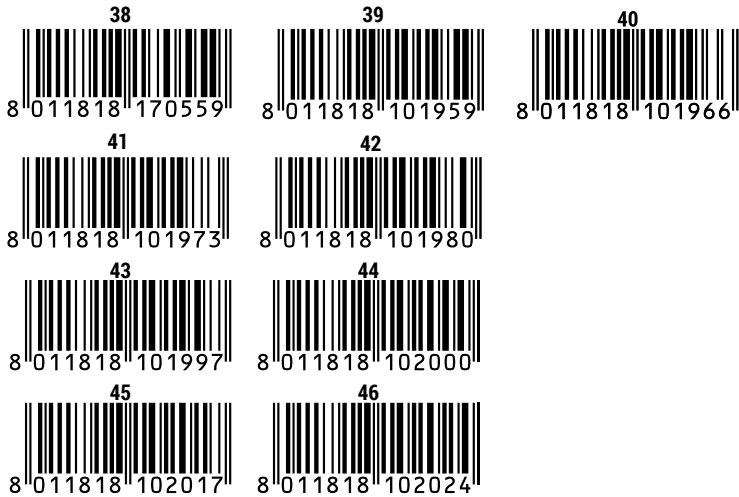

Stivale polygum al ginocchio, color marrone.  
Suola carrarmato.

**Applicazione:** agricoltura/giardinaggio, industria,  
industria chimica-farmaceutica

**Taglie :** 38/46

**Imballo minimo per ordine:** 1 paio

**Volume scatola:** 0,16 m3 - 6 paia kg. 6

**Articolo dotato di codice a barre.**



POLYGUM



38 - 46



## art. 12BCE

[EN ISO 20347 SRA]

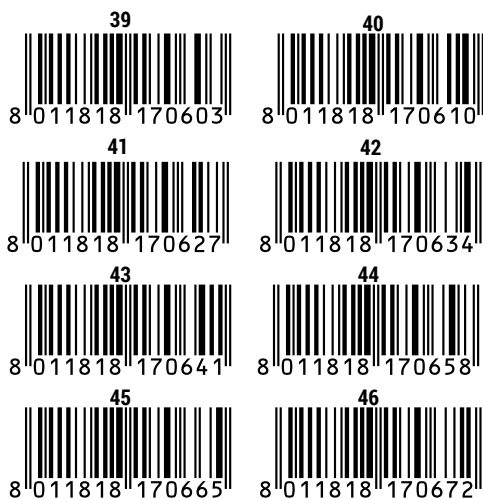

Stivale polygum tronchetto, color marrone.  
Suola carrarmato.

**Applicazione:** agricoltura/giardinaggio, industria,  
industria chimica-farmaceutica

**Taglie :** 39/46

**Imballo minimo per ordine:** 1 paio

**Volume scatola:** 0,16 m3 - 6 paia kg. 9

**Articolo dotato di codice a barre.**



POLYGUM



39 - 46



## art. 10ACE

[EN ISO 20347 - SRA]



36 8 011818 107982	37 8 011818 107999	38 8 011818 108002
39 8 011818 101706	40 8 011818 101713	41 8 011818 101720
42 8 011818 101737	43 8 011818 101744	44 8 011818 101751
45 8 011818 101768	46 8 011818 101775	47 8 011818 115291

Stivali al ginocchio in pvc, suola carrarmato.

**Taglie:** 36/47**Applicazione:** agricoltura, edilizia**Packing:** 1 paio in sacchetto**Imballo minimo per ordine:** 6 paia**Scatola:** 6 paia - volume m<sup>3</sup> 0,10 - peso Kg. 9**Articolo dotato di codice a barre**

PVC



36 - 47

CE

## art. 10BCE

[EN ISO 20347 - SRA]



36 8 011818 108019	37 8 011818 108026	38 8 011818 108033
39 8 011818 101782	40 8 011818 101799	41 8 011818 101805
42 8 011818 101812	43 8 011818 101829	44 8 011818 101836
45 8 011818 101843	46 8 011818 101850	47 8 011818 135756

Stivali tronchetto in pvc. Suola carrarmato

**Taglie:** 36/47**Applicazione:** agricoltura - edilizia**Packing:** 1 paio in sacchetto**Imballo minimo per ordine:** 6 paia**Scatola:** 6 paia - volume m<sup>3</sup> 0,10 - peso Kg. 9**Articolo dotato di codice a barre**

PVC



36 - 47

CE

## art. 11R

[EN ISO 20347 - SRA]



Stivale al ginocchio in gomma con suola carrarmato

**Taglie:** 39/47

**Applicazione:** agricoltura, edilizia

**Packing:** 1 paio in scatola singola

**Imballo minimo per ordine:** 5 paia

**Scatola:** 5 paia - volume m<sup>3</sup> 0,08 - peso Kg. 8

**Articolo dotato di codice a barre**



**GOMMA  
RUBBER**



39 - 47

CE

## art. 11AR

[EN ISO 20347 - SRA]

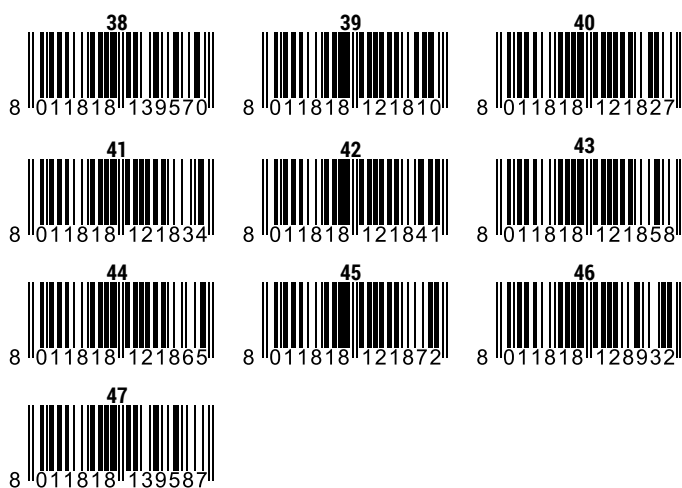

Stivale al tronchetto in gomma con suola carrarmato

**Taglie:** 38/47

**Applicazione:** agricoltura, edilizia

**Packing:** 1 paio in scatola singola

**Imballo minimo per ordine:** 5 paia

**Scatola:** 5 paia - volume m<sup>3</sup> 0,08 - peso Kg. 8

**Articolo dotato di codice a barre**



**GOMMA  
RUBBER**



38 - 47

CE



## art. 11

[EN ISO 20347 - SRA]



Stivale al ginocchio in gomma con suola calandrata

**Taglie:** 39/47**Applicazione:** agricoltura**Packing:** 1 paio in scatola singola**Imballo minimo per ordine:** 5 paia**Scatola:** 5 paia - volume m<sup>3</sup> 0,08 - peso Kg. 8**Articolo dotato di codice a barre****GOMMA  
RUBBER**

39 - 47



## art. 11A

[EN ISO 20347 - SRA]

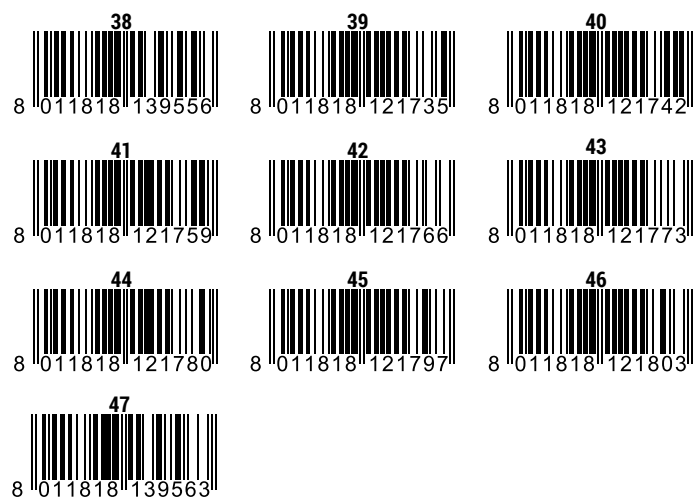

Stivale al tronchetto in gomma con suola calandrata

**Taglie:** 38/47**Applicazione:** agricoltura**Packing:** 1 paio in scatola singola**Imballo minimo per ordine:** 5 paia**Scatola:** 5 paia - volume m<sup>3</sup> 0,08 - peso Kg. 8**Articolo dotato di codice a barre****GOMMA  
RUBBER**

38 - 47



## art. 11RV

[EN ISO 20347 - SRA]



38 8 011818 152906	39 8 011818 152913	40 8 011818 152920
41 8 011818 152937	42 8 011818 152944	43 8 011818 152951
44 8 011818 152968	45 8 011818 152975	46 8 011818 152982
47 8 011818 152999		

Stivale verde al ginocchio in gomma con suola carrarmato

**Taglia:** 38-47

**Applicazione:** agricoltura

**Packing:** scatola da 1 paio

**Imballo minimo per ordine:** 5 paia

**Scatola:** 5 paia volume m<sup>3</sup> 0,10 Kg.10

**Articolo dotato di codice a barre**



**GOMMA  
RUBBER**



38 - 47



## art. 11ARV

[EN ISO 20347 - SRA]



39 8 011818 152531	40 8 011818 152548	41 8 011818 152555
42 8 011818 152562	43 8 011818 152579	44 8 011818 152586
45 8 011818 152593	46 8 011818 152609	47 8 011818 152890

Stivale verde al tronchetto in gomma con suola carrarmato

**Taglia:** 39-47

**Applicazione:** agricoltura

**Packing:** scatola da 1 paio

**Imballo minimo per ordine:** 5 paia

**Scatola:** 5 paia volume m<sup>3</sup> 0,10 Kg.10

**Articolo dotato di codice a barre**



**GOMMA  
RUBBER**



39 - 47



## art. 11V

[EN ISO 20347 - SRA]

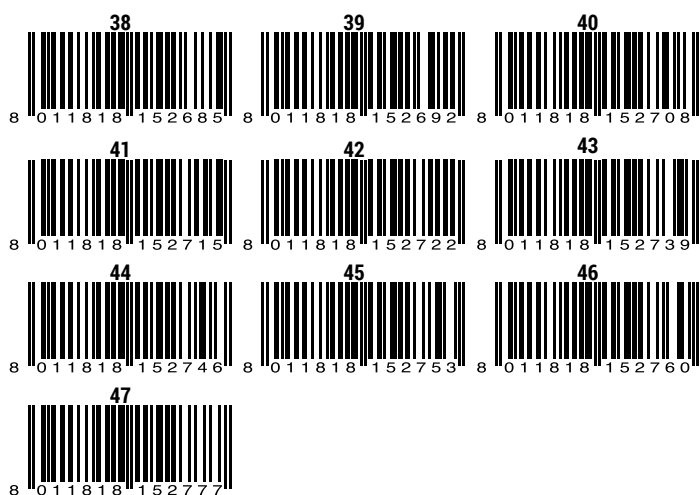

Stivale verde al ginocchio in gomma con suola calandrata

**Taglia:** 38-47

**Applicazione:** agricoltura

**Packing:** scatola da 1 paio

**Imballo minimo per ordine:** 5 paia

**Scatola:** 5 paia volume m<sup>3</sup> 0,10 Kg.10

**Articolo dotato di codice a barre**



**GOMMA  
RUBBER**



38 - 47



## art. 11AV

[EN ISO 20347 - SRA]

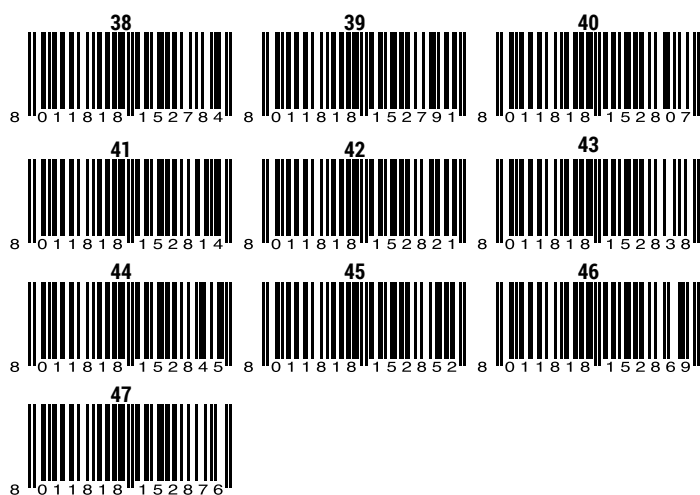

Stivale verde al tronchetto in gomma con suola calandrata

**Taglia:** 38-47

**Applicazione:** agricoltura

**Packing:** scatola da 1 paio

**Imballo minimo per ordine:** 5 paia

**Scatola:** 5 paia volume m<sup>3</sup> 0,10 Kg.10

**Articolo dotato di codice a barre**



**GOMMA  
RUBBER**



38 - 47



## art. 10D

[EN ISO 20347 - SRA]

**GOMMA  
RUBBER**

38 - 47

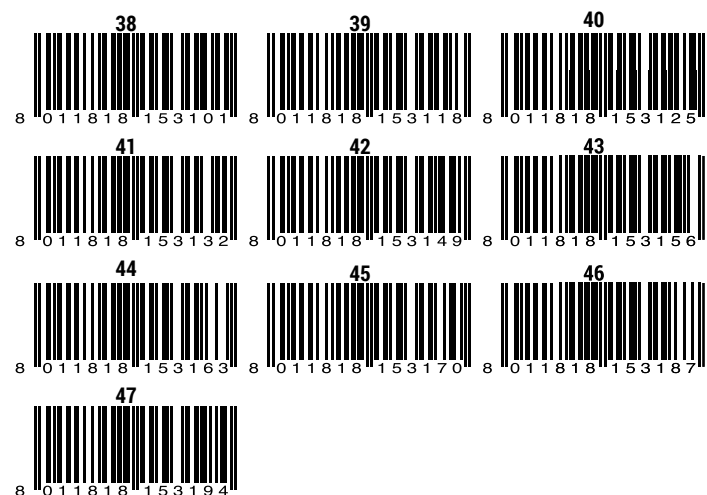

Stivale in gomma a coscia color verde

**Taglia:** 38-47

**Applicazione:** agricoltura

**Packing:** sacchetto da 1 paio

**Imballo minimo per ordine:** 1 paio

**Scatola:** 5 paia volume m<sup>3</sup> 0,10 Kg.10

**Articolo dotato di codice a barre**



## art. 579CE

[EN ISO 20345 - S3]



39 - 47



Stivale in pelle nabuck S3 idrorepellente, con puntale in acciaio a pianta larga e sottopiede tessile antiforo. Suola in poliuretano antiscivolo, antiolio, antiacido, antistatica. Soletta interna antibatterica ed anatomica.

Foderato internamente in pelliccia.

**Applicazioni:** edilizia, industria, agricoltura

**Volume scatola:** 0,08 m<sup>3</sup> (5 paia) - Peso: Kg. 8

**Articolo dotato di codice a barre.**



art. 3A

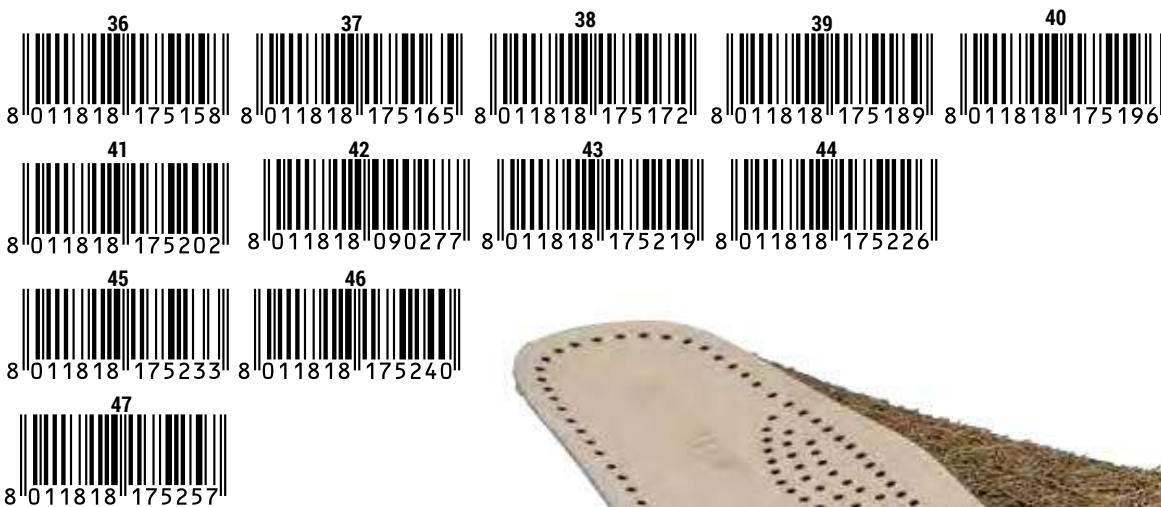

Sottopiede in cuoio e fibra di cocco - EXTRA COMFORT  
**Taglie:** 36/47  
**Packaging:** 12 paia  
**Imballo minimo per ordine:** 12 paia  
**Volume scatola:** 0,03 m<sup>3</sup> (12 paia) **Peso kg.** 1,5  
**Articolo dotato di codice a barre.**



  
36 - 47

art. 3D

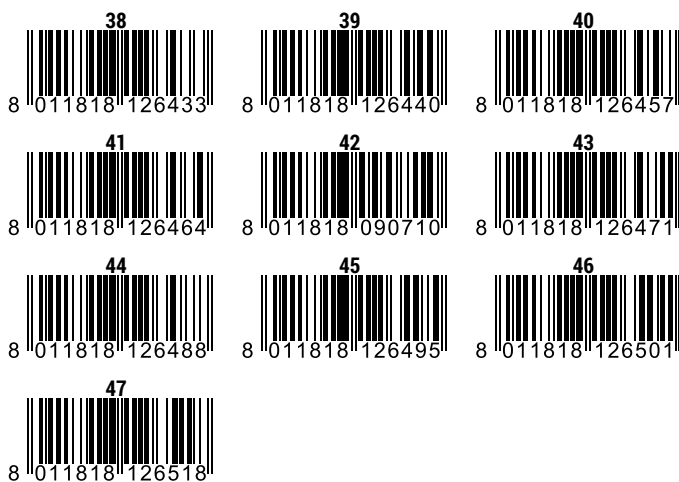

Sottopiede in cuoio antistatico  
**Taglie:** 38/47  
**Packing:** 12 paia  
**Imballo minimo per ordine:** 12 paia  
**Scatola:** 12 paia - volume m<sup>3</sup> 0,03 - **Peso Kg.** 2  
**Articolo dotato di codice a barre**



  
38 - 47

## art. 3E



Sottopiede in cuoio antistatico aerato

**Taglie:** 39/47

**Packing:** 12 paia

**Imballo minimo per ordine:** 12 paia

**Scatola:** 12 paia - volume m<sup>3</sup>0,03 - Peso Kg. 2

**Articolo dotato di codice a barre**



## art. 3H



Sottopiede in polimeri antisudore areato

**Taglie:** 37/46

**Packing:** 12 paia

**Imballo minimo per ordine:** 12 paia

**Scatola:** 12 paia - volume m<sup>3</sup>0,03 - Peso Kg. 1,5

**Articolo dotato di codice a barre**

## art. 3C



Sottopiede antifreddo in feltro

**Taglie:** UNICA

**Packing:** 12 paia

**Imballo minimo per ordine:** 12 paia

**Scatola:** 12 paia - volume m<sup>3</sup>0,03 - Peso Kg. 2

**Articolo dotato di codice a barre**

### art. 056



Calza lunga antibatterica, antiabrasione, antitaglio  
65% cotone, 29% nylon, 3% lycra, 3% kevlar.

**Applicazione:** Industria, Magazzini, Cantieri, Lavori Edili, Tempo Libero.

**Taglie:** M/XL

**Imballo minimo per ordine:** 3 paia

**Volume scatola:** 0,10 m3 - 24 paia kg. 6

**Articolo dotato di codice a barre e confezione appendibile**



### art. 057



Calza lunga antibatterica, traspirante, termoregolante 35% lana, 30% acrilico, 20% cotone, 12% nylon, 3% lycra.

**Applicazione:** Industria, Magazzini, Cantieri, Lavori Edili, Tempo Libero

**Taglie:** S/XL

**Imballo minimo per ordine:** 3 paia

**Volume scatola:** 0,10 m3 - 24 paia kg. 6

**Articolo dotato di codice a barre e confezione appendibile**



### art. 058



Calza corta antibatterica  
80% cotone 20% sintetico

**Taglie:** S M L XL XXL

**Applicazione:** industria, magazzini, cantieri e lavori edili, tempo libero.

**Imballo minimo per ordine:** 3 paia

**Volume scatola:** 0,08 m3 - 120 pezzi - peso kg. 8,5

**Articolo dotato di codice a barre.**



### art. 055



Calza in misto lana e fibra d'acciaio BEKINOX antistatica extra-resistente. 40% lana 30% poliammide 27% poliestere 3% bekinox

**Taglie:** M-L - **Packing:** 3 paia per taglia.

**Imballo minimo per ordine:** 3 paia per taglia.

**Scatola:** 30 paia - volume m<sup>3</sup>0,08 - Peso kg. 8

**Articolo dotato di codice a barre**





## art. 048



Calza invisibile estiva in cotone 80% poliammide 20% bianca.

**Taglie:** M-L - **Packing:** 3 paia per taglia.

**Imballo minimo per ordine:** 3 paia per taglia.

**Scatola:** 30 paia - volume m<sup>3</sup>0,10 - Peso kg. 5

**Articolo dotato di codice a barre**



## art. 049



Calza invisibile estiva in cotone 80% poliammide 20% nera.

**Taglie:** M-L - **Packing:** 3 paia per taglia.

**Imballo minimo per ordine:** 3 paia per taglia.

**Scatola:** 30 paia - volume m<sup>3</sup>0,10 - Peso kg. 5

**Articolo dotato di codice a barre**



## art. 3-I



Calzerotto antifreddo per calzature e stivali

**Taglie:** S- XXL - **Packing:** 6 paia per taglia.

**Imballo minimo per ordine:** 6 paia per taglia.

**Scatola:** 30 paia - volume m<sup>3</sup>0,10 - Peso kg. 5

**Articolo dotato di codice a barre**



## art. 012



Calzerotto in acrilico per stivali

**Taglie:** UNICA

**Packing:** 10 paia

**Imballo minimo per ordine:** 10 paia

**Scatola:** 100 paia - volume m<sup>3</sup>0,15- Peso kg. 10

**Articolo dotato di codice a barre**



# INDICE

**ARTICOLI PER OPERATORI  
FORESTALI CON USO DI MOTOSEGA**  
..... pag. 250

**ARTICOLI PER IMBIANCHINI E  
OPERATORI SMALTIMENTO AMIANTO**  
..... pag. 254

**ARTICOLI PER SALDATORI**  
..... pag. 264

**ARTICOLI SETTORE ALIMENTARE  
E MACELLI**  
..... pag. 276



SEBA



**OPERAI  
FORESTALI**



**IMBIANCHINI**



**SALDATORI**

art. 402



art. 401





## art. 401

CE

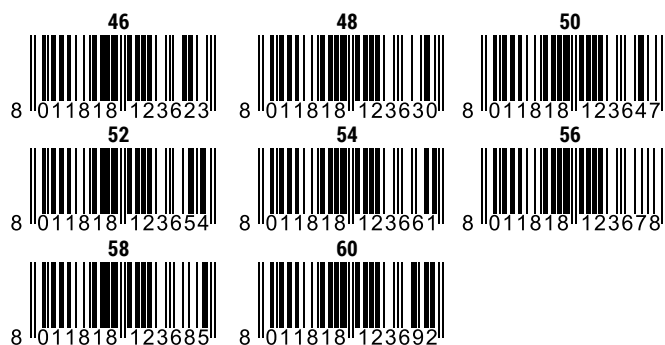

Pantaloni antitaglio con pettorina in cotone per forestali e operatori con motosega

**Taglie:** 46/60 - **Tessuto:** Poliestere/cotone peso gr 250 m<sup>2</sup>

**Applicazione:** forestale, agricoltura

**Packing:** in busta da 1 pezzo

**Imballo minimo per ordine:** 1 pezzo

**Scatola:** 10 pezzi per taglia - volume m<sup>3</sup> 0,08 - peso kg 9

**Articolo dotato di codice a barre**



46 - 60

## art. 402

CE



Giacca per forestali non imbottita (senza protezione)

**Taglie:** M/XL

**Tessuto:** Poliestere/cotone peso gr 250 m<sup>2</sup>

**Applicazione:** forestale, agricoltura

**Packing:** in busta da 1 pezzo

**Imballo minimo per ordine:** 1 pezzo

**Scatola:** 10 pezzi per taglia - volume m<sup>3</sup> 0,08 - peso kg 8

**Articolo dotato di codice a barre**



M - XL

## art. 402P

CE



Giacca per forestali con protezione spalle e braccia

**Taglie:** M/XXL

**Tessuto:** Poliestere/cotone rinforzato peso gr 250 m<sup>2</sup>

**Applicazione:** forestale, agricoltura

**Packing:** in busta da 1 pezzo

**Imballo minimo per ordine:** 1 pezzo

**Scatola:** 10 pezzi per taglia - volume m<sup>3</sup> 0,08 - peso kg 9

**Articolo dotato di codice a barre**



M - XXL

## art. 406



3132



Manicotti anti-motosega per uso forestale

**Taglia:** unica

**Tessuto:** Poliestere/cotone

**Applicazione:** forestale, agricoltura

**Packing:** in busta da 1 paio

**Imballo minimo per ordine:** 1 paio

**Scatola:** 10 pezzi per taglia - volume m<sup>3</sup> 0,05 - peso kg 6

**Articolo dotato di codice a barre**



UNICA

## art. 407L

[EN420:5 - EN388:3132 - EN381-7 classe 0]



Guanti in fiore per motosega con manicotto in crosta cm 10

**Taglia:** 8 - 10

**Tessuto:** Poliestere/cotone

**Applicazione:** forestale, agricoltura

**Packing:** in busta da 1 paio

**Imballo minimo per ordine:** 1 paio

**Scatola:** 10 pezzi per taglia - volume m<sup>3</sup> 0,05 - peso kg 4

**Articolo dotato di codice a barre**



8 - 10

## art. 403

[EN ISO 20345 + EN ISO 17249- 2 CLASSE II]



Stivale per motoseghisti con puntale e lamina in acciaio (24 mt. al secondo). Tomaio in gomma completo di protezione al metatarso. Suola in gomma antiscivolo

**Taglie:** 39/47

**Packing:** 1 paio

**Imballo minimo per ordine:** 1 paio

**Scatola:** 1 paio - volume m<sup>3</sup> 0,05 - peso Kg. 2,5

**Articolo dotato di codice a barre**



39 - 47

art. 404CE

[EN ISO 20345 - S3 HRO]



39 - 45

**STIVALETTO PELLE S3 HRO ACQUASTOP**  
 Stivaletto ACQUASTOP per motoseghisti con puntale e lamina in acciaio. Tomaio in pelle vitello anfibio idrorepellente. Suola con particolare mescola anticalore, antiscivolo, antiolio, antiacido, antistatica. Membrana interna VERATEX impermeabile e traspirante

**Taglie:** 39/45

**Imballo minimo per ordine:** 1 paio

**Volume scatola:** m<sup>3</sup> 0,15 (6 paia) - peso kg 12

**Articolo dotato di codice a barre**

art. 430

[EN397 - EN352]



Casco di sicurezza completo di cuffie e rete

**Applicazione:** Edilizia - Forestale

**Packing:** 1 pz.

**Imballo minimo per ordine:** 1 pz.

**Scatola:** 1 pz. - volume m<sup>3</sup> 0,03 - peso kg. 1

**Articolo dotato di codice a barre**

art. 408



8 011818 167146



Filo decespugliatore in nylon  
**FILO TONDO mm 2,40 x15 mt. in box**

art. 409



8 011818 167153



Filo decespugliatore in nylon  
**FILO TONDO mm 3 x15 mt. in box**

art. 410



8 011818 167160



Filo decespugliatore in nylon  
**FILO QUADRO mm 2,40 x15 mt. in box**

art. 411



8 011818 167177



Filo decespugliatore in nylon  
**FILO QUADRO mm 3 x15 mt. in box**





IMBIANCHINI



SMALTIMENTO  
AMIANTO



art. 460BV

[CE - Cat.1]

art. 460BVF

[CE - Cat.1]



Giubbotto bicolore in poliestere 65% / cotone 35%, peso gr. 180/m<sup>2</sup>

**Taglie:** M-L-XL-XXL-XXXL

**Tessuto:** poliestere/cotone

**Applicazione:** imbianchini, edilizia, magazzini

**Packing:** 1 pezzo

**Imballo minimo per ordine:** 1 pezzo

**Scatola:** 10 pezzi per taglia - volume m<sup>3</sup> 0,10 - peso kg 8

**Articolo dotato di codice a barre e confezione appendibile**



Giubbotto imbottito bicolore in poliestere 65% / cotone 35%, peso gr. 245/m<sup>2</sup>

**Taglie:** S-M-L-XL-XXL-XXXL

**Tessuto:** poliestere/cotone

**Imbottitura:** 100% poliestere gr. 120/m<sup>2</sup> con fodera in nylon 190T trapuntato

**Applicazione:** imbianchini, edilizia, magazzini

**Packing:** 1 pezzo

**Imballo minimo per ordine:** 1 pezzo

**Scatola:** 10 pezzi per taglia - volume m<sup>3</sup> 0,12 - peso kg 10

**Articolo dotato di codice a barre e confezione appendibile**

art. 461BV

[CE - Cat.1]

art. 458BV

[CE - Cat.1]



Pantalone bicolore in poliestere 65% / cotone 35%, peso gr. 180/m<sup>2</sup> - con tasca porta ginocchiera. elastico in vita regolabile.

**Taglie:** M-L-XL-XXL-XXXL

**Tessuto:** poliestere/cotone

**Applicazione:** imbianchini, edilizia, magazzini

**Packing:** 1 pezzo

**Imballo minimo per ordine:** 1 pezzo

**Scatola:** 10 pezzi per taglia - volume m<sup>3</sup> 0,10 - peso kg 8

**Articolo dotato di codice a barre e confezione appendibile**



M-XXXL



Pettorina multitasche bicolore in poliestere 65% / cotone 35%, peso gr. 180/m<sup>2</sup> - con tasca portaginocchiera. elastico in vita regolabile.

**Taglie:** S-M-L-XL-XXL-XXXL

**Tessuto:** poliestere/cotone

**Applicazione:** imbianchini, edilizia, magazzini

**Packing:** 1 pezzo

**Imballo minimo per ordine:** 1 pezzo

**Scatola:** 10 pezzi per taglia - volume m<sup>3</sup> 0,10 - peso kg 9

**Articolo dotato di codice a barre e confezione appendibile**



S-XXXL

art. 112

[CE - Cat.1]



Tuta in polipropilene usa e getta con cappuccio - prima categoria.

**Taglie:** M-L-XL-XXL

**Materiale:** polipropilene peso gr 40 m<sup>2</sup>

**Applicazione:** industria, agricoltura, edilizia, pulizia

**Packing:** in busta da 1 pezzo

**Imballo minimo per ordine:** 25 pezzi per taglia e/o multipli

**Scatola:** 25 pezzi per taglia - volume m<sup>3</sup> 0,08 - peso kg 7

**Articolo dotato di codice a barre**



art. 120C

[EN13034 - 13982-1

TYPE 5 - 6 EN 1149]



Tuta usa e getta tipo antistatica e traspirante (per schizzi leggeri)

**Taglie:** M-L-XL-XXL

**Tessuto:** Polipropilene trasperante.

**Applicazione:** industria, agricoltura, edilizia

**Packing:** in busta da 1 pezzo

**Imballo minimo per ordine:** 25 pezzi per taglia e/o multipli

**Scatola:** 25 pezzi per taglia - volume m<sup>3</sup> 0,08 - peso kg 8

**Articolo dotato di codice a barre**



art. 4610SB

[CE - Cat.1]

art. 461BI

[CE - Cat.1]



Pantalone in cotone, ospedaliero e alimentare, con tasche - bianco

**Taglie:** M-L-XL-XXL

**Tessuto:** 100% cotone peso gr 200 m<sup>2</sup>

**Applicazione:** settore alimentare, ospedaliero, edilizia

**Packing:** in busta da 1 pezzo

**Imballo minimo per ordine:** 1 pezzo

**Scatola:** 20 pezzi per taglia - volume m<sup>3</sup> 0,10 - peso kg 8

**Articolo dotato di codice a barre**



Pantaloni uomo in cotone 100% - gr 250 m<sup>2</sup> con portametro.

**Taglia:** 44-60

**Applicazione:** alimentare, edilizia

**Packing:** 1 busta da 1 pezzo

**Imballo minimo per ordine:** 5 pezzi per taglia e/o multipli

**Scatola:** 20 pezzi - volume m<sup>3</sup> 0,10 Kg.9

**Articolo dotato di codice a barre**



art. 463



S - XXL

T-shirt bianca in cotone – collo largo, doppio a 4 rib

**Taglie:** S-M-L-XL-XXL

**Tessuto:** 100% cotone peso gr 130 m<sup>2</sup>

**Applicazione:** industria, edilizia, agricoltura, tempo libero.

**Packing:** in busta da 12 pezzi ripiegati in due

**Imballo minimo per ordine:** 12 pezzi per taglia e/o multipli

**Scatola:** 120 pezzi per taglia - volume m<sup>3</sup> 0,10 - peso kg 14

**Articolo dotato di codice a barre**

art. 466BI



S - XXL

Polo piquet in cotone a manica corta

**Taglie:** S - M-L-XL-XXL

**Tessuto:** 100% cotone peso gr 180 m<sup>2</sup>

**Applicazione:** industria, edilizia, agricoltura, tempo libero.

**Packing:** in busta da 1 pezzo

**Imballo minimo per ordine:** 5 pezzi per taglia e/o multipli

**Scatola:** 25 pezzi per taglia - volume m<sup>3</sup> 0,08 - peso kg 9

**Articolo dotato di codice a barre**

## art. 103TG



Tuta ginnica grigia in cotone/poliestere.

**Taglie:** M-L-XL-XXL

**Tessuto:** poliestere/cotone

**Applicazione:** magazzini, tempo libero, imbianchini

**Packing:** in busta da 1 pezzo

**Imballo minimo per ordine:** 1 pezzo

**Scatola:** 15 pezzi per taglia - volume m<sup>3</sup> 0,10 - peso kg 9

**Articolo dotato di codice a barre**



M-XXL

## art. 60A

[EN374 EN388 1011]



1011



Guanto in neoprene bicolore - cm 32

Spessore 0,50 mm

**Taglie:** 7 - 8 - 9 - 10

**Applicazione:** industria - chimica - edilizia

**Packing:** 10 paia

**Imballo minimo per ordine:** 100 paia

**Scatola:** 100 paia - volume m<sup>3</sup> 0,09 - peso Kg. 9

**Articolo dotato di codice a barre e busta appendibile**



7 - 10

## art. 500BO-ECO

[EN388 3131]



XS (6)



S (7)



M (8)



L (9)



XL (10)



XXL (11)



Guanto in poliuretano bianco spalmato su nylon.

Lavabile a 40°C con detergente neutro.

**Taglie:** 6 - 11 **Applicazione:** imbianchini

**Packing:** 12 paia

**Imballo minimo per ordine:** 240 paia

**Scatola:** 240 paia volume m<sup>3</sup> 0,10 Kg.10

**Articolo dotato di codice a barre e busta appendibile.**



6 - 11

art. 624SLNMCE

[EN ISO 20345 - S3 - SRC]



36 8 011818 162813	37 8 011818 162820	38 8 011818 162837
39 8 011818 162844	40 8 011818 162851	41 8 011818 162868
42 8 011818 162875	43 8 011818 162882	44 8 011818 162899
45 8 011818 162905	46 8 011818 162912	47 8 011818 162929

Calzatura bassa con puntale in composito e soletta tessile antiforo. Tomaia in MICROFIBRA traspirante. Suola in gomma nitrilica trasparente antistatica, antiscivolo, anticalore, antiacido.  
**Peso:** gr. 430 nella taglia 42  
**Applicazione:** settore alimentare - imbianchini.  
**Taglie :** 36/47  
**Imballo minimo per ordine:** 1 paio  
**Volume scatola:** 0,16 m3 - 6 paia kg. 9  
**Articolo dotato di codice a barre.**



36 - 47

art. 625NMCE

[EN ISO 20345 - S2 - SRC]



36 8 011818 163094	37 8 011818 163100	38 8 011818 163117
39 8 011818 163124	40 8 011818 163131	41 8 011818 163148
42 8 011818 163155	43 8 011818 163162	44 8 011818 163179
45 8 011818 163186	46 8 011818 163193	47 8 011818 163209

Sandalo con puntale in composito  
 Tomaia in MICROFIBRA traspirante.  
 Suola in gomma nitrilica trasparente antistatica, antiscivolo, anticalore, antiacido.  
**Peso:** gr. 430 nella taglia 42  
**Applicazione:** settore alimentare - imbianchini.  
**Taglie :** 36/47  
**Imballo minimo per ordine:** 1 paio  
**Volume scatola:** 0,16 m3 - 6 paia kg. 9  
**Articolo dotato di codice a barre.**



36 - 47

art. 120D



[Cat. 3 TYPE 5 (EN13982 - 1 : 2004)  
TYPE 6 (EN13034 : 2005) EN1149]

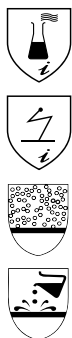

Tuta cucita e ribattuta antistatica e traspirante (per schizzi pericolosi)  
3° categoria

**Taglie:** M-L-XL-XXL-XXXL - **Tessuto:** SMMS ®

**Applicazione:** industria, agricoltura, edilizia, chimica

**Packing:** in busta da 1 pezzo

**Imballo minimo per ordine:** 25 pezzi per taglia e/o multipli

**Scatola:** 25 pezzi per taglia - volume m<sup>3</sup> 0,08 - peso kg 8

**Articolo dotato di codice a barre**





[Cat. 3EN14605:2005 - TYPE 4  
EN ISO 13982-1:2004 TYPE 5  
EN 13034:2005 TYPE6]

art. 120DTS

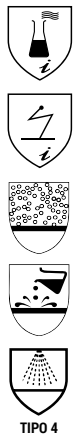

TIPO 4



M



L



XL



XXL



XXXL

Tuta cucita e termosaldata antistatica e traspirante ( per schizzi pericolosi) 3a categoria. Con cappuccio , lestico ai polsi e caviglie - zip centrale e due mandate.

**Taglie:** M-L-XL-XXL-XXXL

**Tessuto:** SMMS

**Applicazione:** industria, agricoltura, edilizia, chimica, smaltimento amianto.

**Packing:** in busta da 1 pezzo.

**Imballo minimo per ordine :** 25 pezzi per taglia e/o multipli

**Scatola :** 25 pezzi per taglia - volume m<sup>3</sup> 0,08 - peso kg. 8

**Articolo dotato di codice a barre**



art. 500LT

[EN388 4544]



4544

12



8 - 10



8



9



10

Guanto lungo antitaglio in nylon 13G / fibra di vetro antitaglio LIVELLO 5, spalmatura rugosa in nitrile.

**Taglia:** 8-9-10

**Applicazione :** lavorazioni del vetro o in presenza di sbavature metalliche, meccanica, edilizia.

**Packing:** 12 paia - **Imballo minimo per ordine :** 60 paia

**Scatola:** 60 paia - volume m<sup>3</sup> 0,10 - peso kg. 9

**Articolo dotato di codice a barre.**

art. 4E

[(FFP3) EN 149:2001 + A1:2009]



8 011818 096002



Facciale filtrante, leggero e confortevole con elastici regolabili, con valvola di espirazione. Indicato per polveri molto fini, amianto, imbustata singolarmente.

**Applicazione:** industria - **Packing:** 5 pz

**Imballo minimo per ordine:** 60 pz.

**Scatola:** 60 pz. - volume m<sup>3</sup> 0,10. Peso Kg. 10

**Articolo dotato di codice a barre e confezione appendibile**



# ARTICOLI SALDATORI

## art. 5CE



[CE EN 470]



Giubbotto in crosta bovina per saldatori

**Taglie:** L - XL-XXL

**Applicazione:** edilizia - industria

**Packing:** in busta da 1 pezzo

**Imballo minimo per ordine:** 1 pezzo

**Scatola:** 10 pezzi per taglia - volume m<sup>3</sup> 0,10 - peso kg 15

**Articolo dotato di codice a barre**



L - XXL

## art. 7CE



[CE EN 470]

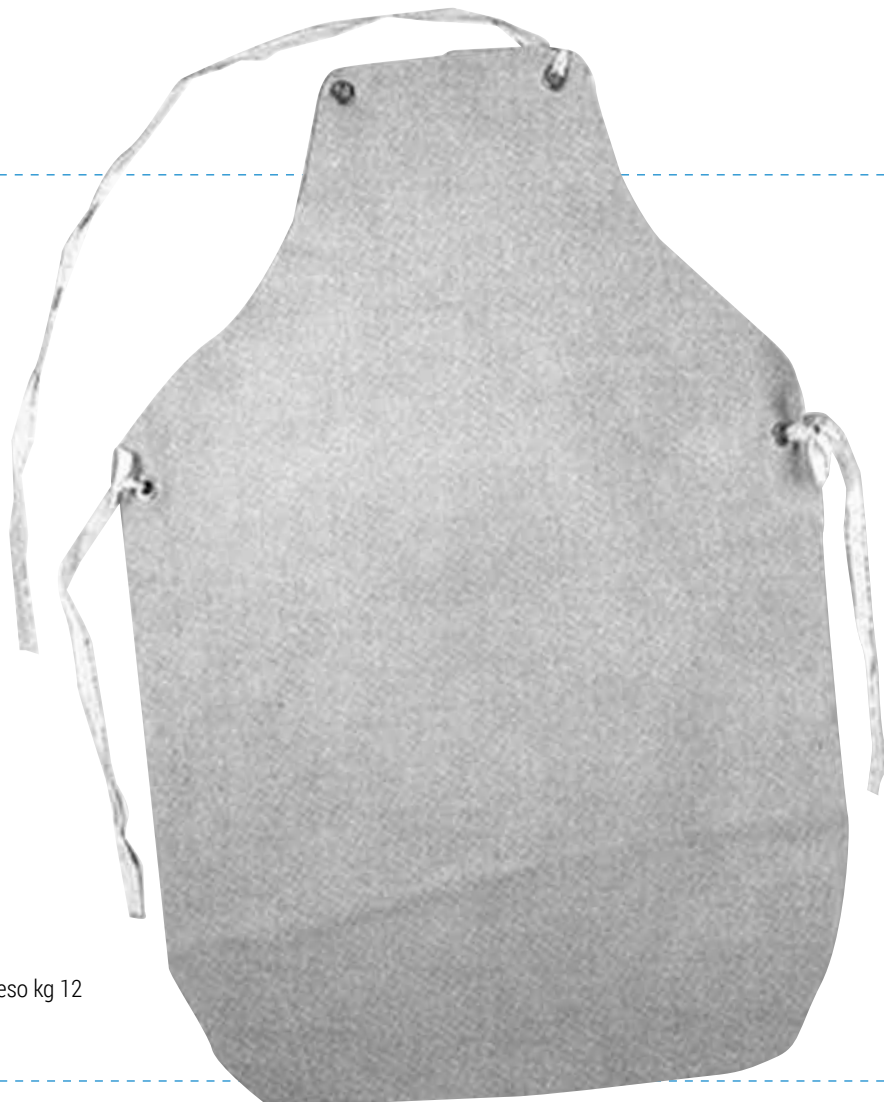

Grembiule in crosta bovina per saldatori

**Dimensione:** cm 90 x 60

**Applicazione:** edilizia - industria

**Packing:** 5 pezzi

**Imballo minimo per ordine:** 5 pezzi

**Scatola:** 20 pezzi per taglia - volume m<sup>3</sup> 0,10 - peso kg 12

**Articolo dotato di codice a barre**



UNICA

art. 7ACE

[CE EN 470]



8 011818 108187



Grembiule in crosta bovina per saldatori con rinforzo centrale

**Dimensione:** cm 90 x 60

**Applicazione:** edilizia - industria

**Packing:** 5 pezzi

**Imballo minimo per ordine:** 5 pezzi

**Scatola:** 20 pezzi per taglia - volume m<sup>3</sup> 0,10 - peso kg 12

**Articolo dotato di codice a barre**



UNICA

art. 14ACE

[CE EN 470]



8 011818 108170



Maniche in crosta per saldatori

**Applicazione:** edilizia - industria

**Packing:** 5 paia

**Imballo minimo per ordine:** 5 paia

**Scatola:** 10 paia - volume m<sup>3</sup> 0,10 - peso kg 8

**Articolo dotato di codice a barre**



UNICA

art. 13ACE

[CE EN 470]



8 011818 108163



Ghette in crosta per saldatori

**Applicazione:** edilizia - industria

**Packing:** in busta da 1 paio

**Imballo minimo per ordine:** 10 paia

**Scatola:** 10 paia - volume m<sup>3</sup> 0,10 - peso kg 8

**Articolo dotato di codice a barre**



UNICA

## art. 436S

[CE EN 470 EN531 EN533]

## art. 437S

[CE EN 470 EN531 EN533]



Tuta per saldatori - fiamma ritardante (cappuccio a parte: art.14C). Tuta indicata per saldatori e per operatori che svolgono mansioni a contatto con fiamma a propagazione limitata. La temperatura di lavaggio del capo non deve superare i 40°C.

**Taglie:** M-L-XL-XXL

**Tessuto:** 100% cotone trattato fiamma ritardante peso gr 220 m<sup>2</sup>

**Applicazione:** industria.

**Packing:** in busta da 1 pezzo

**Imballo minimo per ordine:** 1 pezzo

**Scatola:** 20 pezzi per taglia - volume m<sup>3</sup> 0,10 peso kg 12

**Articolo dotato di codice a barre**



Giubbotto indicato per saldatori e per operatori che svolgono mansioni a contatto con fiamma a propagazione limitata. La temperatura consigliata per il lavaggio del capo non deve superare i 40°C.

**Taglie:** M-L-XL-XXL

**Tessuto:** 100% cotone peso gr 220 m<sup>2</sup>

**Applicazione:** industria.

**Packing:** in busta da 1 pezzo

**Imballo minimo per ordine:** 1 pezzo

**Scatola:** 20 pezzi per taglia - volume m<sup>3</sup> 0,10 peso kg 9

**Articolo dotato di codice a barre**



art. 438S

[CE EN 470 EN531]



CE



Pantaloni fiamma-ritardante indicati per saldatori e per operatori che svolgono mansioni a contatto con fiamma a propagazione limitata. La temperatura consigliata per il lavaggio del capo non deve superare i 40°C.

**Taglie:** M-L-XL-XXL

**Tessuto:** 100% cotone peso gr 220 m<sup>2</sup>

**Applicazione:** industria.

**Packing:** in busta da 1 pezzo

**Imballo minimo per ordine:** 1 pezzo

**Scatola:** 20 pezzi per taglia - volume m<sup>3</sup> 0,10 peso kg 9

**Articolo dotato di codice a barre**



M-XXL

art. 14C

[CE EN 470]



CE



8 011818 102666



UNICA

Cuffia in tessuto pirovatex fiamma ritardante, da utilizzare assieme agli art. 436S e/o 437S + 438S

**Taglie:** UNICA

**Tessuto:** 100% cotone trattato ritardante peso gr 220 m<sup>2</sup>

**Applicazione:** industria.

**Packing:** in busta da 1 pezzo

**Imballo minimo per ordine:** 10 pezzi

**Scatola:** 20 pezzi - volume m<sup>3</sup> 0,05 - peso kg 4

**Articolo dotato di codice a barre**

art. 14CN



8 011818 129519

Cuffia in tessuto cotone 100%

**Packing:** 10 pz

**Imballo minimo per ordine:** 10 pz.

**Scatola:** 10 pz. - volume m<sup>3</sup> 0,03 - peso kg. 0,5

**Articolo dotato di codice a barre**



UNICA

## art. 645CE

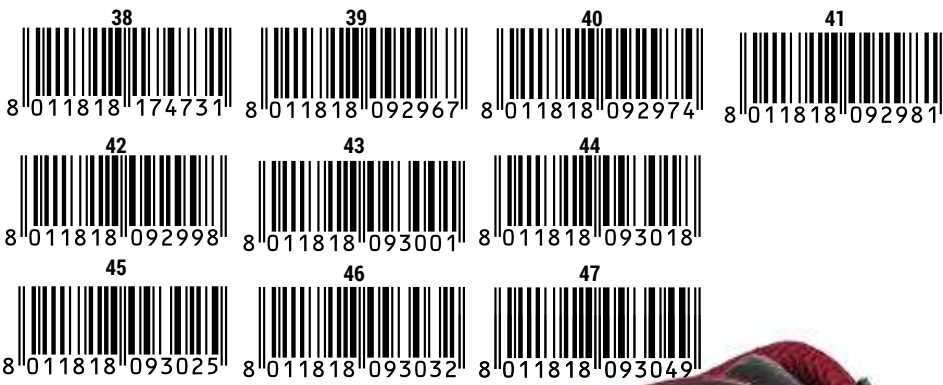
[EN ISO 20345 S3  
HRO SRC]

38 - 47



Calzatura alta con puntale composito e soletta tessile antiforo. Tomaia in vera pelle idrorepellente. Chiusura frontale mediante vercro® contro scorie di saldatura. Suola anticalore in gomma.

**Applicazioni:** edilizia, saldatura, industria pesante, navale..

**Packing:** 1 paio - **Peso** della TG 42 540 gr. circa.

**Imballo minimo per ordine:** da 6 paia per misura

**Volume scatola:** m<sup>3</sup> 0,10 (6 paia) - peso kg 11

**Articolo dotato di codice a barre**



## art. 644FBCE

[EN ISO 20345 - S1 SRC]



39 - 47



Calzatura alta S1 con fibbia e puntale in acciaio. Tomaia in vera pelle naturale, paramalleolo doppia imbottitura. Protezione metatarso contro scorie di saldatura. Suola in poliuretano bi-densità antistatica, antiolio, antiscivolo, antiacido.

**Applicazioni:** edilizia, saldatura, industria pesante, navale..

**Packing:** 1 paio - **Peso** della TG 42 530 gr. circa.

**Imballo minimo per ordine:** da 6 paia per misura

**Volume scatola:** m<sup>3</sup> 0,10 (6 paia) - peso kg 10

**Articolo dotato di codice a barre**



art. 30A7

[ EN 388 4233 - EN 407 - 412X4X ]



4233



412X4X



12

CE

UNICA 10



8 011818 143355

Guanto completamente in pieno fiore bovino idrorepellente. Con salvacuciture in pelle, palmo, pollice e paranocche rinforzate. Interno totalmente foderato in flanella. Cuciture totalmente in kevlar. Manichetta da cm. 8 in fiore bovino.

**Taglia:** unica 10

**Applicazione:** lavorazioni pesanti, saldatura, cantieri navali.

**Packing:** 12 paia

**Imballo minimo per ordine :** 60 paia

**Scatola:** 60 paia - volume m3 0,10 - peso kg. 10

**Articolo dotato di codice a barre**



CE



UNICA

art. 30A8

[ EN 388 4233 - EN 407  
EN 12477 - 412X4X ]



4233



412X4X



12

CE

UNICA 10



8 011818 143362

Guanto completamente in pieno fiore bovino idrorepellente. Con salvacuciture in pelle, palmo, pollice e paranocche rinforzate. Interno totalmente foderato in flanella. Cuciture totalmente in kevlar. Manichetta da cm. 15 in fiore bovino.

**Taglia:** unica 10

**Applicazione :** lavorazioni pesanti, saldatura, cantieri navali.

**Packing:** 12 paia

**Imballo minimo per ordine :** 60 paia

**Scatola:** 60 paia - volume m3 0,10 - peso kg. 10

**Articolo dotato di codice a barre**



CE



UNICA



## art. 49R

[EN388 2144]  
[EN407 - 413X4X]

CE

"CUCITURE IN KEVLAR"

10



8 011818 166705

Guanto tutto in crosta bovina anticalore, completo di salva cucitura, totalmente foderato internamente in tessuto di cotone. Colore rosso.

**Taglia:** 10**Applicazione:** Questo articolo è particolarmente adatto alla lavorazione in saldatura e nelle lavorazioni in presenza di calore.**Packing:** 12 paia**Imballo minimo per ordine:** 60 paia**Scatola:** 60 paia - volume m<sup>3</sup> 0,10 - peso kg. 10**Articolo dotato di codice a barre**

UNICA 10

## art. 49V

[EN388 2143]

CE

10



8 011818 102550

Guanto tutto in crosta bovina completo di salvacucitura, totalmente foderato internamente in tessuto di cotone. Colore verde

**Taglia:** 10**Applicazione:** industria della saldatura.**Packing:** 12 paia**Imballo minimo per ordine:** 60 paia**Scatola:** 60 paia - volume m<sup>3</sup> 0,10  
peso kg. 10**Articolo dotato di codice a barre**

UNICA 10

## art. 49VG

[EN388 2143]

CE

10



8 011818 107296

Guanto tutto in crosta bovina completo di salvacucitura, totalmente foderato internamente in tessuto di cotone. **Colore grigio**

**Taglia:** 10**Applicazione:** industria della saldatura.**Packing:** 12 paia**Imballo minimo per ordine:** 60 paia**Scatola:** 60 paia - volume m<sup>3</sup> 0,10 - peso kg. 12**Articolo dotato di codice a barre**

UNICA 10



2144



413X4X



12



2143



12



2143



12

art. 179

[EN 175/379]



8 011818 123227



Maschera a casco optoelettronica con alimentazione di energia mediante celle solari per la saldatura ad arco elettrico; tempo di commutazione chiaro-scuro 0,0005 secondi, temperatura di utilizzo 5C+55C. Livello di protezione impostabile tramite potenziometro esterno da Din 9 a Din 13. Indicato per saldatura MIG.

**Packing:** 1 pz.

**Imballo minimo per ordine:** 1 pz.

**Scatola:** 1 pz. - volume m<sup>3</sup> 0,05 - peso kg. 2

**Articolo dotato di codice a barre**



art. 182

[EN 175]



8 011818 130409



Maschera protettiva con caschetto in fibra nera per saldatori (senza vetro)  
Da completare con vetro art. 183, 184 (Dimensione 75 x 98 mm)

**Packing:** 10 pz

**Imballo minimo per ordine:** 10 pz.

**Scatola:** 10 pz. - volume m<sup>3</sup> 0,05 - peso kg. 2

**Articolo dotato di codice a barre**



art. 182N

[EN 175]



8 011818 125054



Maschera protettiva con caschetto in polipropilene per saldatori (senza vetro). Da completare con vetro art. 183 e 184 (Dimensione 75 x 98 mm)

**Packing:** 10 pz.

**Imballo minimo per ordine:** 10 pz.

**Scatola:** 10 pz. - volume m<sup>3</sup> 0,05 - peso kg. 2

**Articolo dotato di codice a barre**



art. 181

[EN 175]



8 011818 132694



Maschera per saldatori in fibra, inclinata (senza vetro)

Da completare con vetro art. 183 e 184

(Dimensione 75 x 98 mm)

**Packing:** 10 pz.

**Imballo minimo per ordine:** 10 pz.

**Scatola:** 10 pz. - volume m<sup>3</sup> 0,08 - peso kg. 5

**Articolo dotato di codice a barre**



## art. 180

[EN 175]



8 011818 106312



CE

Maschera dritta a mano in fibra per saldatori (senza vetro) Da completare con vetro art. 183, 184 e 185 (Dimensione 75 x 98 mm)

**Packing:** 10 pz.

**Imballo minimo per ordine:** 10 pz.

**Scatola:** 10 pz. - volume m<sup>3</sup> 0,03 - peso kg. 2

**Articolo dotato di codice a barre**

## art. 184

[EN166-169]



8 011818 128666

Vetrino inattinico per maschera art. 180 - 181 - 182 - 182N a norma CE. 100 pezzi. Dim. 75x98 mm.

**Packing:** 100 pz.

**Imballo minimo per ordine:** 100 pz.

**Scatola:** 100 pz. - volume m<sup>3</sup> 0,02 - peso kg. 1

**Articolo dotato di codice a barre**



CE

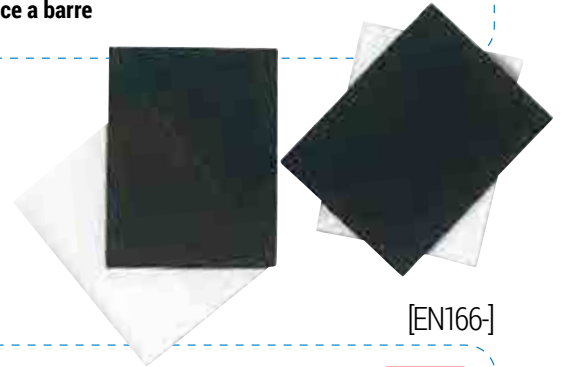

## art. 183

[EN166-]



8 011818 132700

Vetrino incolore per maschera art. 180 - 181 - 182 - 182N a norma CE. 100 pezzi. Dim. 75x98 mm.

**Packing:** 100 pz.

**Imballo minimo per ordine:** 100 pz.

**Scatola:** 100 pz. - volume m<sup>3</sup> 0,02 - peso kg. 1

**Articolo dotato di codice a barre**



CE

## art. 205N

[EN166 - EN169 - EN 175]



8 011818 095838



CE



Occhiale a mascherina da saldatore con lenti ribaltabili. (DIN 5)

**Packing:** 12 pz.

**Imballo minimo per ordine:** 12 pz.

**Scatola:** 12 pz. - volume m<sup>3</sup> 0,03 - peso kg. 1

**Articolo dotato di codice a barre e conf. appendibile**



## art. 209N

[EN 166 S167/168]



8 011818 095869



CE



Occhiale flessibile con lenti in minerale (Din 5) per saldatura

**Packing:** 10 pezzi

**Imballo minimo per ordine:** 10 pezzi.

**Scatola:** 10 pz. - volume m<sup>3</sup> 0,03 - peso kg. 1

**Articolo dotato di codice a barre e confezione appendibile**





## art. 211-2

Pinza portaelettrodo che consente il serraggio degli elettrodi in nove posizioni mediante sistema a leva. Impugnatura e rivestimento puntale in materiale termoindurente ininfiammabile ed anticalore; corpo in ottone pressofuso con serraggio cavo mediante sistema vite/piastrina; molla a compressione isolata. Leva in ottone stampato, isolata in annagamento plastico.

Marcatura: IEC 974 - 11EN60974-11.B 200/250

**Packing:** 1 pezzo

**Imballo minimo per ordine:** 10 pz.

**Scatola:** 10 pz. - volume m<sup>3</sup> 0,08 - peso kg. 3

**Articolo dotato di codice a barre**



## art. 214-2



Pinza per massa per ritorno di corrente, costituita da ganasce in acciaio trattato antiossidazione; placche di contatto in ottone; fissaggio del cavo di saldatura mediante fascetta e piastrina serracavo direttamente sulle lamelle di contatto; il morsetto è dotato di una derivazione fissa in nastro di rame in grado di portare la corrente assegnata: i contatti permettono la presa di pezzi tondi di piccolo diametro. Marcatura : 2 200 A35 BS638-5 CE

**Packing:** 1 pezzo

**Imballo minimo per ordine:** 10 pz.

**Scatola:** 10 pz. - volume m<sup>3</sup> 0,10 - peso kg. 4

**Articolo dotato di codice a barre**



## art. 215-3

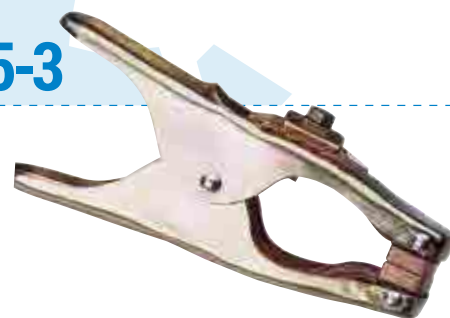

Pinza per massa per ritorno di corrente, costituita da ganasce in acciaio trattato antiossidazione; placche di contatto in ottone; fissaggio del cavo di saldatura mediante fascetta e piastrina serracavo direttamente sulle lamelle di contatto; il morsetto è dotato di una derivazione fissa in nastro di rame in grado di portare la corrente assegnata: i contatti permettono la presa di pezzi tondi di piccolo diametro. Marcatura : 3 300 A70 BS638-5 CE

**Packing:** 10 pz.

**Imballo minimo per ordine:** 1 pezzo

**Scatola:** 10 pz. - volume m<sup>3</sup> 0,10 - peso kg. 4

**Articolo dotato di codice a barre**



## art. 212-3

Pinza portaelettrodo che consente il serraggio degli elettrodi in nove posizioni mediante sistema a leva. Impugnatura e rivestimento puntale in materiale termoindurente ininfiammabile ed anticalore; corpo in ottone pressofuso con serraggio cavo mediante due grani a cava esagonale; molla a compressione isolata. Leva in ottone stampato, isolata in annagamento plastico. Marcatura : IEC 974 - 11EN60974-11.B 250/300

**Packing:** 1 pezzo

**Imballo minimo per ordine:** 10 pz.

**Scatola:** 10 pz. volume m<sup>3</sup> 0,08 - peso kg. 3

**Articolo dotato di codice a barre**



## art. 216-5



Pinza per massa per ritorno di corrente, costituita da ganasce in acciaio trattato antiossidazione; placche di contatto in ottone; fissaggio del cavo di saldatura mediante fascetta e piastrina serracavo direttamente sulle lamelle di contatto; il morsetto è dotato di una derivazione fissa in nastro di rame in grado di portare la corrente assegnata: i contatti permettono la presa di pezzi tondi di piccolo diametro. Marcatura : 5 400 A95 BS638-5 CE

**Packing:** 1 pezzo

**Imballo minimo per ordine:** 10 pz.

**Scatola:** 10 pz. - volume m<sup>3</sup> 0,10 - peso kg. 4

**Articolo dotato di codice a barre**



## art. 213-5

Pinza portaelettrodo che consente il serraggio degli elettrodi in nove posizioni mediante sistema a leva. Impugnatura e rivestimento puntale in materiale termoindurente ininfiammabile ed anticalore; corpo in ottone pressofuso con serraggio cavo mediante due grani a cava esagonale; molla a compressione isolata. Leva in ottone stampato, isolata in annagamento plastico. Marcatura : IEC 974 - 11EN60974-11.B 300/400

**Packing:** 1 pezzo

**Imballo minimo per ordine:** 10 pz.

**Scatola:** 10 pz. - volume m<sup>3</sup> 0,08 - peso kg. 3

**Articolo dotato di codice a barre**



## art. 217-6



Pinza per massa per ritorno di corrente, costituita da ganasce in acciaio trattato antiossidazione; placche di contatto in ottone; fissaggio del cavo di saldatura mediante fascetta e piastrina serracavo direttamente sulle lamelle di contatto; il morsetto è dotato di una derivazione fissa in nastro di rame in grado di portare la corrente assegnata: i contatti permettono la presa di pezzi tondi di piccolo diametro. Marcatura : 6 500 A120 BS638-5 CE

**Packing:** 1 pezzo

**Imballo minimo per ordine:** 10 pz.

**Scatola:** 10 pz. - volume m<sup>3</sup> 0,10 - peso kg. 4

**Articolo dotato di codice a barre**



## art. 91205



[EN 3-7]

Estintore a polvere da kg. 6

**Packing :** 1 pezzo

**Imballo minimo per ordine:** 1 pezzo

**Scatola:** da 1 pezzo - volume m<sup>3</sup> 0,07 - kg. 6

**Articolo dotato di codice a barre**

## art. 91202



[EN 3-7]

Estintore a polvere da kg. 1

**Packing :** 1 pezzo

**Imballo minimo per ordine:** 1 pezzo

**Scatola:** da 1 pezzo - volume m<sup>3</sup> 0,03 - kg. 1

**Articolo dotato di codice a barre**

## art. 91207



[EN 3-7]

Estintore a polvere da kg. 9

**Packing :** 1 pezzo

**Imballo minimo per ordine:** 1 pezzo

**Scatola:** da 1 pezzo - volume m<sup>3</sup> 0,10 - kg. 9

**Articolo dotato di codice a barre.**



ARTICOLI  
ALIMENTARE

MACELLI

art. 300

[EN 1082]



Guanto in maglia d'acciaio per macellai, bordino rosso

**Taglie:** M

**Applicazione:** industria alimentare.

**Packing:** 1 pezzo

**Imballo minimo per ordine:** 1 pezzo

**Scatola:** 1 pezzo - volume m<sup>3</sup> 0,03 - peso kg. 0,2

**Articolo dotato di codice a barre**



art. 300A

[EN 1082]



Guanto in maglia di acciaio, con protezione avambraccio in materiale plastico resistente al taglio, bordino rosso

**Applicazione:** industria alimentare.

**Taglia:** M - **Packing:** 1 pezzo

**Imballo minimo per ordine:** 1 pezzo

**Scatola:** 1 pezzo - volume m<sup>3</sup> 0,04 - peso kg. 0,3

**Articolo dotato di codice a barre**



art. 300VE

art. 300BI



XS



S



art. 300BL



L



BORDINO BLUE



art. 300AVE



XS



BORDINO VERDE



art. 300ABI



S



BORDINO BIANCO



art. 300ABL



L



BORDINO BLUE



art. 350

[EN 13998]



CE

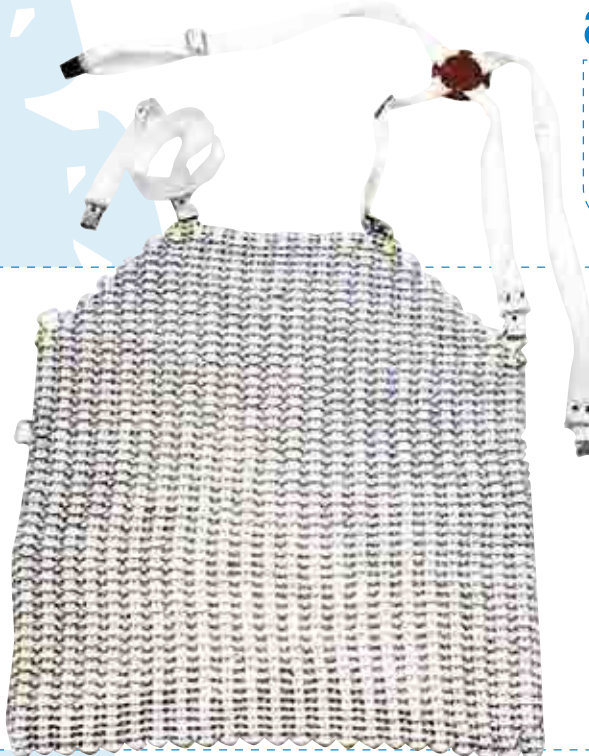

**Grembiule in placche di alluminio per macellai**

**Dimensione:** cm 55 x 70

**Applicazione:** edilizia - industria - magazzini - alimentare

**Packing:** in busta da 1 pezzo

**Imballo minimo per ordine:** 1 pezzo

**Scatola:** 10 pezzi - volume m<sup>3</sup> 0,10 peso kg 15

**Articolo dotato di codice a barre**



UNICA



art. 462BD

[CE - Cat.1]



Camice bianco da donna in cotone - bottoni ricoperti - elastico ai polsi  
**Taglie:** 38/50 - **Tessuto:** 100% cotone peso gr 220 m<sup>2</sup>  
**Applicazione:** edilizia, alimentare, sanitario, ospedaliero  
**Packing:** in busta da 1 pezzo  
**Imballo minimo per ordine:** 5 pezzi per taglia e/o multipli  
**Scatola:** 20 pezzi per taglia - volume m<sup>3</sup> 0,10 - peso kg 9  
**Articolo dotato di codice a barre**



38 - 50

art. 462B

[CE - Cat.1]



Camice bianco da uomo in cotone - bottoni ricoperti - elastico ai polsi  
**Taglie:** 44/60 **Tessuto:** 100% cotone peso gr 220 m<sup>2</sup>  
**Applicazione:** edilizia, alimentare, sanitario, ospedaliero  
**Packing:** in busta da 1 pezzo  
**Imballo minimo per ordine:** 5 pezzi per taglia e/o multipli  
**Scatola:** 20 pezzi per taglia - volume m<sup>3</sup> 0,10 - peso kg 9  
**Articolo dotato di codice a barre**



44 - 60

art. 462BID

[CE - Cat.1]



Camice bianco da donna in cotone - bottoni ricoperti - elastico ai polsi  
**Taglie:** 40/50 **Tessuto:** 100% cotone peso gr 140 m<sup>2</sup>  
**Applicazione:** edilizia, alimentare, sanitario, ospedaliero  
**Packing:** in busta da 1 pezzo  
**Imballo minimo per ordine:** 5 pezzi per taglia e/o multipli  
**Scatola:** 20 pezzi per taglia - volume m<sup>3</sup> 0,10 - peso kg 8  
**Articolo dotato di codice a barre**



40 - 50

art. 462BI

[CE - Cat.1]



Camice bianco da uomo in cotone - bottoni ricoperti - elastico ai polsi  
**Taglie:** 46/60  
**Tessuto:** 100% cotone peso gr 140 m<sup>2</sup>  
**Applicazione:** edilizia, alimentare, sanitario, ospedaliero  
**Packing:** in busta da 1 pezzo  
**Imballo minimo per ordine:** 5 pezzi per taglia e/o multipli  
**Scatola:** 20 pezzi per taglia - volume m<sup>3</sup> 0,10 - peso kg 8  
**Articolo dotato di codice a barre**



46 - 60



## art. 461BI

[CE - Cat.1]



## art. 461OSB

[CE - Cat.1]

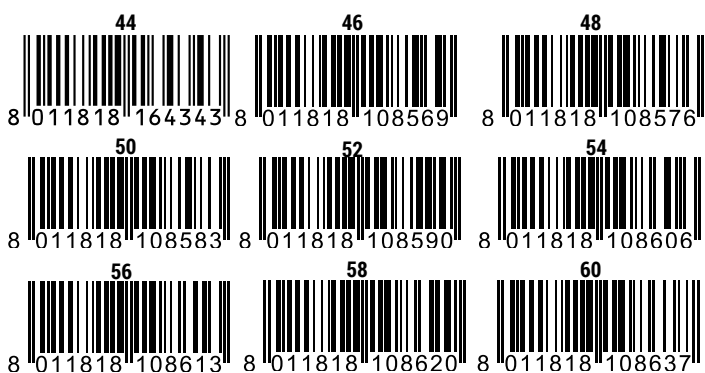

Pantaloni uomo in cotone 100% - gr 250 m<sup>2</sup> con portametro.

**Taglia:** 44-60

**Applicazione:** alimentare

**Packing:** 1 busta da 1 pezzo

**Imballo minimo per ordine:** 5 pezzi per taglia e/o multipli

**Scatola:** 20 pezzi - volume m<sup>3</sup> 0,10 Kg.9

**Articolo dotato di codice a barre**



44 - 60



Pantalone in cotone, ospedaliero e alimentare, con tasche - bianco

**Taglie:** M-L-XL-XXL

**Tessuto:** 100% cotone peso gr 200 m<sup>2</sup>

**Applicazione:** settore alimentare

**Packing:** in busta da 1 pezzo

**Imballo minimo per ordine:** 1 pezzo

**Scatola:** 20 pezzi per taglia - volume m<sup>3</sup> 0,10 - peso kg 8

**Articolo dotato di codice a barre**



M-XXL

art. 951GBI

[CE - Cat.1]



Gilet huski colore bianco.

**Taglie:** M-L-XL-XXL

**Tessuto:** Nylon

**Interno:** Nylon - imbottitura in poliestere

**Applicazione:** alimentare

**Packing:** in busta da 1 pezzo

**Imballo minimo per ordine:** 10 pezzi

**Scatola:** 10 pezzi per taglia - volume m<sup>3</sup> 0,10 - peso kg 8

**Articolo dotato di codice a barre**



M - XXL

art. 016



Parannanza in cotone

**Misura:** cm 70 x 90

**Tessuto:** 100% cotone peso gr 240 m<sup>2</sup> - restringimento max 2%

**Applicazione:** alimentare

**Packing:** 10 pezzi

**Imballo minimo per ordine:** 40 pezzi

**Scatola:** 40 pezzi - volume m<sup>3</sup> 0,07 - peso kg 5

**Articolo dotato di codice a barre**



UNICA

art. 300B

CE



Grembiule in poliuretano per grassi animali - colore bianco. Resistente al calore fino a 85° C.

**Dimensione:** cm 90 x 115

**Spessore:** mm 0,35

**Applicazione:** alimentare

**Packing:** in busta da 1 pezzo

**Imballo minimo per ordine:** 1 pezzo

**Scatola:** 10 pezzi - volume m<sup>3</sup> 0,07 - peso kg 7

**Articolo dotato di codice a barre**



UNICA

## art. 105A BI - cm 75x120

Grebiule con rinforzo nella parte centrale pvc/poliestere/pvc

**Materiale:** pvc/poliestere/pvc rinforzato nella parte centrale

**Spessore:** mm.0,32 - Rinforzo interno mm. 0,50

**Applicazione:** settore alimentare

**Packing:** 10 pezzi

**Imballo minimo per ordine:** 20 pezzi

**Scatola:** 10 pezzi - volume m<sup>3</sup> 0,07 - peso kg 7

**Articolo dotato di codice a barre**



8 011818 104844



## art. 105 BI - cm 75x100



8 011818 104837



## art. 105 BBI - cm 90x120



8 011818 104851



CE

## art. 91PL



8 011818 122343



Grebiule in polietilene

**Dimensione:** cm 70x125

**Applicazione:** settore alimentare

**Packing:** in scatola da 1000 pz.

**Imballo minimo per ordine:** 1000 pezzi

**Scatola:** 1000 pezzi - volume m<sup>3</sup> 0,10 - peso kg 5

**Articolo dotato di codice a barre**

## art. 126



8 011818 124675



Manicotti in PLP con elastico

**Taglia:** unica

**Materiale:** polipropilene peso gr 40 m<sup>2</sup>

**Applicazione:** settore alimentare

**Packing:** in busta da 100 paia

**Imballo minimo per ordine:** 100 paia

**Scatola:** 100 paia - volume m<sup>3</sup> 0,08 - peso kg 5

**Articolo dotato di codice a barre**

## art. 462MTBD

[CE - Cat.1]

P/C



Camice da donna in 65% poliestere 35% cotone, peso 140 gr/m<sup>2</sup>

**Taglie:** 38/44

**Tessuto:** poliestere/cotone

**Applicazione:** alimentare

**Packing:** in busta da 1 pezzo

**Imballo minimo per ordine:** 5 pezzi per taglia e/o multipli

**Scatola:** 20 pezzi per taglia - volume m<sup>3</sup> 0,10 - peso kg 8

**Articolo dotato di codice a barre**



38 - 44

## art. 462MTC

[CE - Cat.1]

P/C



Camice da donna a manica corta in 65% poliestere / 35% cotone, peso 140 gr/m<sup>2</sup>

**Taglie:** 38/42

**Tessuto:** poliestere/cotone

**Applicazione:** alimentare

**Packing:** in busta da 1 pezzo

**Imballo minimo per ordine:** 5 pezzi per taglia e/o multipli

**Scatola:** 20 pezzi per taglia - volume m<sup>3</sup> 0,10 - peso kg 8

**Articolo dotato di codice a barre**



38 - 42

art. 461BV

[CE - Cat.1]

art. 458BV

[CE - Cat.1]

P/C



Pantalone bicolore in poliestere 65% / cotone 35%, peso gr. 180/m<sup>2</sup> - con tasca porta ginocchiera. elastico in vita regolabile.

**Taglie:** M-L-XL-XXL-XXXL

**Tessuto:** poliestere/cotone

**Applicazione:** alimentare

**Packing:** 1 pezzo

**Imballo minimo per ordine:** 1 pezzo

**Scatola:** 10 pezzi per taglia - volume m<sup>3</sup> 0,10 - peso kg 8

**Articolo dotato di codice a barre e confezione appendibile**

Pettorina multitasche bicolore in poliestere 65% / cotone 35%, peso gr. 180/m<sup>2</sup> - con tasca portaginocchiera. elastico in vita regolabile.

**Taglie:** S-M-L-XL-XXL-XXXL

**Tessuto:** poliestere/cotone

**Applicazione:** alimentare

**Packing:** 1 pezzo

**Imballo minimo per ordine:** 1 pezzo

**Scatola:** 10 pezzi per taglia - volume m<sup>3</sup> 0,10 - peso kg 9

**Articolo dotato di codice a barre e confezione appendibile**



M-XXXL



S-XXXL

art. 460BV

[CE - Cat.1]

P/C



-40°C



Giubbotto bicolore in poliestere 65% / cotone 35%,  
 peso gr. 180/m2  
**Taglie:** M-L-XL-XXL-XXXL  
**Tessuto:** poliestere/cotone  
**Applicazione:** imbianchini, edilizia, magazzini  
**Packing:** 1 pezzo  
**Imballo minimo per ordine:** 1 pezzo  
**Scatola:** 10 pezzi per taglia - volume m<sup>3</sup> 0,10 - peso kg 8  
**Articolo dotato di codice a barre e confezione appendibile**



M-XXXL

art. 25

[EN ISO 20345 S4 SRC]

PU

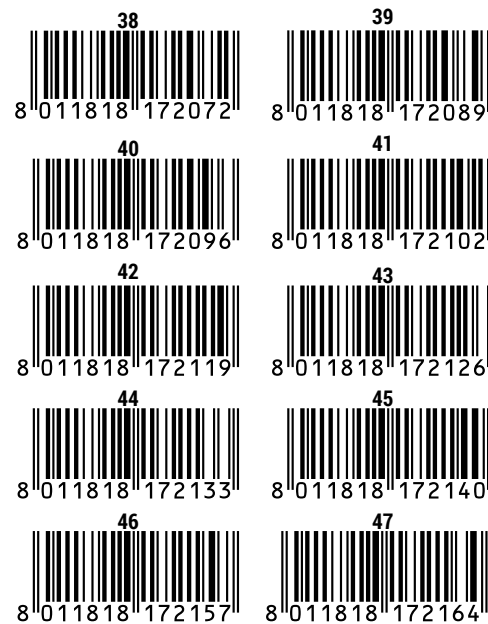

Stivale in poliuretano bianco.  
 Suola carrarmato antiscivolo.  
**Applicazione:** industria alimentare, basse temperature (- 40 °C.)  
**Taglie:** 38/47  
**Imballo minimo per ordine:** 1 paio  
**Volume scatola:** 0,16 m<sup>3</sup> - 6 paia kg. 9  
**Articolo dotato di codice a barre.**



38 - 47

art. 19BCE

[EN ISO 20345 S4 SRA]



NITRILE



36 8 011818 009361	37 8 011818 009378	38 8 011818 101867
39 8 011818 101874	40 8 011818 101881	41 8 011818 101898
42 8 011818 101904	43 8 011818 101911	44 8 011818 101928
45 8 011818 101935	46 8 011818 101942	



36 - 46

Stivale al ginocchio in gomma nitrilica bianca, suola grigia antiscivolo, con puntale in acciaio, resistente ai grassi animali, oli, acidi, antistatica.

**Taglie:** 36/46

**Applicazione:** alimentare, farmaceutica, caseario, macelli

**Packing:** 1 paio

**Imballo minimo per ordine:** 1 paio

**Scatola:** 6 paia - volume m<sup>3</sup> 0,15 - peso Kg. 10

**Articolo dotato di codice a barre**

art. 18ACE

[EN ISO 20347 SRA]



NITRILE



36 8 011818 102031	37 8 011818 102048	38 8 011818 102055
39 8 011818 102062	40 8 011818 102079	41 8 011818 102086
42 8 011818 102093	43 8 011818 102109	44 8 011818 102116
45 8 011818 102123	46 8 011818 134025	



36 - 46

Stivale al ginocchio in gomma nitrilica bianca, senza puntale. Suola grigia antiscivolo resistente ai grassi animali, oli e acidi, antistatica.

**Taglie:** 36/46

**Applicazione:** settore alimentare

**Packing:** 1 paio

**Imballo minimo per ordine:** 6 paia per misura

**Scatola:** 6 paia - volume m<sup>3</sup> 0,15 - peso Kg. 9

**Articolo dotato di codice a barre**

## art. 624SLNMCE

[EN ISO 20345 - S3 - SRC]

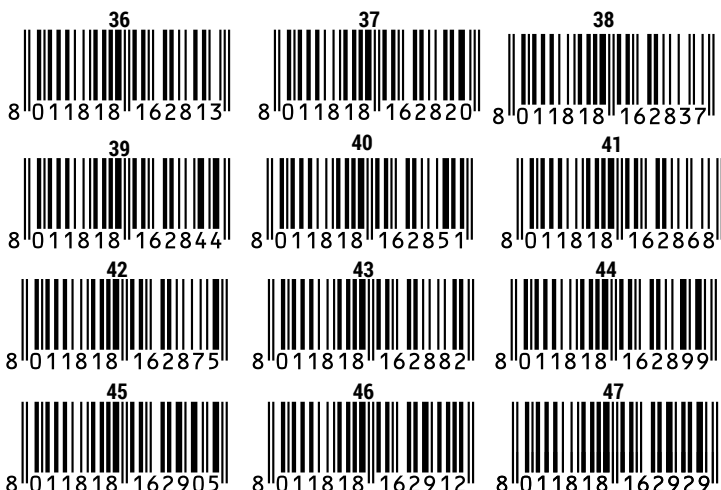

Calzatura bassa con puntale in composito e soletta tessile antiforo. Tomaia in MICROFIBRA traspirante. Suola in gomma nitrilica trasparente antistatica, antiscivolo, anticalore, antiacido.

**Peso:** gr. 430 nella taglia 42

**Applicazione:** settore alimentare - imbianchini.

**Taglie:** 36/47

**Imballo minimo per ordine:** 1 paio

**Volume scatola:** 0,16 m<sup>3</sup> - 6 paia kg. 9

**Articolo dotato di codice a barre.**



36 - 47

## art. 625NMCE

[EN ISO 20345 - S2 - SRC]



Sandalo con puntale in composito  
Tomaia in MICROFIBRA traspirante.

Suola in gomma nitrilica trasparente antistatica, antiscivolo, anticalore, antiacido.

**Peso:** gr. 430 nella taglia 42

**Applicazione:** settore alimentare - imbianchini.

**Taglie:** 36/47

**Imballo minimo per ordine:** 1 paio

**Volume scatola:** 0,16 m<sup>3</sup> - 6 paia kg. 9

**Articolo dotato di codice a barre.**



36 - 47



art. 625CE

[EN ISO 20345-S2-SRC]



35 - 47



SANDALO S2

Sandalo con puntale in acciaio. Tomaia in microfibra traspirante e idrorepellente completa di cinturino. Suola in poliuretano espanso antistatico e antiscivolo iniettato direttamente alla tomaia.

Il suddetto articolo è prodotto con materiali speciali, che ne permettono il lavaggio in lavatrice, alla temperatura di 30°C

**Taglie:** 35/47

**Imballo minimo per ordine:** 1 paio

**Volume scatola:** m<sup>3</sup> 0,10 (6 paia) - peso kg 10

**Articolo dotato di codice a barre**

art. 624SLCE

[EN ISO 20345-S2-SRC]



35 - 47

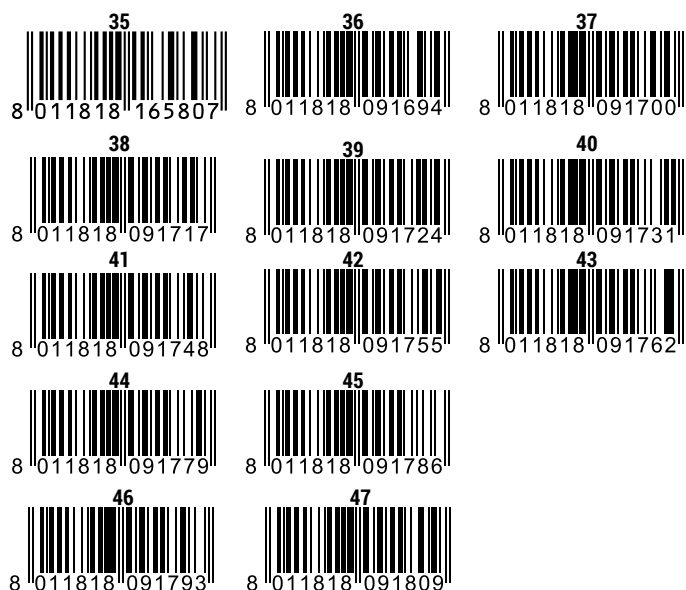

SCARPA BASSA BIANCA S2

Calzatura bassa bianca idrorepellente con puntale in acciaio, tomaia in microfibra. Suola in PU monodensità antistatica, antiacido, antiolio, antiscivolo. Indicata nelle seguenti lavorazioni: della carne, casearia, alimentare, farmaceutica, ecc

**Taglie:** 35/47

**Imballo minimo per ordine:** 1 paio

**Volume scatola:** m<sup>3</sup> 0,10 (6 paia) - peso kg 10

**Articolo dotato di codice a barre**

## art. 0250CE

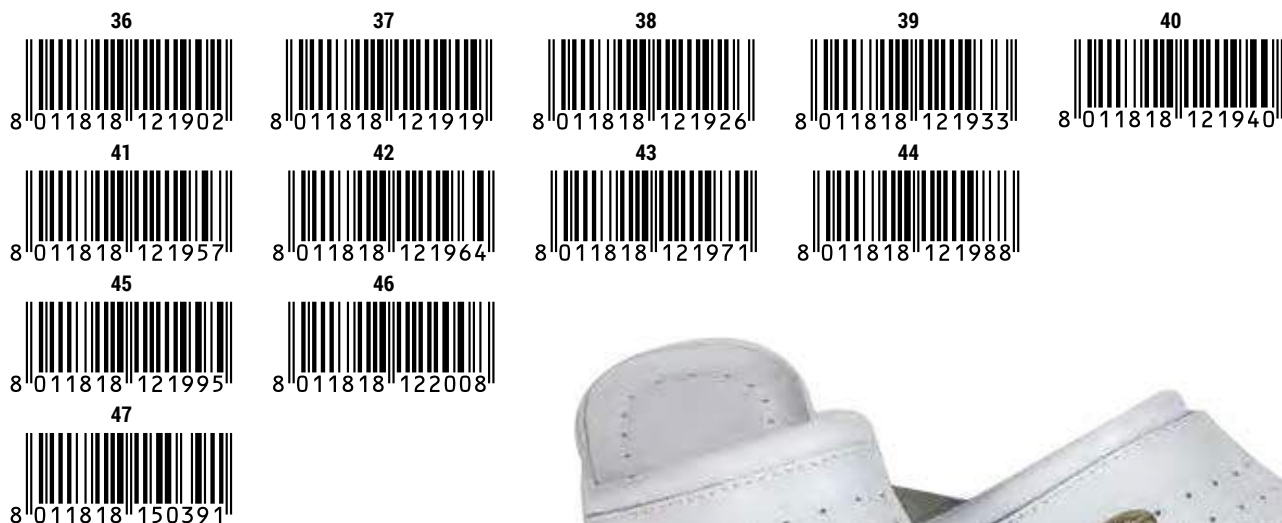

Zoccolo in pelle traforata traspirante e sottopiede in scamosciato. Suola in poliuretano.

**Applicazione:** alimentare

**Taglie:** 36/47

**Imballo minimo per ordine:** 6 paia per misura.

**Volume scatola:** 0,10 m<sup>3</sup> - 6 paia kg. 7

**Articolo dotato di codice a barre.**



36 - 47

## art. 0260CE

[EN ISO 20347 - SRA]

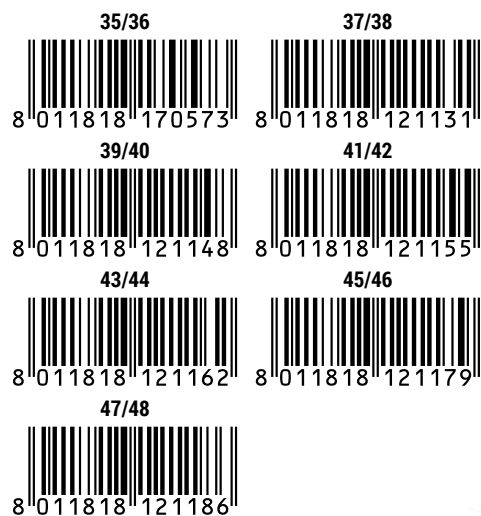

Zoccolo in polivinile autoclavabile a 130°C, sterilizzabile. Indicato per: alimentaristi, macellai, sanitari, ospedalieri. Colore Bianco

**Taglie:** 35/48

**Imballo minimo per ordine:** 1 paio

**Volume scatola:** m<sup>3</sup> 0,10 (6 paia) - peso kg 10

**Articolo dotato di codice a barre**



35 - 48

## art. 290

[EN388 2241]



2241



Guanto in nylon 7G.

**Taglia:** 8-9-10**Applicazione:** utilizzabile come sottoguanto, nei magazzini o nei lavori di precisione.**Packing:** 12 paia**Imballo minimo per ordine:** 120 paia**Scatola:** 120 paia - volume m3 0,08 - peso kg. 7**Articolo dotato di codice a barre e confezione appendibile.**

8 - 10

## art. 0360

[EN374-EN388 4110]



4110



8 - 10

Guanto in nitrile lungo cm 60

spess. mm 0,2 manicotto leggero in EVA

**Taglie:** 8 - 9 - 10**Applicazione:** industria, edilizia, ispezione**Packing:** 1 paio**Imballo minimo per ordine:** 1 paio**Scatola:** 12 paia - volume m<sup>3</sup> 0,04 - Kg.4**Articolo dotato di codice a barre**

## art. 62NDS

[EN455-1/2/3+A1 2011]



BOX  
50

**NO POWDER**



Guanto in nitrile senza polvere interna, per uso alimentare.  
Doppio spessore (mm 0,15).  
Lunghezza cm 26.  
**Taglie:** M - L - XL - XXL  
**Applicazione:** alimentare  
**Packing:** 1 box (50pz)  
**Imballo minimo per ordine:** 10 box da 50 pz. cadauno  
**Scatola:** 10 box - volume m<sup>3</sup> 0,07 - peso kg. 6  
**Articolo dotato di codice a barre e confezione appendibile**

**STRONG  
NITRILE**



CE



## art. 64P

[EN 420 - EN 374]

CE

0 0 8 8



BOX  
100

**POWDER  
LATEX**



Guanto in lattice con polvere interna per uso alimentare. 100 pezzi  
**Applicazione:** uso alimentare.  
**Taglie:** 6,5 - 7,5 - 8,5 - 9,5  
**Packing:** 1 box (100pz.)  
**Imballo minimo per ordine:** 10 box  
**Scatola:** 10 box  
**Articolo dotato di codice a barre.**



CE



## art. 64DS

[CE EN374 1/2/3 - EN388]

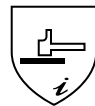

BOX  
50

**NO POWDER  
STRONG LATEX**



Guanto in lattice blu doppio spessore, senza polvere, lunghezza cm 30 ( box 50 pz )  
**Applicazione :** industria alimentare.  
**Taglie :** M-L-XL  
**Packing :** 50 pz  
**Imballo minimo per ordine:** 10 box  
**Articolo dotato di codice a barre**



CE



art. 64A

[EN388 EN374-2 EN374-3]



BOX  
100

Guanti in lattice (box 100 pezzi)  
con polvere interna

**Applicazione:** alimentare

**Taglie:** S - M - L - XL

**Packing:** 1 box (100 pz.)

**Imballo minimo per ordine:** 10 box

**Scatola:** 10 box - volume m<sup>3</sup> 0,08 - peso Kg. 7

**Articolo dotato di codice a barre.**



**POWDER  
LATEX**



S - XL

art. 6

[EN374 - EN388 4120]

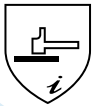

4120



Guanto in gomma uso industriale  
cm 32 - Spessore 0,90 mm

**Taglie:** 7 - 8 - 9 - 10

**Applicazione:** industria alimentare

**Packing:** 10 paia

**Imballo minimo per ordine:** 50 paia

**Scatola:** 50 paia - volume m<sup>3</sup> 0,10 -  
peso Kg. 10

**Articolo dotato di codice a barre**



7 - 10

art. 65M

[EN374 EN388 3000]



3000



Guanto in lattice naturale - satinato  
- cm 30

**Taglie:** 7 - 8 - 9 - 10

**Applicazione:** alimentare

**Packing:** 12 paia

**Imballo minimo per ordine:** 144 paia

**Scatola:** 144 paia - volume m<sup>3</sup> 0,10 -  
peso Kg. 9

**Articolo dotato di codice a barre**



7 - 10

art. 65

[EN420 - CAT. 1]



Guanto casalingo in lattice floccato - cm 27

**Applicazione:** industria alimentare

**Taglie:** 7 - 8 - 9 - 10

**Packing:** 12 paia

**Imballo minimo per ordine:** 144 paia

**Scatola:** 144 paia - volume m<sup>3</sup> 0,10 - peso kg. 9

**Articolo dotato di codice a barre**



7 - 10

art. 60A

[EN374 - EN388 1011]



1011



Guanto in neoprene bicolore - cm 32

Spessore 0,50 mm

**Taglie:** 7 - 8 - 9 - 10

**Applicazione:** industria alimentare

**Packing:** 10 paia

**Imballo minimo per ordine:** 100 paia

**Scatola:** 100 paia - volume m<sup>3</sup> 0,09 - peso Kg. 9

**Articolo dotato di codice a barre**



7 - 10

art. 404PL



Copriscarpa in polietilene con elastico

**Taglia:** unica

**Materiale:** Polietilene

**Applicazione:** industria alimentare

**Packing:** in confezione da 500 paia

**Imballo minimo per ordine:** paia 500

**Scatola:** 500 paia - volume m<sup>3</sup> 0,10 - peso kg 5

**Articolo dotato di codice a barre**



UNICA

## art. 35PL



Cuffia rotonda con elastico in PPL bianca. Indicata nel settore alimentare ed industrie attinenti

**Taglia:** unica

**Materiale:** Polipropilene peso gr. 20 m<sup>2</sup>

**Applicazione:** industria alimentare

**Packing:** in confezione da 500 pezzi

**Imballo minimo per ordine:** 500 pezzi

**Scatola:** 500 pezzi - volume m<sup>3</sup> 0,05 - peso kg 0,450

**Articolo dotato di codice a barre**

## art. 33PL



Cappellino da donna in tessuto non tessuto, con visiera e reggicapelli alla nuca. Indicato nel settore alimentare ed industrie attinenti.

**Taglia:** unica - **Materiale:** Tessuto non tessuto peso gr 40 m<sup>2</sup>

**Applicazione:** industria alimentare

**Packing:** in confezione da 500 pezzi

**Imballo minimo per ordine:** 500 pezzi

**Scatola:** 500 pezzi per taglia -

volume m<sup>3</sup> 0,08 - peso kg 1,5

**Articolo dotato di codice a barre**

## art. 14EC



Copricapo in cotone con raccogliacapelli

**Taglia:** unica

**Materiale:** cotone

**Applicazione:** industria alimentare

**Packing:** in confezione da 10 pezzi

**Imballo minimo per ordine:** 10 pezzi

**Scatola:** 100 pezzi per taglia - volume m<sup>3</sup> 0,08 - peso kg 1,5

**Articolo dotato di codice a barre**

## art. 31PL



Cappellino con visiera PPL unisex con elastico alla nuca in tessuto non tessuto, indicato nel settore alimentare ed industrie attinenti

**Taglia:** unica

**Materiale:** Tessuto non tessuto peso gr. 40 m<sup>2</sup>

**Applicazione:** industria alimentare

**Packing:** in cartone da 500 pezzi

**Imballo minimo per ordine:** 500 pezzi

**Scatola:** 500 pezzi - volume m<sup>3</sup> 0,08 - peso kg 1,5

**Articolo dotato di codice a barre**

## art. 14EA

Bustina unisex in cotone

**Taglia:** unica

**Tessuto:** cotone 100%

- peso gr 120 m<sup>2</sup>

**Applicazione:** industria alimentare

**Packing:** in busta da 10 pezzi

**Imballo minimo per ordine:** 10 pezzi

**Scatola:** 20 pezzi - volume m<sup>3</sup> 0,05 - peso kg 1,5

**Articolo dotato di codice a barre**



art. 61



8 011818 130195

Bavaglio monouso - Dimensione cm 48x60

**Applicazione:** settore alimentare

**Packing:** 100 pezzi

**Imballo minimo per ordine:** pz. 600

**Scatola:** 600 pz. - volume m<sup>3</sup> 0,05 - peso kg 2

**Articolo dotato di codice a barre**

art. 123

[CE CAT. 1]



M  
8 011818 112740



L  
8 011818 112757



XL  
8 011818 112764



XXL  
8 011818 112771

Camice in polipropilene con bottoni e tasca frontale, usa e getta - Prima categoria. Peso gr. 30 m<sup>2</sup>

**Taglie:** M-L-XL-XXL

**Materiale:** polipropilene

**Applicazione:** settore alimentare.

**Packing:** 25 pezzi

**Imballo minimo per ordine:** 25 pezzi per taglia e/o multipli

**Scatola:** 25 pezzi per taglia - volume m<sup>3</sup> 0,08 - peso kg 4

**Articolo dotato di codice a barre**



art. 123C

[CE CAT. 1]



M  
8 011818 149852



L  
8 011818 149869



XL  
8 011818 149876



XXL  
8 011818 149883

Camice in polipropilene con VELCRO, usa e getta. Peso gr. 30 m<sup>2</sup>. Prima categoria. Tasca su cuore ed elastico ai polsi.

**Taglia:** M-L-XL-XXL

**Applicazione:** settore alimentare

**Packing:** 25 pezzi

**Imballo minimo per ordine:** 25 pezzi

**Scatola:** 25 pezzi per taglia - volume m<sup>3</sup> 0,08 Kg.4

**Articolo dotato di codice a barre**



M - XXL



art. 120DTS

[Cat.3 Type 4-5-6]

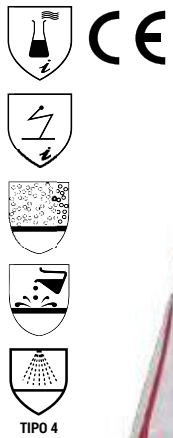

TIPO 4



Tuta cucita e termosaldada antistatica e traspirante ( per schizzi pericolosi) 3a categoria. Con cappuccio , lestico ai polsi e caviglie - zip centrale e due mandate.

**Taglie:** M-L-XL-XXL-XXXL

**Tessuto:** SMMS

**Applicazione:** industria, agricoltura, edilizia, chimica, smaltimento amianto.

**Packing:** in busta da 1 pezzo.

**Imballo minimo per ordine :** 25 pezzi per taglia e/o multipli

**Scatola :** 25 pezzi per taglia - volume m<sup>3</sup> 0,08 - peso kg. 8

**Articolo dotato di codice a barre**



art. 120D

[CE CAT.3 TYPE5 - EN13982-1:2004  
TYPE6 - EN13034-1:2005 - EN1149]

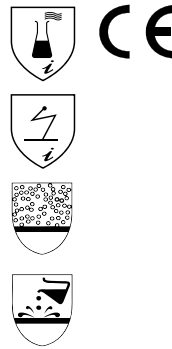

Tuta cucita e ribattuta antistatica e traspirante (per schizzi pericolosi) 3° categoria

**Taglie:** M-L-XL-XXL-XXXL - **Tessuto:** SMMS ®

**Applicazione:** industria, agricoltura, edilizia, chimica

**Packing:** in busta da 1 pezzo

**Imballo minimo per ordine:** 25 pezzi per taglia e/o multipli

**Scatola:** 25 pezzi per taglia - volume m<sup>3</sup> 0,08 - peso kg 8

**Articolo dotato di codice a barre**



art. 112

[CE - Cat.1]



Tuta in polipropilene usa e getta con cappuccio - prima categoria.

**Taglie:** M-L-XL-XXL

**Materiale:** polipropilene peso gr 40 m<sup>2</sup>

**Applicazione:** industria, agricoltura, edilizia, pulizia

**Packing:** in busta da 1 pezzo

**Imballo minimo per ordine:** 25 pezzi per taglia e/o multipli

**Scatola:** 25 pezzi per taglia - volume m<sup>3</sup> 0,08 - peso kg 7

**Articolo dotato di codice a barre**



art. 120C

[EN 13034 - 13982  
TYPE 5-6 EN 1149]



Tuta usa e getta tipo antistatica e traspirante (per schizzi leggeri)

**Taglie:** M-L-XL-XXL

**Tessuto:** Lakeland®

**Applicazione:** industria, agricoltura, edilizia

**Packing:** in busta da 1 pezzo

**Imballo minimo per ordine:** 25 pezzi per taglia e/o multipli

**Scatola:** 25 pezzi per taglia - volume m<sup>3</sup> 0,08 - peso kg 8

**Articolo dotato di codice a barre**



art. 113

[CE - Cat.1]



8 011818 103991



8 011818 104004



8 011818 104011



8 011818 104028

Tuta **BLU** in polipropilene usa e getta con cappuccio - prima categoria.

**Taglie:** M-L-XL-XXL

**Materiale:** polipropilene peso gr 40 m<sup>2</sup>

**Applicazione:** industria, agricoltura, edilizia, pulizia

**Packing:** in busta da 1 pezzo

**Imballo minimo per ordine:** 25 pezzi per taglia e/o multipli

**Scatola:** 25 pezzi per taglia - volume m<sup>3</sup> 0,08 - peso kg 7

**Articolo dotato di codice a barre**



M-XXL



# INDICE

## ELMETTI-LAMPADE

Elmetti.....	pag. 301
Lampade.....	pag. 302
Visiere.....	pag. 305

## PROTEZIONE UDITO

Elmetti con cuffie antirumore.....	pag. 302
Cuffie Antirumore.....	pag. 305
Tappi antirumore.....	pag. 306

## PROTEZIONE VISTA

Norme protezione vista.....	pag. 308
Occhiali.....	pag. 310

## PROTEZIONE RESPIRATORIA

Norme protezione vie respiratorie.....	pag. 316
Facciali Filtranti.....	pag. 318
Facciali Filtranti - Semimaschere BLS.....	pag. 321
Semimaschere BLS.....	pag. 322
Pieno Facciali BLS.....	pag. 323
Semimaschere.....	pag. 324

## 3M

Facciali Filtranti 3M.....	pag. 325
Maschere - Semimaschere 3M.....	pag. 328
Facciali filtranti 3M.....	pag. 329
Filtri 3M.....	pag. 330
Protezione udito 3M.....	pag. 334





**SAFETY**  
**SAFETY**

**ELMETTO  
VISTIERE**

**TAPPA  
SUFFIE**

**FACCIALE  
FILTRANTI**

**OCCHIALE**



SEBA



## Elmetto

[EN 397]



CE

Elmetto giallo in polietilene EN397 - 440V

**Packing:** 1 pezzo**Imballo minimo per ordine:** 20 pezzi**Scatola:** 20 pezzi - volume m<sup>3</sup> 0,15 - peso kg. 7**Articolo dotato di codice a barre**

## art. 427

## art. 427SC



COLOR



8 011818 095739



COLOR



8 423343 200128

## art. 427BI

## art. 427BI-SC



COLOR



8 011818 095746



COLOR



8 423343 200111

## art. 427AR

## art. 427AR-SC



COLOR



8 011818 095753



COLOR



8 423343 200173

## art. 427RO

## art. 427RO-SC



COLOR



8 011818 149005



COLOR



8 423343 200159

## art. 427BL

## art. 427BL-SC



COLOR



8 011818 148992



COLOR



8 423343 200135

## Elmetto con rotella

[EN 397]

Elmetto regolabile tramite rotella

**Applicazione:** Edilizia**Packing:** 1 pezzo**Imballo minimo per ordine:** 10 pz.**Scatola:** 10 pz. -volume m<sup>3</sup> 0,08 - peso kg. 4**Articolo dotato di codice a barre**

## art. 427REB



COLOR



8 011818 135718

## art. 427REBL

## art. 427RE



COLOR



8 011818 148978



COLOR



8 011818 111972

## art. 427C

[EN 397]



CE



8 011818 130157

Elmetto giallo con visiera FLAT con sottogola inserito.

**Packing:** 1 pezzo**Imballo minimo per ordine:** 1 pz.**Scatola:** 40 pz. - volume m<sup>3</sup> 0,15 Peso kg. 10**Articolo dotato di codice a barre**

## art. 427A



CE



Cintino sottogola regolabile per elmetto

**Packing:** 1 pezzo**Imballo minimo per ordine:** 10 pz.**Scatola:** 50 pz. - volume m<sup>3</sup> 0,05 Peso kg. 3**Articolo dotato di codice a barre**

8 011818 128697

## art. 717L



CE



8 011818 171501

Lampada frontale a led (batterie non incluse)

**Imballo minimo per ordine:** 10 pz.

**Packaging:** 1 pz

**Volume scatola:** 0,05 m<sup>3</sup> (10 pz.) Peso kg. 2

**Articolo dotato di codice a barre**



## art. 715L



CE



8 011818 109986



Lampada frontale con set carica batteria - Durata batteria circa 10 mesi. La luce può raggiungere una distanza di circa 80 metri.

Lampadine da 6W o 7W

**Packing:** 1 pezzo

**Imballo minimo per ordine:** 1 pezzo

**Scatola:** 1 pezzo - volume m<sup>3</sup> 0,03 - Peso Kg. 1

**Articolo dotato di codice a barre**

## art. 716L



CE



8 011818 109979



Lampada frontale utilizzabile con batterie a stilo (batterie non comprese - 4x1,5 volt).

**Packing:** 12 pezzi

**Imballo minimo per ordine:** 12 pezzi

**Scatola:** 12 pezzi - volume m<sup>3</sup> 0,05 - Peso Kg. 5

**Articolo dotato di codice a barre**





## art. 176



8 011818 095791

Visiera trasparente con supporto frontale

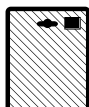
**Applicazione:** Edilizia, Agricoltura**Packing:** 10 pezzi**Imballo minimo per ordine:** 10 pz**Scatola:** 10 pz - volume m<sup>3</sup> 0,05 - Peso Kg. 5**Articolo dotato di codice a barre e confezione appendibile**

## art. 177



8 011818 095807

Visiera in rete con supporto frontale

**Applicazione:** Edilizia, Agricoltura**Packing:** 10 pezzi**Imballo minimo per ordine:** 10 pz**Scatola:** 10 pz - volume m<sup>3</sup> 0,05 - Peso Kg. 5**Articolo dotato di codice a barre e confezione appendibile**

## art. 431CE

[EN 166]



8 011818 095760

Caschetto con visiera trasparente regolabile

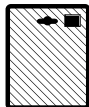
**Applicazione:** Edilizia-Agricoltura**Packing:** 1 pz.**Imballo minimo per ordine:** 1 pz.**Scatola:** 1 pz. - volume m<sup>3</sup> 0,03 - peso kg. 1**Articolo dotato di codice a barre e confezione appendibile**

## art. 431R

[EN 166]



8 011818 109955

Visiera a rete con caschetto

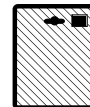
**Applicazione:** Edilizia - Forestale - Agricoltura**Packing:** 1 pz.**Imballo minimo per ordine:** 1 pz.**Scatola:** 10 pz. - volume m<sup>3</sup> 0,03 - peso kg. 1**Articolo dotato di codice a barre e confezione appendibile**

## art. 431V

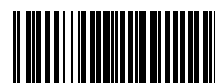

8 011818 149111



Visiera di ricambio per art. 431CE

**Applicazione:** edilizia, agricoltura**Packing:** 1 pezzo**Imballo minimo per ordine:** 1 pezzo**Scatola:** 10 pezzi - volume m<sup>3</sup> 0,08 Kg.0,8**Articolo dotato di codice a barre e confezione appendibile**

art. 431A

[EN166 - EN352]

CE



8 011818 109931

Visiera in policarbonato + Cuffie antirumore

**Applicazione:** Edilizia-Agricoltura

**Packing:** 1 pezzo

**Imballo minimo per ordine:** 1 pezzo

**Scatola:** 1 pz - volume m<sup>3</sup> 0,03 - Peso Kg. 1,5

**Articolo dotato di codice a barre**

art. 431AR

[EN 1731 EN352]

CE



8 011818 109948

Visiera in rete + Cuffie antirumore

**Applicazione:** Edilizia-Agricoltura

**Packing:** 1 pezzo

**Imballo minimo per ordine:** 1 pezzo

**Scatola:** 1 pz - volume m<sup>3</sup> 0,03 - Peso Kg. 1,5

**Articolo dotato di codice a barre**

art. 428

[EN 397 EN 352]

CE



8 011818 095692

Elmetto con cuffia antirumore

**Applicazione:** Edilizia - Agricoltura

**Packing:** 1 pz.

**Imballo minimo per ordine:** 1 pz.

**Scatola:** 1 pz. - volume m<sup>3</sup> 0,03 - peso kg. 1,2

**Articolo dotato di codice a barre**



art. 429

[EN397 - EN352 - EN166]

CE



8 011818 095722

Elmetto con cuffia antirumore e visiera

**Applicazione:** Edilizia - Agricoltura

**Packing:** 1 pz.

**Imballo minimo per ordine:** 1 pz.

**Scatola:** 1 pz. - volume m<sup>3</sup> 0,03 - peso kg. 1,5

**Articolo dotato di codice a barre**



art. 430

[EN 352-3 EN397  
EN1731:1997]

CE



8 011818 095708

Casco di sicurezza completo di cuffie e rete

**Applicazione:** Edilizia - Forestale

**Packing:** 1 pz.

**Imballo minimo per ordine:** 1 pz.

**Scatola:** 1 pz. - volume m<sup>3</sup> 0,03 - peso kg. 1

**Articolo dotato di codice a barre**



art. 419A

[EN 352-1 SNR 28,5 dB]



Cuffia antirumore pieghevole

**Applicazione:** industria, edilizia, agricoltura

**Packing:** 10 pezzi

**Imballo minimo per ordine:** 10 pz.

**Scatola:** 10 pz. - volume m<sup>3</sup> 0,10 - Peso kg. 7

**Articolo dotato di codice a barre e confezione appendibile**



8 011818 095968

art. 707

[EN 352-1 SNR 23 dB]



Cuffia antirumore – rossa SNR 23 dB

**Applicazione:** industria, edilizia, agricoltura

**Packing:** 1 pezzo

**Imballo minimo per ordine:** 1 pz.

**Scatola:** 20 pz. - volume m<sup>3</sup> 0,10 - Peso kg. 10

**Articolo dotato di codice a barre e confezione appendibile**



8 011818 112023

art. 708

[EN 352-1 SNR 23 dB]



Cuffia antirumore – blu SNR 23 dB

**Applicazione:** industria, edilizia, agricoltura

**Packing:** 1 pezzo

**Imballo minimo per ordine:** 1 pz.

**Scatola:** 20 pz. - volume m<sup>3</sup> 0,10 - Peso kg. 10

**Articolo dotato di codice a barre e confezione appendibile**



8 011818 112016

art. 114

[EN 352-1 SNR 25,7 dB]



Cuffia antirumore in polipropilene

**Applicazione:** industria, edilizia, agricoltura

**Packing:** 10 pezzi

**Imballo minimo per ordine:** 10 pz.

**Scatola:** 10 pz. - volume m<sup>3</sup> 0,07 - Peso kg. 7

**Articolo dotato di codice a barre e confezione appendibile**



8 011818 095784

art. 710T

[EN 352-2 SNR 37 dB]



5



Inseri auricolari monouso c/packing appendibile (conf. da 5 paia)

**Applicazione:** industria - agricoltura

**Packing:** 20 confezioni

**Imballo minimo per ordine:** 20 conf. da 5 paia

**Scatola:** 20 conf. - volume m<sup>3</sup> 0,08 Peso kg. 1,5

**Articolo dotato di codice a barre e confezione appendibile**



SEBA

art. 710QB4

[EN 352-2  
SNR 19 dB]

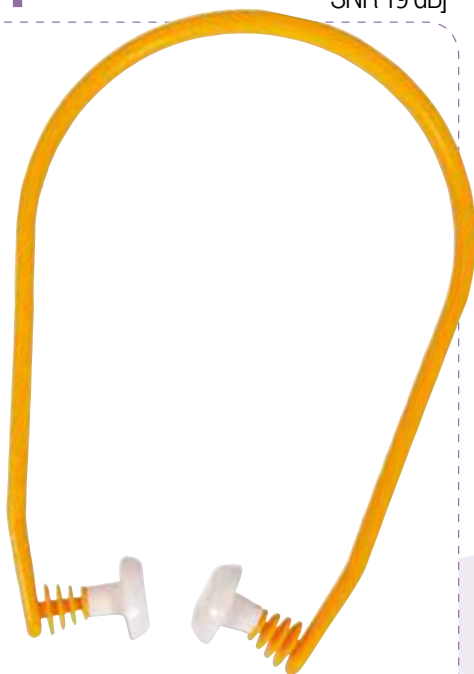

Inseri auricolari  
con archetto con packing appendibile

**Applicazione:** visitatori

**Packing:** 10 pezzi

**Imballo minimo per ordine:** 10 pz.

**Scatola:** 10 pz. - volume m<sup>3</sup> 0,08 Peso kg. 1,5

**Articolo dotato di codice a barre e confezione appendibile**

art. 1238

[EN 352-2  
SNR 21 dB]



5



Insero auricolare giallo con cordicella

**Applicazione :** industria in genere.

**Imballo minimo per ordine:** 1 pz

**Volume scatola:** 0,08 m<sup>3</sup> - 20 pezzi

peso kg. 9

**Articolo dotato di codice a barre e confezione appendibile.**

OCCHIALI



PROTEZIONE  
OCCHI

## PROTEZIONE DELLA VISTA

E' importante conoscere le caratteristiche e il funzionamento dell'occhio per capire quali agenti possono danneggiarlo e quali tipi di dispositivi di sicurezza debbano essere usati per proteggerlo.

L'occhio funziona come un sensore per il corpo umano che ci permette di percepire la luce visibile. La luce entra attraverso il cristallino per proiettarsi sulla retina, la parte interna e posteriore del bulbo oculare. Da qui i nervi ottici prendono l'immagine e la inviano al cervello che la decodifica in un messaggio visivo. L'intero bulbo oculare forma la parte più tenera del corpo umano e per i 5/6 posteriori non è visibile, ben protetto da ossa, muscoli, eccetera.

Il sesto anteriore è rivestito dalla cornea ed è la parte più esterna e meno protetta del nostro occhio. Ne consegue che diventa fondamentale proteggere quella sesta parte di occhio a noi visibile in quanto, oltre ad essere esposto al rischio di danni per la vista dell'individuo, è anche l'unica via che porta direttamente al cervello. Questa struttura fragile che ci permette di vedere è minacciata fundamentalmente da tre categorie a rischio:

### TIPO DI RISCHIO:

- 1) **MECCANICO:** urti con parti solide, polveri
- 2) **CHIMICO:** sostanze chimiche
- 3) **LUMINOSO RADIAZIONI:** UV, Infrarossi, Visibile, Laser.

A seconda dei risultati emersi dalla valutazione dei rischi, il datore di lavoro dovrà fornire dei protettori oculari rispondenti ai requisiti di sicurezza CEE definiti dalla normativa europea UNI EN 166 la quale definisce, come da art. 4.1, che il protettore oculare deve provvedere protezione contro:

- 1) impatti di diversa entità
- 2) radiazioni ottiche
- 3) metallo fuso e particelle incandescenti
- 4) spruzzi e gocce
- 5) polveri
- 6) gocce
- 7) archi elettrici

### E DEFINISCE POI CON L'ART. 4.2 I TIPI DI PROTETTORI OCULATORI:

- 1) occhiali a stanghetta con o senza ripari laterali
- 2) occhiali a mascherina
- 3) visiere
- 4) schermi
- 5) elmetti per saldatura.

Il protettore oculare deve essere marcato sia sulla lente sia sulla montatura. Per gli occhiali a mascherina la marcatura viene effettuata sulla montatura. Per le visiere deve essere presente sulla struttura reggente. La marcatura può essere composta da 7 campi:

- 1°) il primo numero indica il tipo di protezione luminosa (esempio: 2=filtro per UV, 3=filtro per UV senza alterazione dei colori, 5=filtro solare, 6=filtro solare e infrarossi). Il secondo numero staccato da un trattino corrisponde alla gradazione (un solo numero: gradazione di un protettore per saldatura).
- 2°) marchio del produttore.
- 3°) classe ottica: indica il grado di neutralità ottica dell'oculare.
- 4°) resistenza meccanica: S=robustezza incrementata, F=protezione impatto a bassa energia 162 km/h, B=protezione impatto a media energia 432 km/h (occhiali a mascherina e visiere), A=protezione impatto ad alta energia 684 km/h (solo visiere).
- 5°) campi di utilizzo: 3=liquidi, 4=particelle grossolane, 5=gas, 8=archi elettrici, 9=metalli fusi.
- 6°) lettera K se il protettore oculare è resistente alle abrasioni.
- 7°) lettera N se il protettore oculare è antiappannante.

E' importante verificare le caratteristiche dell'ambiente di lavoro e dell'attività lavorativa per individuare un protettore oculare che abbia un buon indice di confortevolezza.

TIPO DI RISCHIO		
MECCANICO	CHIMICO	LUMINOSO RADIAZIONI
Urti con parti solide polveri	Sostanze chimiche	UV - Infrarossi - Visibile - Laser

## LA MARCATURA

Il protettore oculare deve essere marcato sia sulla lente sia sulla montatura. Per gli occhiali a mascherina la marcatura viene effettuata sulla montatura. Per le visiere deve essere presente sulla struttura reggente.

## ESEMPIO DI MARCATURA

Il 1° numero corrisponde al tipo di protezione luminosa  
 2 = filtro per UV  
 3 = filtro per UV senza alterazione dei colori  
 5 = filtro solare  
 6 = filtro solare + IR  
 Il 2° numero staccato da un trattino è la gradazione .  
 Un solo numero: gradazione di un protettore per saldatura

Resistenza meccanica  
 S = robustezza incrementata  
 F = protezione impatto a bassa energia 162 Km/h  
 B = protezione impatto a media energia 432 Km/h (occhiali a mascherina e visiere)  
 A = protezione impatto ad alta energia 684 Km/h (solo visiere)

AOS = marchio del produttore

K = antiabrasione

5	AOS	1	F	3	K	N
---	-----	---	---	---	---	---

1 = classe ottica - indica il grado di neutralità dell'oculare

N = antiappannante

3 = campi di utilizzo (3 = liquidi; 4 = particelle grossolane; 5 = gas; 8 = archi elettrici; 9 = metalli fusi)

Infine, è importante verificare le caratteristiche dell'ambiente di lavoro e dell'attività lavorativa per individuare un protettore oculare che abbia un buon indice di confortevolezza.



art. 226C

[EN 166 ]

CE



8 011818 163445

Occhiale extra strong con lenti trasparenti. Elastico sganciabile. Spugna interna per un miglior comfort. Protezione raggi UV 99,9 %.

Antiappannamento.

**Applicazione:** industria chimica, edilizia, meccanica.

**Packing:** 1 pezzo

**Imballo minimo per ordine :** 12 pz.

**Scatola:** 12 pz - volume m<sup>3</sup> 0,08. Peso kg. 1,20



art. 226G

[EN 166 ]

CE



8 011818 163452

Occhiale extra strong con lenti color grigio. Elastico sganciabile. Spugna interna per un miglior comfort.

Protezione raggi UV 99,9 %.

Antiappannamento.

**Applicazione:** industria chimica, edilizia, meccanica.

**Packing:** 1 pezzo

**Imballo minimo per ordine :** 12 pz.

**Scatola:** 12 pz - volume m<sup>3</sup> 0,08. Peso kg. 1,20



art. 222C

[EN 166 - EN170]

CE



8 011818 127089

Occhiale con lenti in policarbonato. Stanghette regolabili. Protezione UV - Anti urto.

**Applicazione:** Industria - Edilizia

**Packing:** 1 pezzo

**Imballo minimo per ordine:** 12 pz.

**Scatola:** 12 pz. - volume m<sup>3</sup> 0,08. Peso Kg. 1,20

**Articolo dotato di codice a barre e blister appendibile**





art. 223A

[EN 166-EN170]



8 011818 127119

Occhiale con lenti in policarbonato azzurre.  
Stanghette regolabili - Protezione UV

**Applicazione:** edilizia, officina

**Packing:** 1 pezzo

**Imballo minimo per ordine:** 12 pz.

**Scatola:** 12 pz. - volume m<sup>3</sup> 0,08 Peso Kg. 1,20

**Articolo dotato di codice a barre e blister appendibile**



art. 223C

[EN 166-EN170]



8 011818 131680

Occhiale con lenti in policarbonato trasparenti.

Stanghette regolabili

Protezione UV

**Applicazione:** edilizia, officina

**Packing:** 1 pezzo

**Imballo minimo per ordine:** 12 pz.

**Scatola:** 12 pz. - volume m<sup>3</sup> 0,08 Peso Kg. 1,20

**Articolo dotato di codice a barre e blister appendibile**



art. 223GS

[EN 166-EN 170  
EN 172]



8 011818 127065

Occhiale con lenti in policarbonato grigio 5-2,5.

Stanghette regolabili - Protezione UV

**Applicazione:** edilizia, officina **Packing:** 1 pezzo

**Imballo minimo per ordine:** 12 pz.

**Scatola:** 12 pz. - volume m<sup>3</sup> 0,08 Peso Kg. 1,20

**Articolo dotato di codice a barre e blister appendibile**



art. 224BL

[EN 166 EN 170  
EN 172]

CE



8 011818 132922

Occhiale in nickel silver + policarbonato-pvc.  
Colore specchio blue 5 - 2,5. Resistenza UV supporto nasale

**Applicazione:** edilizia, officina

**Packing:** 1 pz.

**Imballo minimo per ordine:** 12 pz.

**Scatola:** 12 pz. - volume m<sup>3</sup> 0,08 Peso Kg. 1,20

**Articolo dotato di codice a barre e blister appendibile**



art. 224C

[EN 166 EN 170]

CE



8 011818 125320

Occhiale in nickel silver + policarbonato-pvc.

Resistenza UV -supporto nasale

**Applicazione:** edilizia, officina

**Packing:** 1 pz.

**Imballo minimo per ordine:** 12 pz.

**Scatola:** 12 pz. - volume m<sup>3</sup> 0,08 Peso Kg. 1,20

**Articolo dotato di codice a barre e blister appendibile**



art. 224G

[EN 166 EN 170  
EN 172]

CE



8 011818 132236

Occhiale in nickel silver + policarbonato-pvc.

Colore grigio 5 - 2,5 Resistenza UV - supporto nasale

**Applicazione:** edilizia, officina

**Packing:** 1 pezzo

**Imballo minimo per ordine:** 12 pz.

**Scatola:** 12 pz. - volume m<sup>3</sup> 0,08 Peso Kg. 1,20

**Articolo dotato di codice a barre e blister appendibile**



SEBA

## art. 225G

[EN 166 EN 170  
EN 172]

CE



8 011818 127041

Occhiale con lenti in policarbonato a specchio 5 - 3,1  
Stanghette regolabili Protezione UV

**Applicazione:** edilizia, officina

**Packing:** 1 pezzo

**Imballo minimo per ordine:** 12 pz.

**Scatola:** 12 pz - volume m<sup>3</sup> 0,08 - Peso Kg. 1,20

**Articolo dotato di codice a barre e blister appendibile**



## art. 227GL

[EN 166]

CE



8 011818 163483

Occhiale extra strong ultraleggero con schermo e stanghette  
color giallo. Protezione raggi UV 99%.

**Applicazione:** industria, edilizia.

**Packing:** 1 pezzo

**Imballo minimo per ordine :** 12 pz.

**Scatola:** 12 pz - volume m<sup>3</sup> 0,08. Peso kg. 1,20

**Articolo dotato di codice a barre e blister appendibile**



## art. 227G

[EN 166]

CE



8 011818 163476

Occhiale extra strong ultraleggero con schermo e  
stanghette color grigio. Protezione raggi UV 99%.

**Applicazione:** industria, edilizia.

**Packing:** 1 pezzo

**Imballo minimo per ordine :** 12 pz.

**Scatola:** 12 pz - volume m<sup>3</sup> 0,08. Peso kg. 1,20

**Articolo dotato di codice a barre e blister appendibile**



## 227C

[EN 166]

CE



8 011818 163469

Occhiale extra strong ultraleggero con schermo e  
stanghette trasparenti. Protezione raggi UV 99%.

**Applicazione:** industria, edilizia.

**Packing:** 1 pezzo

**Imballo minimo per ordine :** 12 pz.

**Scatola:** 12 pz - volume m<sup>3</sup> 0,08. Peso kg. 1,20

**Articolo dotato di codice a barre e blister appendibile**



art. 207

[EN 166 ]

CE



8 011818 095944

Occhiale con schermo in policarbonato, qualità antiurto.

Sovrapponibile a occhiali da vista

**Applicazione:** industria - laboratori

**Packing:** 1 pezzo

**Imballo minimo per ordine:** 10 pz.

**Scatola:** 10 pz. - volume m<sup>3</sup> 0,08 - Peso Kg. 1,50

Articolo dotato di codice a barre e confezione appendibile



art. 207N

[EN 166 ]

CE



8 011818 095883

Occhiale con schermo in policarbonato

c/stanghette regolabili, qualità antiurto.

Sovrapponibile a occhiali da vista

**Applicazione:** industria - laboratori

**Packing:** 1 pezzo

**Imballo minimo per ordine:** 10 pz.

**Scatola:** 10 pz. - volume m<sup>3</sup> 0,08 - Peso Kg. 1,50

Articolo dotato di codice a barre e confezione appendibile



art. 210N

[EN 166-SF  
Classe ottica 1 ]

CE



8 011818 095845

Occhiale a mascherina con fori di aerazione

**Applicazione:** industria - laboratori - agricoltura

**Packing:** 1 pezzo

**Imballo minimo per ordine:** 20 pz.

**Scatola:** 20 pz. - volume m<sup>3</sup> 0,08 - Peso Kg. 1,50

Articolo dotato di codice a barre e confezione appendibile



art. 220N

[EN 166-SF  
Classe ottica 1 ]

CE



8 011818 095852

Occhiale antiappannante. Classe ottica 1, con valvole di aerazione.

**Applicazione:** industria - laboratori - agricoltura

**Packing:** 1 pezzo

**Imballo minimo per ordine:** 20 pz.

**Scatola:** 20 pz. - volume m<sup>3</sup> 0,08 - Peso Kg. 1,50

Articolo dotato di codice a barre e confezione appendibile



art. 432

[EN 166 S ]

CE



8 011818 126785

Occhiali a mascherina per uso forestale, flessibile con rete in materiale plastico

**Applicazione:** forestale

**Packing:** 20 pezzi

**Imballo minimo per ordine:** 20 pz.

**Scatola:** 20 pz. - volume m<sup>3</sup> 0,08 - Peso Kg. 1,50

Articolo dotato di codice a barre e confezione appendibile





**FACCIALI  
FILTRANTI**



**MASCHERE**

## PROTEZIONE DELLE VIE RESPIRATORIE

Il corpo umano può ricevere danni sia per un'insufficienza di ossigeno nell'aria da respirare, sia per la presenza in essa di sostanze pericolose.

Un'insufficienza di ossigeno può causare un danno irreversibile alle cellule cerebrali ed anche la morte. Se il corpo assorbe sostanze pericolose, secondo il modo specifico in cui le sostanze agiscono (azione fisica, chimica o combinata), possono aversi malattie polmonari, intossicazioni acute o croniche, lesioni da radiazioni, tipi diversi di tumori o altri tipi di danni (per esempio allergie). L'entità del danno dipende generalmente dalla concentrazione e dalla durata dell'effetto della sostanza pericolosa alla salute, dalla via per la quale essa agisce con il corpo (per esempio deposizione nei polmoni, assorbimento nel sangue), dall'affaticamento dovuto al lavoro svolto, dalla frequenza e dal volume di respirazione nonché dalla specifica condizione fisica della persona.

Per ovviare a questi problemi si può ricorrere all'utilizzo degli apparecchi di protezione delle vie respiratorie (APVR). Prima di prendere in considerazione l'utilizzo di un APVR, deve esser attuato per quanto ragionevolmente fattibile "in relazione alle conoscenze acquisite in base al progresso tecnico", il contenimento degli inquinanti in sospensione nell'aria con il ricorso a metodi ingegneristici in uso (per esempio sistemi di confinamento, impianti di aspirazione). Se tale obiettivo non può essere raggiunto o se, per mezzo di misure tecniche od organizzative, esso può essere raggiunto soltanto in modo insufficiente, è allora opportuno rendere disponibili, per ogni singolo scopo specifico, gli idonei APVR e assicurarne in modo appropriato l'uso, l'immagazzinamento e la manutenzione. E' importante scegliere il tipo corretto di APVR fra i molti disponibili e conformi ai requisiti delle specifiche norme. L'uso di un tipo errato può essere pericoloso. E' altresì importante che tutte le persone, per le quali si rende necessario il ricorso ad un APVR, siano adeguatamente addestrate, istruite al suo uso ed eventualmente sottoposte ad esame medico. Il funzionamento di un APVR consiste o nel filtrare l'atmosfera inquinata o nel fornire aria respirabile da una sorgente alternativa. L'aria raggiunge l'utilizzatore tramite un boccaglio, una semimaschera intera, un elmetto, un cappuccio. Le fonti di rischio per le vie respiratorie sono: l'insufficienza di ossigeno, le temperature estreme e la presenza di sostanze contaminanti nell'aria ambiente.

I contaminanti sono così suddivisi:

- 1) polveri: particelle fini generate dalla frantumazione di materiali solidi;
- 2) nebbie: minuscole goccioline liquide a base organica o a base acqua che si creano da operazioni di spruzzo;
- 3) fumi: particelle solide molto fini, si formano quando si fonde o vaporizza un metallo che si raffredda velocemente;
- 4) gas: sostanze in fase aeriforme a pressione e a temperatura ambiente;
- 5) vapori: forma gassosa di sostanze che, a temperatura ambiente, si trovano allo stato liquido o solido.

### RESPIRATORI SENZA MANUTENZIONE PER POLVERI - DEFINIZIONI TECNICHE

Tipo e classe

Un simbolo che indica il tipo di dispositivo ed il livello di protezione offerto, ad esempio FFP2: respiratore per polveri a facciale filtrante di classe 2 dove classe 2 indica il livello di protezione.

Livello massimo di utilizzo

Quantità massima di contaminante nell'aria per la quale si può utilizzare il respiratore; il dato è di solito espresso come multiplo della concentrazione accettabile sul luogo di lavoro.

TLV (Threshold Limit Value o Valore Limite di Soglia)

La concentrazione media ponderata nel tempo (considerando un giorno lavorativo medio di 8 ore e una settimana lavorativa di 40 ore) alla quale si ritiene che quasi tutti i lavoratori possano essere esposti continuamente giorno dopo giorno, senza effetti nocivi per la salute; si misura in milligrammi per metro cubo per le polveri e in parti per milione per i gas e i vapori.

### ELENCO NORME PER LE VIE RESPIRATORIE:

- UNI EN 132:2000** Apparecchi di protezione delle vie respiratorie - Definizioni dei termini e dei pittogrammi
- UNI EN 134:2000** Apparecchi di protezione delle vie respiratorie - Nomenclatura dei componenti
- UNI EN 136:2000** Apparecchi di protezione delle vie respiratorie - Maschere intere - Requisiti, prove, marcatura
- UNI EN 140:2000** Apparecchi di protezione delle vie respiratorie - Semimaschere e quarti di maschera - Requisiti, prove, marcatura
- UNI EN 14387:2004** Apparecchi di protezione delle vie respiratorie - Filtri antigas e combinati - Requisiti, prove, marcatura
- UNI EN 143:2002** Apparecchi di protezione delle vie respiratorie - Filtri antipolvere - Requisiti, prove, marcatura
- UNI EN 149:2003** Apparecchi di protezione delle vie respiratorie - Semimaschera filtrante contro particelle - Requisiti, prove, marcatura

### MARCATURA DEI FILTRI

Filtri antipolvere (idonei per la protezione da polveri e fibre, fumi e nebbie)

Le norme europee UNI EN149:2003 (per i filtranti facciali antipolvere) e UNI EN 143:2002 (per i filtri antipolvere delle maschere in gomma) definiscono tre diverse classi di protezione ad efficienza filtrante totale crescente:

- 1° Filtri di tipo P1:** per protezione da aerosol non tossici (polveri) in concentrazioni fino a 4 volte il TLV (Valore Limite di Soglia).
  - 2° Filtri di tipo P2:** per protezione da aerosol a bassa/media tossicità (particelle) in concentrazioni fino a 10 volte il TLV (16 x TLV se montati su pieno facciale).
  - 3° Filtri di tipo P3:** per protezione da aerosol a bassa/media/alta tossicità e aerosol radioattivi (particelle) in concentrazioni fino a 30 volte il TLV (200 x TLV se montati su pieno facciale).
- Filtri antigas** (idonei per la protezione da gas e vapori)  
La norma europea UNI EN 14387:2004 definisce varie tipologie di filtro:
- Tipo A:** filtro di colore marrone, per protezione da vapori organici con punto di ebollizione superiore ai 65 °C.
  - Tipo B:** filtro di colore grigio, per protezione da gas e vapori inorganici (esempio: cloro, acido cianidrico, acido solfidrico).
  - Tipo E:** filtro di colore giallo, per protezione da gas acidi (esempio: anidride solforosa, acido cloridrico).
  - Tipo K:** filtro di colore verde, per protezione da ammoniaca.

Per ogni tipologia di filtro antigas esistono tre classi di protezione, che si differenziano per la capacità, cioè la quantità di contaminante che il filtro è in grado di assorbire e quindi la durata (e non l'efficienza che è 100%).

- Classe 1:** filtro con bassa capacità e un limite di utilizzo pari a 1000 ppm.
- Classe 2:** filtro con media capacità e un limite di utilizzo pari a 5000 ppm.
- Classe 3:** filtro con alta capacità e un limite di utilizzo pari a 10000 ppm.

(ppm=parti per milione, ossia le parti del contaminante per milioni di parti d'aria)

## NORME EN PER LE VIE RESPIRATORIE

- EN 132: definizioni apparecchi
- EN 134: elenco dei componenti
- EN 136: maschere intere
- EN 140: semimaschere
- EN 14387: filtri antigas e combinati
- EN 143: filtri antipolvere
- EN 149: facciali filtranti antipolvere

## MARCATURA DEI FILTRI

TIPO	COLORE	CAMPO D'IMPIEGO
P1		Protezione da aerosol non tossici (polveri) in concentrazioni fino a 4x MAC/OEL/TLV
P2		Protezione da aerosol a bassa / media tossicità (particelle) in concentrazioni fino a 10 x MAC/OEL/TLV (16 x MAC/OEL/TLV se montati su pieno facciale)
P3		Protezione da aerosol a bassa / media / alta tossicità e aerosol radioattivi (particelle) in concentrazioni fino a 30 x MAC/OEL/TLV (200 x MAC/OEL/TLV se montati su pieno facciale)
A	marrone	vapori organici con punto di ebollizione >65°C
B	grigio	gas e vapori inorganici, es.: cloro, acido cianidrico, acido solfidrico
E	giallo	gas acidi es.: anidride solforosa, acido cloridrico
K	verde	ammoniaca
P	bianco	polveri



### art. 4H

NO DPI



8 011818 109924



Mascherina sanitaria a due veli c/elastico.

**Applicazione:** settore sanitario

**Packing:** 1000 pezzi

**Imballo minimo per ordine:** 1000 pz.

**Scatola:** 1000 pezzi - volume m<sup>3</sup> 0,10

**Peso:** Kg. 6

**Articolo dotato di codice a barre**

### art. 4C

NO DPI



8 011818 106749



Mascherina igienica 10 pezzi appendibile

**(non è DPI)**

**Applicazione:** Previene la contaminazione del prodotto da parte dell'operatore durante la fase produttiva.

**Packing:** confezione appendibile da 10 pz.

**Imballo minimo per ordine:** 50 box da 10 pz.

**Scatola:** 500 pz. - volume m<sup>3</sup> 0,08. Peso Kg. 3,5

**Articolo dotato di codice a barre e confezione appendibile**

### art. 4

NO DPI



8 011818 104042



Mascherina igienica 50 pezzi (NON È DPI)

**Applicazione:** Previene la contaminazione del prodotto da parte dell'operatore durante la fase produttiva.

**Packing:** 50 pz.

**Imballo minimo per ordine:** 10 box da 50 pz.

**Scatola:** 10 box da 50 pz. - volume m<sup>3</sup> 0,08.

Peso Kg. 3,5

**Articolo dotato di codice a barre**

### art. 4F

[(FFP1) EN 149:2001 + A1:2009]

CE



8 011818 095982



Facciale filtrante FFP1, leggero e confortevole, indicato per polveri

**Applicazione:** industria

**Packing:** 20 pz

**Imballo minimo per ordine:** 240 pz.

**Scatola:** 240 pz. - volume m<sup>3</sup> 0,10. Peso Kg. 10

**Articolo dotato di codice a barre**

### art. 4FC

[(FFP1) EN 149:2001 + A1:2009]

CE



8 011818 107128



Facciale filtrante, confezione da 5 pz. appendibile

**Applicazione:** industria, magazzini

**Packing:** 4 conf. da 5 pz.

**Imballo minimo per ordine:** 240 pz.

**Scatola:** 240 pz. ( 48 conf. da 5 pz.) - volume m<sup>3</sup> 0,10. Peso Kg. 10

**Articolo dotato di codice a barre e confezione appendibile**

### art. 4A

[(FFP1) EN 149:2001 + A1:2009 + CARBON]

CE



8 011818 095777



Facciale filtrante, con carboni attivi, leggero e confortevole, indicato per polveri e fumi

**Applicazione:** industria

**Packing:** 20 pz

**Imballo minimo per ordine:** 240 pz.

**Scatola:** 240 pz. - volume m<sup>3</sup> 0,10. Peso Kg. 10

**Articolo dotato di codice a barre**



art. 4AB

[(FFP1) EN 149:2001 + A1:2009 + CARBON]



8 011818 095975



Facciale filtrante a carboni attivi, leggero e confortevole, con valvola di espirazione, indicato per polveri e fumi  
**Applicazione:** industria - edilizia  
**Packing:** 10 pz.  
**Imballo minimo per ordine:** 120 pz.  
**Scatola:** 120 pz. - volume m<sup>3</sup> 0,08. Peso Kg. 7  
**Articolo dotato di codice a barre**



art. 4G

[(FFP2) EN 149:2001 + A1:2009]



8 011818 095999



Facciale filtrante, leggero e confortevole, con valvola di espirazione, indicato per polveri  
**Applicazione:** industria - edilizia  
**Packing:** 10 pz.  
**Imballo minimo per ordine:** 120 pz.  
**Scatola:** 120 pz. - volume m<sup>3</sup> 0,10. Peso Kg. 10  
**Articolo dotato di codice a barre**

art. 4GLM

[(FFP2) EN 149:2001 + A1:2009]



8 011818 151695



Facciale filtrante, leggero e confortevole, con valvola di espirazione, indicato per polveri  
**Applicazione:** industria - edilizia  
**Packing:** 10 pz.  
**Imballo minimo per ordine:** 120 pz.  
**Scatola:** 120 pz. - volume m<sup>3</sup> 0,10. Peso Kg. 10  
**Articolo dotato di codice a barre e confezione appendibile.**

art. 4CAT

[(FFP2) + CARBON]



8 011818 170764



Facciale filtrante FFP2 con valvola e carboni attivi.  
**Applicazione:** industria - edilizia  
**Packing:** 10 pz.  
**Imballo minimo per ordine:** 120 pz.  
**Scatola:** 120 pz. - volume m<sup>3</sup> 0,10. Peso Kg. 10  
**Articolo dotato di codice a barre**

art. 4P

[(FFP2) EN 149:2001 + A1:2009]



8 011818 129595



Facciale filtrante pieghevole con valvola di espirazione FFP2. Imbustata singolarmente.  
**Applicazione:** industria  
**Packing:** 20 pz.  
**Imballo minimo per ordine:** 240 pz.  
**Scatola:** 240 pz - volume m<sup>3</sup> 0,10. Peso Kg. 10  
**Articolo dotato di codice a barre**

art. 4EP

[(FFP3) EN 149:2001 + A1:2009]



8 011818 165043



Mascherina pieghevole FFP3 con valvola. Imbustata singolarmente.  
**Applicazione:** industria  
**Packing:** 20 pz.  
**Imballo minimo per ordine:** 240 pz  
**Volume scatola:** 0,08 m3 - 240 pezzi  
 Peso kg. 8  
**Articolo dotato di codice a barre**

art. 4EC

[(FFP3) EN 149:2001 + A1:2009]



8 011818 164725



Mascherina a conchiglia FFP3 con valvola  
**Applicazione:** industria  
**Packing:** 20 pz.  
**Imballo minimo per ordine:** 120 pz  
**Volume scatola:** 0,08 m3 - 120 pezzi  
 Peso kg. 8  
**Articolo dotato di codice a barre**

art. 4E

[(FFP3) EN 149:2001 + A1:2009]



Facciale filtrante, leggero e confortevole, con elastici regolabili e valvola di espirazione. Indicato per polveri molto fini, amianto, etc. Imbustata singolarmente.

**Applicazione:** industria

**Packing:** 5 pz

**Imballo minimo per ordine:** 60 pz.

**Scatola:** 60 pz. - volume m<sup>3</sup> 0,10. Peso Kg. 10

**Articolo dotato di codice a barre e confezione appendibile**



SEBA

art. 4ES

[(FFP3 NRD) EN 149:2001 + A1:2009]



Mascherina FFP3 NRD con valvola. Imbustata singolarmente.  
**Applicazione** : industria, cantieri e lavori edili  
**Imballo minimo per ordine**: 10 pz  
**Volume scatola**: 0,08 m3 - 60 pezzi - peso kg. 6  
**Articolo dotato di codice a barre e confezione appendibile.**



art. 4ESC

[(FFP3 NRD) EN 149:2001 + A1:2009 + CARBON]]



Mascherina FFP3 NRD con valvola e carboni attivi. Imbustata singolarmente.  
**Applicazione** : industria, cantieri e lavori edili  
**Imballo minimo per ordine**: 10 pz  
**Volume scatola**: 0,08 m3 - 60 pezzi - peso kg. 6  
**Articolo dotato di codice a barre e confezione appendibile.**



art. 4261

[FFA2 P3 EN 149:2001 + A1:2009]



Facciale filtrante FFA2P3  
**Applicazione** : industria, cantieri e lavori edili, agricoltura/giardinaggio  
**Imballo minimo per ordine**: 1 pz  
**Volume scatola**: 0,08 m3 - 20 pezzi  
 Peso kg. 5  
**Articolo dotato di codice a barre e confezione appendibile.**



DISTRIBUTORE UFFICIALE



art. 424G

[EN 140]



8 011818 095319

Semimaschera in gomma sintetica a 2 Filtri ( da acquistare a parte )  
**Applicazione:** industria - edilizia - agricoltura  
**Packing:** 1 pezzo  
**Imballo minimo per ordine:** 1 pz.  
**Scatola:** 1 pz. - volume m<sup>3</sup> 0,03 - Peso Kg. 0,5  
**Articolo dotato di codice a barre**



art. 424

[EN 140]



8 011818 095081

Semimaschera a due filtri, mascherina oronasale in silicone anallergico, struttura rigida portante in polipropilene ad alta resistenza meccanica. Filtri esclusi.  
**Applicazione:** industria - edilizia - agricoltura  
**Packing:** 1 pezzo  
**Imballo minimo per ordine:** 1 pz.  
**Scatola:** 1 pz. - volume m<sup>3</sup> 0,03 - Peso Kg. 0,5  
**Articolo dotato di codice a barre**



art. 424A1P3

[EN 143]



8 011818 095104

FILTRI per articoli: 424G - 424



A2P3R

art. 424P3

[EN 143]



8 011818 095135

FILTRI per articoli: 424G - 424



P3R

art. 424ABEKP

[EN 143]



8 011818 095111

FILTRI per articoli: 424G - 424



A1B1E1K1P3R

art. 424A1

[EN 143]



8 011818 095098

FILTRI per articoli: 424G - 424



A2



DISTRIBUTORE UFFICIALE



## art. 426

[EN 148 - EN 136]

CE



8 011818 095142

Maschera pieno facciale integrale, visore in policarbonato trasparente ad alta resistenza meccanica. Guarnizione facciale a soffietto, elastico in morbido neoprene antiallergico. Oronasale anatomico e valvole di ispirazione in mescola siliconica, cinghiaggio a 6 capi, posizionamento ergonomico centrale dell'attacco del filtro, attacchi integrati. Filtro escluso.

**Applicazione:** industria, cantieri e lavori edili, agricoltura.

**Imballo minimo per ordine:** 1 pz

**Volume scatola:** 0,05 m<sup>3</sup> - 1 pezzo - peso kg. 3

**Articolo dotato di codice a barre.**



## art. 426AA1

[EN 148-1]



8 011818 095166

FILTRI per art. 426



A1

## art. 426AA1P3

[EN 148-1]



8 011818 095173

FILTRI per art. 426



A2P3

## art. 426ABEKP3

[EN 148-1]



8 011818 095159

FILTRI per art. 426



A2B2E2K2P3



art. 422

[EN 140]



8 011818 171044

Semimaschera a 2 filtri (non compresi)

**Applicazione:** industria, edilizia, agricoltura.

**Packing:** 1 pezzo

**Imballo minimo per ordine:** 10 pz

**Scatola:** 10 pz - volume m3 0,05 - Peso Kg. 5

**Articolo dotato di codice a barre e confezione appendibile**



art. 423L

[EN 140]



FILTRI NON COMPRESI



8 011818 171105

Semimaschera a 2 filtri (non compresi)

**Applicazione:** industria, edilizia, agricoltura.

**Packing:** 1 pezzo

**Imballo minimo per ordine:** 10 pz

**Scatola:** 10 pz - volume m3 0,05 - Peso Kg. 5

**Articolo dotato di codice a barre e confezione appendibile**



art. 423A1

[EN 143]



A1



8 011818 171051

FILTRO x  
ART.422 - 423L

art. 423A1E1

[EN 143]



A1E1



8 011818 171068

FILTRO x  
ART.422 - 423L

art. 423ABEK

[EN 143]



ABEK



8 011818 171075

FILTRO x  
ART.422 - 423L

art. 423P2

[EN 143]



P2



8 011818 171105

FILTRO x  
422 - 423L

art. 423G



8 011818 171082

art. 423P3



8 011818 171112

## Facciali Filtranti per polveri, fumi e nebbie

Respiratori extra comfort serie AURA 9300 a norma EN 149:2001 + A1:2009 + A1:2009 - Marcatura CE

## art. 9310-3M

[CE EN 149:2001 + A1:2009]



5 010027 790070

Respiratore per polveri - Classe FFP1 NRD

CPN: AURA 9310+

Applicazione: Industria - Edilizia - Agricoltura

Packing: 20 pz. per conf.

Imballo minimo per ordine: 60 pz.

Scatola: 240 pz. - volume m<sup>3</sup> 0,10 - peso Kg. 9

Articolo dotato di codice a barre

## art. 9312-3M

[CE EN 149:2001 + A1:2009]



8 011818 131277

Respiratore per polveri - Classe FFP1 NRD con valvola

CPN: AURA 9312+

Applicazione: Industria - Edilizia - Agricoltura

Packing: 10 pz. per conf.

Imballo minimo per ordine: 40 pz.

Scatola: 120 pz. - volume m<sup>3</sup> 0,10 - peso Kg. 9

Articolo dotato di codice a barre



DISTRIBUTORE UFFICIALE

3M

## art. 9320-3M

[CE EN 149:2001 + A1:2009]



8 011818 128253

Respiratore per polveri - Classe FFP2 NRD

CPN: AURA 9320+

Applicazione: Industria - Edilizia - Agricoltura

Packing: 20 pz. per conf.

Imballo minimo per ordine: 40 pz.

Scatola: 240 pz. - volume m<sup>3</sup> 0,10 - peso Kg. 9

Articolo dotato di codice a barre

## art. 9322-3M

[CE EN 149:2001 + A1:2009]



8 011818 128499

Respiratore per polveri - Classe FFP2 NRD con valvola

CPN: AURA 9322+

Applicazione: Industria - Edilizia - Agricoltura

Packing: 10 pz. per conf.

Imballo minimo per ordine: 60 pz.

Scatola: 120 pz. - volume m<sup>3</sup> 0,10 - peso Kg. 9

Articolo dotato di codice a barre

## art. 9332-3M

[CE EN 149:2001 + A1:2009]



5 010027 790223

Respiratore per polveri - Classe FFP3 NRD con valvola

CPN: AURA 9332+

Applicazione: Industria - Edilizia - Agricoltura

Packing: 10 pz. per conf.

Imballo minimo per ordine: 20 pz.

Scatola: 120 pz. - volume m<sup>3</sup> 0,10 - peso Kg. 9

Articolo dotato di codice a barre

Facciali Filtranti per polveri, fumi e nebbie

Respiratori a conchiglia serie 8000 a norma EN 149:2001 + A1:2009 - Marcatura CE



art. 8710-3M

[CE EN 149:2001 + A1:2009]



5 010027 750739

Respiratore per polveri - Classe FFP1

CPN: 8710E

Applicazione: Industria - Edilizia - Laboratori

Packing: 20 pz. per conf.

Imballo minimo per ordine: 120 pz.

Scatola: 240 pz. - volume m<sup>3</sup> 0,10 - peso Kg. 9

Articolo dotato di codice a barre

art. 8810-3M

[CE EN 149:2001 + A1:2009]



8 011818 131307

Respiratore per polveri - Classe FFP2 NRD

CPN: 8810

Applicazione: Industria chimica, meccanica, navale, del legno.

Packing: 20 pz. per conf.

Imballo minimo per ordine: 60 pz.

Scatola: 240 pz. - volume m<sup>3</sup> 0,10 - peso Kg. 9

Articolo dotato di codice a barre

art. 8812-3M

[CE EN 149:2001 + A1:2009]



5 010027 750616

Respiratore per polveri - Classe FFP1 NRD con valvola

CPN: 8812

Applicazione: Industria dei metalli, carteggiatura

Packing: 10 pz. per conf.

Imballo minimo per ordine: 60 pz.

Scatola: 240 pz. - volume m<sup>3</sup> 0,10 - peso Kg. 9

Articolo dotato di codice a barre

art. 8822-3M

[CE EN 149:2001 + A1:2009]



5 010027 750555

Respiratore per polveri - Classe FFP2 NRD con valvola

CPN: 8822

Applicazione: Industria - Agricoltura - Cantieri navali

Packing: 10 pz. per conf.

Imballo minimo per ordine: 60 pz.

Scatola: 240 pz. - volume m<sup>3</sup> 0,10 - peso Kg. 9

Articolo dotato di codice a barre

art. 8825-3M

[CE EN 149:2001 + A1:2009]



8 011818 131598

Respiratore per polveri - Classe FFP2RD con valvola

CPN: 8825

Applicazione: Industria - Edilizia - Cantieri navali

Packing: 5 pz. per conf.

Imballo minimo per ordine: 10 pz.

Scatola: 50 pz. - volume m<sup>3</sup> 0,10 - peso Kg. 9

Articolo dotato di codice a barre

art. 8833-3M

[CE EN 149:2001 + A1:2009]



8 011818 142709

Respiratore per polveri - Classe FFP3RD con valvola

CPN: 8833

Applicazione: Industria - Edilizia - Cantieri navali

Packing: 10 pz. per conf.

Imballo minimo per ordine: 20 pz.

Scatola: 80 pz. - volume m<sup>3</sup> 0,10 - peso Kg. 9

Articolo dotato di codice a barre





## Facciali Filtranti per polveri, fumi e nebbie

Respiratori a conchiglia serie 8000 a norma EN 149:2001 + A1:2009 - Marcatura CE

### art. 8835-3M

[CE EN 149:2001 + A1:2009]



5 010027 750319

Respiratore per polveri  
Classe FFP3RD con valvola.

**Taglie:** M/L

**CPN:** 8835

**Applicazione:** Industria - Edilizia - Cantieri navali

**Packing:** 5 pz. per conf.

**Imballo minimo per ordine:** 10 pz.

**Scatola:** 50 pz. - volume m<sup>3</sup> 0,10 - peso Kg. 9

**Articolo dotato di codice a barre**

### art. 9906-3M

[CE EN 149:2001 + A1:2009]



8 011818 148176

Respiratore per esalazioni acido fluoridrico in  
concentrazioni < TLV Classe FFP1

**CPN:** 9906

**Applicazione:** Industria chimica - laboratori - industria  
farmaceutica

**Packing:** 40 pz. per conf.

**Imballo minimo per ordine:** 100 pz.

**Scatola:** 100 pz. - volume m<sup>3</sup> 0,10 - Peso Kg.9

**Articolo dotato di codice a barre**

### art. 9913-3M

[CE EN 149:2001 + A1:2009]



8 011818 132823

Respiratore per odori fastidiosi e verniciatura a  
pennello in concentrazioni < TLV Classe FFP1

**CPN:** 9913

**Applicazione:** Industria chimica - laboratori -  
industria farmaceutica

**Packing:** 20 pz. per conf.

**Imballo minimo per ordine:** 40 pz.

**Scatola:** 100 pz. - volume m<sup>3</sup> 0,10 - Peso Kg.9

**Articolo dotato di codice a barre**

### art. 9914-3M

[CE EN 149:2001 + A1:2009]



8 011818 131642

Respiratore per odori fastidiosi e verniciatura a  
pennello in concentrazioni < TLV Classe FFP1 con  
valvola

**CPN:** 9914

**Applicazione:** Industria chimica - laboratori -  
industria farmaceutica

**Packing:** 10 pz. per conf.

**Imballo minimo per ordine:** 20 pz.

**Scatola:** 100 pz. - volume m<sup>3</sup> 0,10 - Peso Kg.9

**Articolo dotato di codice a barre**

### art. 9922-3M

[CE EN 149:2001 + A1:2009]



8 011818 148183

Respiratore per polveri ozono e vapori organici in  
concentrazione < TLV Classe FFP2 con valvola

**CPN:** 9922

**Applicazione:** Industria chimica - laboratori - industria  
farmaceutica

**Packing:** 40 pz. per conf.

**Imballo minimo per ordine:** 100 pz.

**Scatola:** 100 pz. - volume m<sup>3</sup> 0,10 - Peso Kg.9

**Articolo dotato di codice a barre**

### art. 9926-3M

[CE EN 149:2001 + A1:2009]



8 011818 131253

Respiratore per gas acidi e cloro in concentrazione <  
TLV Classe FFP2 con valvola

**CPN:** 9926

**Applicazione:** Industria chimica - laboratori -  
industria farmaceutica

**Packing:** 10 pz. per conf.

**Imballo minimo per ordine:** 20 pz.

**Scatola:** 100 pz. - volume m<sup>3</sup> 0,10 - Peso Kg.9

**Articolo dotato di codice a barre**



**Facciali filtranti per polveri, fumi da saldatura**

Respiratori speciali serie 9000 a norma EN 149:2001 + A1:2009 - Marcatura CE

**art. 9925-3M**

[CE EN 149:2001 + A1:2009]



Respiratore per polveri, fumi di saldatura e ozono - Classe FFP2 con valvola  
**CPN:** 9925

**Applicazione:** Saldatura - fonderie - cantieri navali - meccanica

**Packing:** 10 pz. per conf. - **Imballo minimo per ordine:** 40 pz.

**Scatola:** 80 pz. - volume m<sup>3</sup> 0,10 - Peso Kg.9

**Articolo dotato di codice a barre**

**art. 9928-3M**

[CE EN 149:2001 + A1:2009]



Respiratore per polveri, fumi di saldatura di metalli pesanti e ozono, classe FFP2RD con valvola - **CPN:** 9928

**Applicazione:** Saldatura - fonderie - cantieri navali - meccanica

**Packing:** 10 pz. per conf. - **Imballo minimo per ordine:** 40 pz.

**Scatola:** 80 pz. - volume m<sup>3</sup> 0,10 - Peso Kg.9

**Articolo dotato di codice a barre**

**Facciali filtranti per gas, vapori e polveri**

Respiratori serie 4000 a norma EN 405:2001 + A1:2009 - Marcatura CE

**art. 4251-3M**

[CE EN 405:2001 + A1:2009]



Respiratore per vapori organici + polveri - Classe FFA1P2RD - **CPN:** 4251

**Applicazione:** Verniciatura, acido acetico, dilimone, solventi organici

**Packing:** 1 pz. per conf. -

**Imballo minimo per ordine:** 10 pz.

**Scatola:** 10 pz. - volume m<sup>3</sup> 0,08 - Peso Kg.6

**Articolo dotato di codice a barre**

**art. 4277-3M**

[CE EN 405:2001 - A1:2009]

Respiratore per vapori organici, gas/ vapori inorganici, gas acidi+polveri Classe FFABE1P3RD **CPN:** 4277

**Applicazione:** Decapaggio, pulizia con acidi, incisione metalli, uso solventi organici.

**Packing:** 1 pz. per conf.

**Imballo minimo per ordine:** 10 pz.

**Scatola:** 10 pz. - volume m<sup>3</sup> 0,08 - Peso Kg.9

**Articolo dotato di codice a barre**



**art. 4255-3M**

[CE EN 405:2001 - A1:2009]

Respiratore per vapori organici + polveri - Classe FFA2P3RD

**CPN:** 4255 **Applicazione:** Glutaraldeide, acido acetico, dilimone, solventi organici

**Packing:** 1 pz. per conf.

**Imballo minimo per ordine:** 10 pz.

**Scatola:** 10 pz. - volume m<sup>3</sup> 0,08 - Peso Kg.6

**Articolo dotato di codice a barre**



**art. 4279-3M**

[CE EN 405:2001 - A1:2009]

Respiratore per vapori organici, gas/ vapori inorganici, gas acidi e ammoniac/ metilamina + polveri

Classe FFABEK1P3RD **CPN:** 4279

**Applicazione:** Produzione e manutenzione di impianti refrigeranti, pulizia con acidi, incisione metalli, uso solventi organici

**Packing:** 1 pz. per conf.

**Imballo minimo per ordine:** 10 pz.

**Scatola:** 10 pz. - volume m<sup>3</sup> 0,08 - Peso Kg.6

**Articolo dotato di codice a barre**



**Semimaschere Serie 6000 - A due filtri con innesto a baionetta**

[CE EN 140:1998 - EN14387:2004 + A1:2008]

**art. 6300-3M**

Facciale a semimaschera mis. grande

**CPN:** 6300

**Packing:** 1 pz. per conf.

**Imballo minimo per ordine:** 8 pz.

**Scatola:** 8 pz. volume m<sup>3</sup> 0,08 - Peso kg. 5

**Articolo dotato di codice a barre**



FILTRI A PARTE A PAG. SUCCESSIVE



**art. 6200-3M**

Facciale a semimaschera mis. media

**CPN:** 6200

**Packing:** 1 pz. per conf.

**Imballo minimo per ordine:** 8 pz.

**Scatola:** 8 pz. volume m<sup>3</sup> 0,08 - Peso kg. 5

**Articolo dotato di codice a barre**



FILTRI A PARTE A PAG. SUCCESSIVE



## Maschere pieno facciale in gomma siliconica - Serie 6000

A due filtri con innesto a baionetta a norma EN 136 Classe I - Marcatura CE



FILTRI A  
PARTE A PAG.  
SUCCESSIVE



### art. 6900S-3M

[CE EN 136 Classe I + EN166:2001  
+ EN14387:2004 + A1:2008]



8 011818 127508

Maschera a pieno facciale in gomma siliconica misura grande. **CPN:** 6900S

**Packing:** 1 pz. per conf.

**Imballo minimo per ordine:** 1 pz.

**Scatola:** 4 pz. - volume m<sup>3</sup> 0,08 - Peso kg. 4

**Articolo dotato di codice a barre**



### art. 6800S-3M

[CE EN 136 Classe I + EN166:2001  
+ EN14387:2004 + A1:2008]



8 011818 127492

Maschera a pieno facciale in gomma siliconica misura media. **CPN:** 6800S

**Packing:** 1 pz. per conf.

**Imballo minimo per ordine:** 1 pz.

**Scatola:** 4 pz. - volume m<sup>3</sup> 0,08 - Peso kg. 9

**Articolo dotato di codice a barre**



## Semimaschere in gomma siliconica Serie 7500

A due filtri con innesto a baionetta a norma EN 136 Classe I - Marcatura CE

### art. 7501-3M

[CE EN 140:1998]



8 011818 148206

Facciale a semimaschera misura piccola.

**CPN:** 7501

**Packing:** 1 pz. per conf.

**Imballo minimo per ordine:** 10 pz.

**Scatola:** 10 pz. - volume m<sup>3</sup> 0,08 - Peso kg. 4

**Articolo dotato di codice a barre**



FILTRI A  
PARTE A PAG.  
SUCCESSIVE



### art. 7502-3M

[CE EN 140:1998]



8 011818 128543

Facciale a semimaschera misura media.

**CPN:** 7502

**Packing:** 1 pz. per conf.

**Imballo minimo per ordine:** 10 pz.

**Scatola:** 10 pz. - volume m<sup>3</sup> 0,08 - Peso kg. 4

**Articolo dotato di codice a barre**

FILTRI A  
PARTE A PAG.  
SUCCESSIVE



### art. 7503-3M

[CE EN 140:1998]



8 011818 132151

Facciale e semimaschera misura grande.

**CPN:** 7503

**Packing:** 1 pz. per conf.

**Imballo minimo per ordine:** 10 pz.

**Scatola:** 10 pz. - volume m<sup>3</sup> 0,08 - Peso kg. 4

**Articolo dotato di codice a barre**

FILTRI A  
PARTE A PAG.  
SUCCESSIVE



**Filtri per polveri, fumi e nebbie - FILTRI SERIE 2000 ad innesto diretto**

Per semimaschere e pieni facciali serie 6000/7000 a norma EN 143:2000 - A1 - Marcatura CE



**art. 2125-3M**

[CE EN 143.2000 - A1:2006]

Filtro per polveri Classe P2

**CPN:** 2125

**Packing:** 40 pz. per conf.

**Imballo minimo per ordine:** 80 pz.

**Scatola:** 80 pz. - volume m<sup>3</sup> 0,08

**Peso kg. 4**

**Articolo dotato di codice a barre**



**art. 2135-3M**

[CE EN 143.2000 - A1]

Filtro per polveri Classe P3

**CPN:** 2135

**Packing:** 10 pz. per conf.

**Imballo minimo per ordine:** 40 pz.

**Scatola:** 80 pz. - volume m<sup>3</sup> 0,08 - Peso kg. 4

**Articolo dotato di codice a barre**



**art. 2128-3M**

[CE EN 143.2000 - A1]

Filtro per polveri, vapori organici e gas acidi in concentrazioni < TLV Classe P2

**CPN:** 2128

**Packing:** 20 pz. per conf.

**Imballo minimo per ordine:** 40 pz.

**Scatola:** 80 pz. - volume m<sup>3</sup> 0,08 - Peso kg. 4

**Articolo dotato di codice a barre**



**art. 2138-3M**

[CE EN 143.2000 - A1]

Filtro per polveri, vapori organici e gas acidi in concentrazioni < TLV Classe P3

**CPN:** 2138

**Packing:** 40 pz. per conf.

**Imballo minimo per ordine:** 80 pz.

**Scatola:** 80 pz. - volume m<sup>3</sup> 0,08 - Peso kg. 4

**Articolo dotato di codice a barre**



## Filtri per polveri, fumi e nebbie - FILTRI SERIE 5000

Per semimaschere e pieni facciali serie 6000/7000 a norma EN 143:2000 - A1 - Marcatura CE



### art. 5911

[CE EN 143.2000 - A1 2006]

Filtro per polveri Classe P1  
**CPN:** 5911  
**Packing:** 10 pz. per conf.  
**Imballo minimo per ordine:** 30 pz.  
**Scatola:** 120 pz. - volume m<sup>3</sup> 0,05 - Peso kg. 4  
**Articolo dotato di codice a barre**



## Filtri per polveri, fumi e nebbie - FILTRI SERIE 5000

Per semimaschere e pieni facciali serie 6000/7000 a norma EN 143:2000 - A1 - Marcatura CE

### art. 5925

[CE EN 143.2000 - A1]

Filtro per polveri Classe P2  
**CPN:** 5925  
**Packing:** 10 pz. per conf.  
**Imballo minimo per ordine:** 20 pz.  
**Scatola:** 80 pz. - volume m<sup>3</sup> 0,05 - Peso kg. 4  
**Articolo dotato di codice a barre**



### art. 5935-3M

[CE EN 143.2000 - A1]

Filtro per polveri Classe P3  
**CPN:** 5935  
**Packing:** 10 pz. per conf.  
**Imballo minimo per ordine:** 20 pz.  
**Scatola:** 80 pz. - volume m<sup>3</sup> 0,05 - Peso kg. 4  
**Articolo dotato di codice a barre**

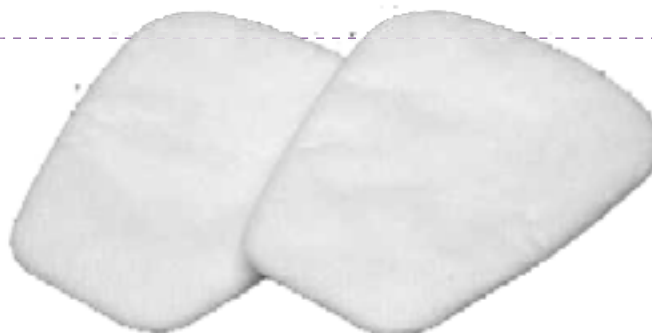

### art. 6035-3M

[CE EN 143.2000 - A1]

Filtro per polveri Classe P3 con protezione in policarbonato  
**CPN:** 6035  
**Packing:** 40 pz. per conf.  
**Imballo minimo per ordine:** 80 pz.  
**Scatola:** 80 pz. - volume m<sup>3</sup> 0,05 - Peso kg. 4  
**Articolo dotato di codice a barre**



### art. 6038

[CE EN 143.2000 - A1]

Filtro per polveri Classe P3 con carboni attivi e protezione in policarbonato  
**CPN:** 6038  
**Packing:** 40 pz. per conf.  
**Imballo minimo per ordine:** 80 pz.  
**Scatola:** 80 pz. - volume m<sup>3</sup> 0,05 - Peso kg. 4  
**Articolo dotato di codice a barre**



**Filtri per gas e vapori - FILTRI SERIE 6000 ad innesto diretto**

Per semimaschere e pieni facciali serie 6000/7000 a norma EN 141/EN 14387:2004 - Marcatura CE



**art. 6051-3M**

[CE EN 141:2000 + 1 14387:2004]

Filtro per gas e vapori organici - Classe A1

**CPN:** 6051

**Packing:** 8 pz. per conf.

**Imballo minimo per ordine:** 16 pz.

**Scatola:** 64 pz. - volume m<sup>3</sup> 0,08 - Peso kg. 6

**Articolo dotato di codice a barre**



**art. 6054-3M**

[CE EN 141/EN 14387:2004]

Filtro per ammoniaca/metilammina - Classe K1

**CPN:** 6054

**Packing:** 32 pz. per conf.

**Imballo minimo per ordine:** 64 pz.

**Scatola:** 64 pz. - volume m<sup>3</sup> 0,08 - Peso kg. 6

**Articolo dotato di codice a barre**



**art. 6055**

[CE EN 141/EN 14387:2004]

Filtro per gas e vapori organici - Classe A2

**CPN:** 6055

**Packing:** 8 pz. per conf.

**Imballo minimo per ordine:** 16 pz.

**Scatola:** 64 pz. - volume m<sup>3</sup> 0,08 - Peso kg. 6

**Articolo dotato di codice a barre**



**art. 6057-3M**

[CE EN 141/EN 14387:2004]

Filtro per vapori organici, inorganici e gas acidi - Classe ABE1

**CPN:** 6057

**Packing:** 8 pz. per conf.

**Imballo minimo per ordine:** 16 pz.

**Scatola:** 64 pz. - volume m<sup>3</sup> 0,08 - Peso kg. 6

**Articolo dotato di codice a barre**



## Filtri per polveri, fumi e nebbie - FILTRI SERIE 5000

Per semimaschere e pieni facciali serie 6000/7000 a norma EN 143:2000 - A1 - Marcatura CE



### art. 6059-3M

[CE EN 141/EN 14387:2004]

Filtro per vapori organici, gas/vapori inorganici, gas acidi e ammoniaca/metilammina. classe ABEK1.

CPN: 6059

Packing: 8 pz. per conf.

Imballo minimo per ordine: 16 pz.

Scatola: 64 pz. - volume m<sup>3</sup> 0,08 - Peso kg. 6

Articolo dotato di codice a barre



## Filtri gas e vapori - FILTRI SERIE 6000 ad innesto diretto

Solo per pieni facciali serie 6000/7000

### art. 6099-3M

[CE EN 141]

### art. 6098-3M

[CE EN 371]



Filtro per vapori organici, gas/vapori inorganici, gas acidi e ammoniaca/metilammina + polveri.

Classe ABEK2P3 (a norma EN 141)

CPN: 6099

Packing: 2 pz. per conf.

Imballo minimo per ordine: 12 pz.

Scatola: 32 pz. - volume m<sup>3</sup> 0,08

Peso kg. 5

Articolo dotato di codice a barre



Filtro per vapori organici con punto di ebollizione inferiore a 65°C + polveri classe AX P3 (a norma EN 371)

CPN: 6098

Packing: 2 pz. per conf.

Imballo minimo per ordine: 32 pz.

Scatola: 32 pz. - volume m<sup>3</sup> 0,08

Peso kg. 5

Articolo dotato di codice a barre



## Accessori per semimaschere e pieni facciali

Serie 6000/7000 per utilizzo di tutta la gamma filtri

### art. 501



Ghiera da utilizzare per combinare i filtri Serie 5000 con i filtri Serie 6000

CPN: 501

Packing: 20 pz. per conf.

Imballo minimo per ordine: 80 pz.

Scatola: 20 pz. - volume m<sup>3</sup> 0,03 - Peso kg. 1

Articolo dotato di codice a barre

### art. 502



Adattatore da utilizzare per montare filtri Serie 2000 su filtri Serie 6000.

CPN: 502

Packing: 32 pz. per conf.

Imballo minimo per ordine: 64 pz.

Scatola: 64 pz. - volume m<sup>3</sup> 0,08 - Peso kg. 5

Articolo dotato di codice a barre

### art. 603



Piattaforma da utilizzare per montare i filtri serie 5000 sulle semimaschere e sui pieni facciali

CPN: 603

Packing: 16 pz. per conf.

Imballo minimo per ordine: 16 pz.

Scatola: 16 pz. - volume m<sup>3</sup> 0,08 - Peso kg. 5

Articolo dotato di codice a barre



**Inserti Auricolari monouso**

**art. 1100 EA**



Inserti auricolari monouso Ear Classic SNR=28 dB  
**CPN:** PP-01-002  
**Applicazione:** industria  
**Imballo minimo per ordine:** 250 coppie  
**Packing:** 250 coppie per conf.  
**Scatola:** 1000 coppie - volume m<sup>3</sup> 0,08 - Peso kg. 8  
**Articolo dotato di codice a barre**



**art. 1100**

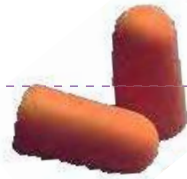

Inserti auricolari monouso SNR=37 dB  
**CPN:** 1100  
**Applicazione:** Industria, officina, agricoltura  
**Packing:** 200 coppie per conf.  
**Imballo minimo per ordine:** 1000 coppie  
**Scatola:** 1000 coppie - volume m<sup>3</sup> 0,10 - Peso kg. 9  
**Articolo dotato di codice a barre**



**art. 1120-3M**

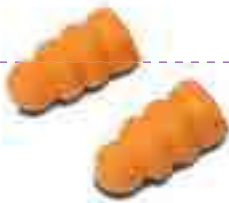

Inserti auricolari monouso SNR=34 dB  
**CPN:** 1120 **Applicazione:** industria  
**Imballo minimo per ordine:** 200 coppie  
**Packing:** 200 coppie per conf.  
**Scatola:** 1000 coppie - volume m<sup>3</sup> 0,08 - Peso kg. 8  
**Articolo dotato di codice a barre**



**art. 1110-3M**



Inserti auricolari monouso con cordicella SNR=37 dB  
**CPN:** 1110  
**Applicazione:** Industria, officina, agricoltura  
**Packing:** 100 coppie per conf.  
**Imballo minimo per ordine:** 500 coppie  
**Scatola:** 500 coppie - volume m<sup>3</sup> 0,08 - Peso kg. 7  
**Articolo dotato di codice a barre**



**Inserti Auricolari con archetto**

**art. 1310-3M**

[CE EN 352.2]



Inserti auricolari con archetto  
 SNR=25 dB  
**CPN:** 1310  
**Applicazione:** visitatori  
**Packing:** 10 pz. per conf.  
**Imballo minimo per ordine:** 10 pz.  
**Scatola:** 50 pz. - volume m<sup>3</sup> 0,08 - Peso kg. 4  
**Articolo dotato di codice a barre**



**art. 1311-3M**



Tamponi ricambio per archetti  
**CPN:** 1311  
**Applicazione:** visitatori  
**Packing:** 20 coppie per conf.  
**Imballo minimo per ordine:** 100 coppie  
**Scatola:** 100 coppie - volume m<sup>3</sup> 0,08 - Peso kg. 4  
**Articolo dotato di codice a barre**



**art. 1310P**



Inserti auricolari con archetto SNR=23 dB  
**CPN:** EC-01-000  
**Applicazione:** visitatori  
**Packing:** 10 pezzi per conf.  
**Imballo minimo per ordine:** 50 pezzi  
**Scatola:** 50 pezzi - volume m<sup>3</sup> 0,06 - Peso kg. 4  
**Articolo dotato di codice a barre**



**art. 1311P**



Tamponi ricambio per archetti  
**CPN:** ES-01-300  
**Applicazione:** visitatori  
**Packing:** 10 coppie per conf.  
**Imballo minimo per ordine:** 100 coppie  
**Scatola:** 500 coppie - volume m<sup>3</sup> 0,20 - Peso kg. 9  
**Articolo dotato di codice a barre**







## Cuffie Antirumore

a norma EN 352 - Marcatura CE

### art. 1430



4 001895 844751

Cuffie auricolari  
SNR=24 dB

**CPN:** H4A 300

**Applicazione:** industria, edilizia, agricoltura

**Packing:** 1 pz. per conf.

**Imballo minimo per ordine:** 1 pz

**Scatola:** 20 pezzi - volume m<sup>3</sup> 0,10 - Peso kg. 5

**Articolo dotato di codice a barre**



EN 352



### art. 1435P

EN 352



8 011818 148589

Cuffia auricolare "PELTOR" OPTIME I  
SNR=27dB

**CPN:** H510A-401-GU

**Applicazione:** industria, edilizia

**Packing:** 1 pz. per conf.

**Imballo minimo per ordine:** 1 pz.

**Scatola:** 20 pz. - volume m<sup>3</sup> 0,10 - Peso kg. 5

**Articolo dotato di codice a barre**



### art. 1440P

EN 352



8 011818 148251

Cuffia auricolare  
OPTIME II SNR=31dB

**CPN:** H520A-407-GQ

**Applicazione:** industria, edilizia

**Packing:** 1 pz per conf.

**Imballo minimo per ordine:** 1 pz.

**Scatola:** 20 pezzi - volume m<sup>3</sup> 0,10 - Peso kg. 5

**Articolo dotato di codice a barre**



### art. 1445

EN 352



3 134375 411882

Cuffie auricolari ad alta attenuazione OPTIME III  
SNR=32 dB

**CPN:** H540A-411-SV

**Applicazione:** industria, edilizia, agricoltura

**Packing:** 1 pz. per conf.

**Imballo minimo per ordine:** 1 pz.

**Scatola:** 6 pezzi - volume m<sup>3</sup> 0,08 - Peso kg. 1,5

**Articolo dotato di codice a barre**



# INDICE

## NORME SISTEMI ANTICADUTA

..... pag. 338

## ARTICOLI ANTICADUTA

Imbragature..... pag. 342

Cordini - Assorbitori..... pag. 344

Accessori..... pag. 346

Moschettoni..... pag. 348

Cavalletto - Argano..... pag. 349

## SOLUZIONI ANTICADUTA

per coperture..... pag. 350

per ponteggi..... pag. 352

per lavorazioni in altezza con cestello..... pag. 354

per lavorazioni in altezza su alberi..... pag. 355

## FASCE DI SOLLEVAMENTO - CRICCHETTI

Normativa..... pag. 356

Tiranti in poliestere..... pag. 356

Funi tonde..... pag. 357

Dispositivi di ancoraggio..... pag. 357



# SEBA



# SISTEMA DE ANTICADUTA



# SISTEMA DE ANTICADUTA



SEBA



# NORME SISTEMI ANTICADUTA

## DISPOSITIVI DI PROTEZIONE INDIVIDUALE CONTRO LE CADUTE DALL'ALTO

- EN 341** Dispositivi di discesa
- EN 353-1** Dispositivi anticaduta di tipo guidato su una linea di ancoraggio rigida
- EN 353-2** Dispositivi anticaduta di tipo guidato su una linea di ancoraggio flessibile
- EN 354** Cordini
- EN 355** Assorbitori di energia
- EN 360** Dispositivi anticaduta di tipo retrattile
- EN 361** Imbragatura per il corpo
- EN 362** Connettori
- EN 363** Sistemi di arresto caduta
- EN 364** Metodi di prova
- EN 365** Requisiti generali per le istruzioni per l'uso e la marcatura
- EN 798** Dispositivi di ancoraggio - Requisiti e prove

## DISPOSITIVI INDIVIDUALI PER IL POSIZIONAMENTO SUL LAVORO

- EN 358** Cinture e cordini per il posizionamento sul lavoro
- EN 813** Cinture con cosciali

### LAVORO IN QUOTA

“Attività lavorativa che espone il lavoratore al rischio di caduta da una quota posta ad un'altezza superiore a 2 m rispetto ad un piano stabile”.

### DPI CONTRO LE CADUTE DALL'ALTO

Dispositivo atto ad assicurare una persona ad un punto di ancoraggio in modo tale da prevenire completamente o di arrestare in condizioni di sicurezza la caduta dall'alto.

### SISTEMA DI ARRESTO CADUTA

Dispositivo di protezione individuale contro le cadute dall'alto comprendente un'imbragatura per il corpo ed un sottosistema di collegamento destinati ad arrestare le cadute.

### SISTEMA DI POSIZIONAMENTO SUL LAVORO

Un sistema di posizionamento sul lavoro è composto da componenti collegati fra di loro che costituiscono un'attrezzatura completa pronta per essere usata per il posizionamento sul lavoro. I sistemi di posizionamento sul lavoro sono destinati a sostenere addetti che devono operare in altezza con sostegno su pali o altre strutture consentendo loro di poter lavorare con entrambe le mani libere. Questi sistemi non sono destinati all'arresto delle cadute.

## Esempi:

UTILIZZO	1	2	3	4	5	6	7	8	9	10	EN358 Caduta libera inferiore a 10,5m	EN363 Rischi di una caduta vera e propria
Guardafili/montapali con protezione anticaduta adeguata - p.e. scala ingabbiata	*	/	/	/	/	*	/	/	/	/	si	/
Guardafili/montapali senza protezione anticaduta adeguata - con un punto di ancoraggio con una resistenza di 10 Kg	/	/	/	*	*	*	/	*	/	/	si	si
Lavori su ponteggi e impalcature con spostamenti in orizzontale	/	*	*	/	/	/	*	/	*	/	/	si
Lavori su ponteggi e impalcature con una protezione durante la salita e discesa con la possibilità di autosalvataggio.	/	/	*	/	*	*	/	/	*	/	(si)	si
Lavori su finestre aperte con un punto di ancoraggio con una resistenza di 10 kg.	/	*	/	/	/	/	/	*	/	/	/	si
Lavoro su facciata di fabbricati con un punto di ancoraggio per il dispositivo scorrevole apribile dotato di autosalvataggio	/	/	/	/	*	*	/	/	*	/	si	si
Montaggi di impalcature con punto di ancoraggio in alto con resistenza 10 kg	/	/	/	*	/	*	/	*	/	/	si	si
Lavori sotto una linea di ancoraggio orizzontale	/	*	*	/	/	/	*	/	*	/	/	si
Lavori in pozzi, cisterne e silos	/	/	/	/	*	*	/	/	/	*	si	si
Gabbie su gru, camion, ecc, per protezione effetto "catapulta" anti-lancio	*	/	/	/	/	*	/	/	/	/	si	/
Lavori sui tetti con ancoraggio sternale	/	/	*	/	*	*	/	/	*	/	(si)	si
Salite di una torre senza fune	/	*	/	/	/	/	*	/	/	/	/	si
Lavori su autobotte con paramano e pedana	/	/	/	*	/	*	*	/	*	/	si	si

## Legenda:

- 1 art. 69G ECO
- 2 art. 69H ECO
- 3 art. 69L ECO
- 4 art. 69M ECO
- 5 art. 69C ECO
- 6 art. 69F / 69F ECO
- 7 art. 69N / 69D
- 8 art. 69E10 / 69E20
- 9 art. 69A10/20/30
- 10 art. 69R / 69S20

**Si effettuano corsi sulle verifiche annuali su DPI Anticaduta ( Cinture, Imbragature, Retrattili, ecc.)**



**SICUREZZA**  
**SAFETY**

## art. 69TOP

[CE EN 358-EN361-EN813]



Collegamento a cosciale estensibile



8 011818 120691

Imbragatura anticaduta con 3 punti di ancoraggio dorsale, sternale e frontale. Da completare con il cordino di posizionamento art. 69F-ECO e moschettone a scelta.

**Applicazione:** Lavori di manutenzione ed ispezione in altezza dove è necessario lavorare con due mani libere in equilibrio. Lavori su pali, tralicci, gru, scale e coperture.

**Packing:** 1 pezzo

**Imballo minimo per ordine:** 1 pz.

**Scatola:** 15 pz. - volume m<sup>3</sup> 0,10 Peso kg. 12

**Articolo dotato di codice a barre e confezione appendibile.**



UNICA  
REGOLABILE

## art. 69C-ECO

[CE EN 358-EN361]



8 011818 106336

Imbragatura anticaduta con punto di ancoraggio dorsale e sternale. Completare con cordino di posizionamento nostro art. 69F ECO e moschettone a scelta.

**Applicazione:** Lavori di manutenzione ed ispezione in altezza dove è necessario lavorare con due mani libere in equilibrio. Lavori su pali, tralicci, gru, scale e coperture.

**Packing:** 1 pezzo

**Imballo minimo per ordine:** 1 pz.

**Scatola:** 25 pz. - volume m<sup>3</sup> 0,10 - Peso kg. 30

**Articolo dotato di codice a barre e confezione appendibile.**



UNICA  
REGOLABILE



## art. 69L-ECO



8 011818 120677



Imbragatura anticaduta con punto di ancoraggio dorsale e sternale. Da completare con cordino art.69F ECO e moschettone 69U.

**Applicazione:** Lavori di manutenzione ed ispezione in altezza dove è necessario lavorare con due mani libere in equilibrio. Lavori su pali, tralicci, gru, scale e coperture.

**Packing:** 1 pezzo

**Imballo minimo per ordine:** 1 pz.

**Scatola:** 50 pz. - volume m<sup>3</sup> 0,15 - Peso kg. 35

**Articolo dotato di codice a barre e confezione appendibile.**



[ CE EN361 ]

UNICA  
REGOLABILE

## art. 69G-ECO



8 011818 105063



Cintura di mantenimento con protezione per la schiena termoformata. 2 Punti di ancoraggio laterali di posizionamento. Da abbinare con cordino di posizionamento art.69F ECO.

**Applicazione:** La cintura di posizionamento è un dispositivo di trattenuta che, in caso di caduta, trattiene l'operatore impedendone lo scivolamento e/o il rotolamento. Non deve assolutamente essere utilizzato per arrestare una caduta dinamica.

**Packing:** 1 pezzo

**Imballo minimo per ordine:** 1 pezzo

**Scatola:** 50 pz. - volume m<sup>3</sup> 0,10 - Peso kg. 20

**Articolo dotato di codice a barre e confezione appendibile.**



[ CE EN358 ]

UNICA  
REGOLABILE

art. 69F-ECO

[ CE EN358 ]



8 011818 106381

Cordino di posizionamento in poliammide compreso di gancio

**Packing:** 1 pezzo

**Imballo minimo per ordine:** 1 pz.

**Scatola:** 70 pz. - volume m<sup>3</sup> 0,15 - Peso kg. 15

**Articolo dotato di codice a barre e confezione appendibile.**

art. 69N

[ CE EN355 ]



8 011818 107579

Assorbitore di energia composto da fune in nylon.

Diametro 12 mm con due capi + assorbitore di energia.

Lunghezza mt. 1,5.

**Packing:** 1 pezzo

**Imballo minimo per ordine:** 1 pz.

**Scatola:** 40 pz. - volume m<sup>3</sup> 0,10 - Peso kg. 25

**Articolo dotato di codice a barre e confezione appendibile.**

art. 69N2

[ CE EN355 ]

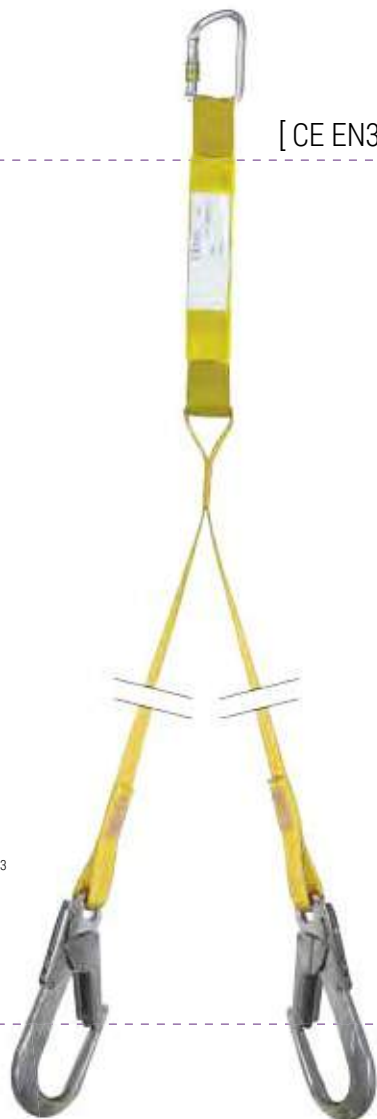

8 011818 135107

Assorbitore energia + 2 nastri da mt. 1,3 cad.

**Packing:** 1 pezzo

**Imballo minimo per ordine:** 1 pz.

**Scatola:** 15 pz. - volume m<sup>3</sup>

0,03 - Peso kg. 2

**Articolo dotato di codice a barre e confezione appendibile.**

art. 69D

[ CE EN355 ]



8 011818 120707

Dissipatore di energia, realizzato in materiale tessile, protetto da una custodia. Forza massima sviluppata durante la fase d'ammortamento della caduta: <600DAN da usare per una sola caduta. Lunghezza complessiva del sistema mt 2

**Packing:** 1 pezzo

**Imballo minimo per ordine:** 1 pz.

**Scatola:** 35 pz. - volume m<sup>3</sup> 0,10 - Peso kg. 10

**Articolo dotato di codice a barre e confezione appendibile.**

## art. 69A10

[ CE EN353 ]



10 mt

Dispositivo anticaduta brevettato, ideato per rendere sicuro il lavoro di operatori in luoghi sopraelevati, impedendone la caduta mediante bloccaggio del dispositivo sulla corda dovuto ad effetto cuneo di cursori scorrevoli su guide inclinate. Corredata da fune. Lunghezza mt 10. La fune deve essere ancorata ad un punto fisso posto al di sopra della posizione di lavoro. Il dispositivo deve essere completato inoltre da una cintura con bretelle

**Packing:** 1 pezzo

**Imballo minimo per ordine:** 1 pz.

**Scatola:** 25 pz. - volume m<sup>3</sup> 0,15 - Peso kg. 15

**Articolo dotato di codice a barre e confezione appendibile.**

## art. 69A20

[ CE EN353 ]



20 mt

Dispositivo anticaduta brevettato, ideato per rendere sicuro il lavoro di operatori in luoghi sopraelevati, impedendone la caduta mediante bloccaggio del dispositivo sulla corda dovuto ad effetto cuneo di cursori scorrevoli su guide inclinate. Corredata da fune. Lunghezza mt 20. La fune deve essere ancorata ad un punto fisso posto al di sopra della posizione di lavoro. Il dispositivo deve essere completato inoltre da una cintura con bretelle

**Packing:** 1 pezzo

**Imballo minimo per ordine:** 1 pz.

**Scatola:** 15 pz. - volume m<sup>3</sup> 0,15 - Peso kg. 15

**Articolo dotato di codice a barre e confezione appendibile.**

## art. 69A30

[ CE EN353 ]



30 mt

Dispositivo anticaduta brevettato, ideato per rendere sicuro il lavoro di operatori in luoghi sopraelevati, impedendone la caduta mediante bloccaggio del dispositivo sulla corda dovuto ad effetto cuneo di cursori scorrevoli su guide inclinate. Corredata da fune. Lunghezza mt 30. La fune deve essere ancorata ad un punto fisso posto al di sopra della posizione di lavoro. Il dispositivo deve essere completato inoltre da una cintura con bretelle

**Packing:** 1 pezzo

**Imballo minimo per ordine:** 1 pz.

**Scatola:** 8 pz. - volume m<sup>3</sup> 0,15 - Peso kg. 15

**Articolo dotato di codice a barre e confezione appendibile.**

## art. 69QA

[ CE EN360 ]



Arrotolatore in nastro retrattile dotato di dissipatore di energia e due moschettoni 69U. Libertà di movimento 2,20 mt circa

**Packing:** 1 pezzo

**Imballo minimo per ordine:** 1 pz.

**Scatola:** 40 pz. - volume m<sup>3</sup> 0,15 - Peso kg. 18

**Articolo dotato di codice a barre e confezione appendibile.**



## art. 69MAX10



8 011818 124422

Dispositivo anticaduta in ABS con filo di acciaio m10, avvolgimento automatico. Utilizzo in verticale ed orizzontale.

**Packing:** 1 pezzo

**Imballo minimo per ordine:** 1 pz.

**Scatola:** 1 pz. - volume m<sup>3</sup> 0,08 - Peso kg. 5,00

**Articolo dotato di codice a barre**



[ CE EN360 ]



10 mt

## art. 69MAX20



8 011818 124439

Dispositivo anticaduta in ABS con filo di acciaio m20, avvolgimento automatico. Utilizzo in verticale ed orizzontale.

**Packing:** 1 pezzo

**Imballo minimo per ordine:** 1 pz.

**Scatola:** 1 pz. - volume m<sup>3</sup> 0,10 - Peso kg. 8,3

**Articolo dotato di codice a barre**



[ CE EN360 ]



20 mt

## art. 69E10

STOP MAX Dispositivo anticaduta costituito da una fune d'acciaio, e un dispositivo di bloccaggio automatico, protetto da un involucro sempre in acciaio. Non richiede manutenzioni particolari. Da m10 di lunghezza. Moschettone terminale a doppi comandi girevole compreso nel prezzo. Moschettone superiore a richiesta, non compreso nel prezzo. Utilizzo esclusivamente in verticale.

**Packing:** 1 pezzo

**Imballo minimo per ordine:** 1 pz.

**Scatola:** 1 pz. - volume m<sup>3</sup> 0,08 - Peso kg. 5,5

**Articolo dotato di codice a barre**



8 011818 135848



[ CE EN360 ]



10 mt

## art. 69E20

STOP MAX Dispositivo anticaduta costituito da una fune d'acciaio, e un dispositivo di bloccaggio automatico, protetto da un involucro sempre in acciaio. Non richiede manutenzioni particolari. Da m 20 di lunghezza. Moschettone terminale a doppi comandi girevole compreso nel prezzo. Moschettone superiore a richiesta, non compreso nel prezzo. Utilizzo esclusivamente in verticale.

**Packing:** 1 pezzo

**Imballo minimo per ordine:** 1 pz.

**Scatola:** 1 pz. - volume m<sup>3</sup> 0,10 - Peso kg. 7,5

**Articolo dotato di codice a barre**



8 011818 133400

[ CE EN360 ]



20 mt

## art. 69E

[ CE EN354 ]



8 011818 120660

Cordino di collegamento. Lunghezza max cm 150.

**Packing:** 1 pezzo**Imballo minimo per ordine:** 10 pz.**Scatola:** 150 pz. - volume m<sup>3</sup> 0,10 - Peso kg. 14**Articolo dotato di codice a barre e confezione appendibile.**

## art. 69Z

[ CE EN795 ]



8 011818 131437

Fettuccia di ancoraggio orizzontale e/o verticale

**Packing:** 1 pezzo**Imballo minimo per ordine:** 1 pz.**Scatola:** 10 pz. - volume m<sup>3</sup> 0,05 Peso kg. 1**Articolo dotato di codice a barre e confezione appendibile.**

## art. 70BL



Zainetto porta DPI, H.43 P.19

Larghezza 30

**Packing:** 1 pezzo**Imballo minimo per ordine:** 20 pz.**Scatola:** 20 pz. - volume m<sup>3</sup> 0,15 - Peso kg. 10**Articolo dotato di codice a barre**

8 011818 113044

## art. 427C

[ CE EN397 ]



8 011818 130157

Elmetto giallo con visiera FLAT con sottogola inserito.

**Packing:** 1 pezzo**Imballo minimo per ordine:** 1 pz.**Scatola:** 40 pz. - volume m<sup>3</sup> 0,15 Peso kg. 10**Articolo dotato di codice a barre**

art. 69AP

[CE EN362]



CE



8 011818 131451

Pinza in acciaio indispensabile nell'aggancio su impalcature tubolari, inserendola alla fune dell'art. 69A 10/20/30. Dimensioni: 33,5x10 cm  
**Packing:** 1 pezzo  
**Imballo minimo per ordine:** 10 pz.  
**Scatola:** 40 pz. - volume m<sup>3</sup> 0,10 - Peso kg. 14  
**Articolo dotato di codice a barre**

art. 69UA

[CE EN362]



CE



8 011818 135886

Moschettone a doppia leva in lega leggera, apertura mm 60. Dimensioni: 22x10,5 cm  
**Packing:** 1 pezzo  
**Imballo minimo per ordine:** 1 pz.  
**Scatola:** 30 pz. - volume m<sup>3</sup> 0,10 - Peso kg. 10  
**Articolo dotato di codice a barre**

art. 69U

[CE EN362]



CE



8 011818 107616

Moschettone in lega leggera. Dimensioni: 10x5 cm  
**Packing:** 1 pezzo  
**Imballo minimo per ordine:** 10 pz.  
**Scatola:** 10 pz. - volume m<sup>3</sup> 0,08 - Peso kg. 1  
**Articolo dotato di codice a barre**

art. 69V

[CE EN362]

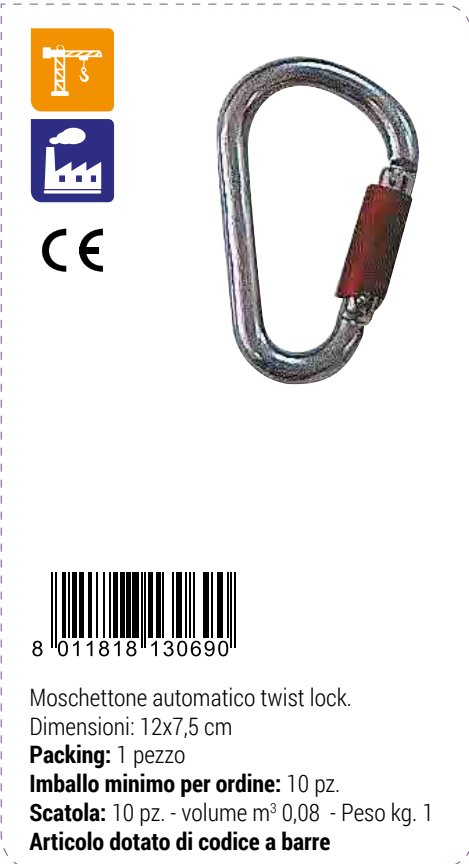

CE



8 011818 130690

Moschettone automatico twist lock. Dimensioni: 12x7,5 cm  
**Packing:** 1 pezzo  
**Imballo minimo per ordine:** 10 pz.  
**Scatola:** 10 pz. - volume m<sup>3</sup> 0,08 - Peso kg. 1  
**Articolo dotato di codice a barre**

art. 69T

[CE EN362]



CE



8 011818 107586

Moschettone automatico. Dimensioni: 12x7 cm  
**Packing:** 1 pezzo  
**Imballo minimo per ordine:** 10 pz.  
**Scatola:** 10 pz. - volume m<sup>3</sup> 0,03 - Peso kg. 1  
**Articolo dotato di codice a barre**

art. 69B

[CE EN362]

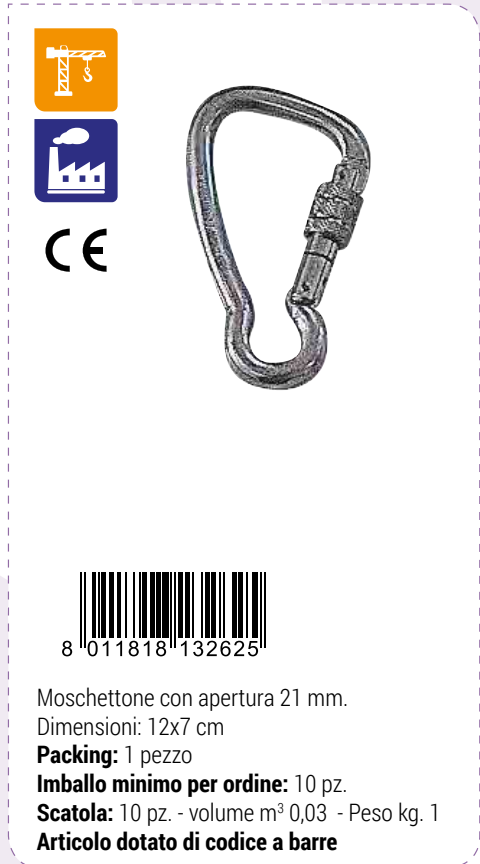

CE



8 011818 132625

Moschettone con apertura 21 mm. Dimensioni: 12x7 cm  
**Packing:** 1 pezzo  
**Imballo minimo per ordine:** 10 pz.  
**Scatola:** 10 pz. - volume m<sup>3</sup> 0,03 - Peso kg. 1  
**Articolo dotato di codice a barre**

## art. 69R

[EN795:1996/B+A1:2000]



8 011818 147643



Cavalletto a tre piedi in alluminio. Combinare con dispositivo di recupero ( argano ) art. 69S-20 marcato CE conforme EN1496:2006 per il salvataggio e un sottosistema anticaduta adeguato per la discesa in pozzi, silos ecc.

**Packing:** 1 pezzo

**Imballo minimo per ordine:** 1 pz.

**Scatola:** 1 pz. - volume m<sup>3</sup> 0,20 - Peso kg. 17

**Articolo dotato di codice a barre**



## art. 69S20

[EN71496:2006 CLASSE B]



8 011818 147650



Argano da 20 m con cavo in acciaio, da abbinare al trepiedi art. 69R

**Packing:** 1 pezzo

**Imballo minimo per ordine:** 1 pz.

**Scatola:** 1 pz. - volume m<sup>3</sup> 0,05 - Peso kg. 14

**Articolo dotato di codice a barre**



# SEBA

# Soluzione Anticaduta

INDICATO PER LAVORAZIONI DA SVOLGERSI SU COPERTURE

## Ipotesi di composizione 1

Soluzione A

LINEA VITA



Soluz. B



ART.69-AP - 1 pz.  
PINZA DI ANCORAGGIO

**Utilizzo:** collegare al moschettone 69U l'art. 69A10/20/30 e agganciarsi possibilmente alla linea vita (Soluzione A), nel caso non esistesse, si può utilizzare l'art 69P barra per porta - fissaggio temporaneo ( Soluzione B ).

1



ART.69A/10/20/30 - 1 pz.  
DISPOSITIVO ANTICADUTA  
**Utilizzo:** Da utilizzare in base all'altezza, collegare l'asola dell'articolo 69 A 10/20/30 al moschettone e all'art. 69AP.

2



ART.69N - 1 pz.  
DISSIPATORE  
**Utilizzo:** Collegare la parte arancio dell'art 69N all'art 69 A 10/20/30 nel dispositivo in acciaio mediante un moschettone.

3



ART.69C-ECO - 1 pz.  
IMBRACATURA

4

**Utilizzo:** collegare nella parte dorsale o sternale l'asola della corda dell'articolo 69N mediante moschettone.



7 ART.69U - 4 pz.  
MOSCHETTONI NECESSARI



8 ART.69P - 1 pz.  
BARRA PORTA  
**Utilizzo:** permette di utilizzare una porta come struttura di fissaggio, temporale.



9 ART.427C - 1 pz.  
ELMETTO  
**Utilizzo:** utilizzare sempre questo tipo di elmetto senza visiera con sottogola.



10 ART.70BL - 1 pz.  
ZAINO PER CONTENERE IL KIT

**IMPORTANTE:** tenere sempre la corda dell'articolo 69A 10/20/30 in verticale, per evitare il gioco a pendolo. Facendo scorrere il dispositivo anticaduta in acciaio sulla corda in base all'altezza desiderata l'operatore sarà in sicurezza 3P.



# Soluzione Anticaduta

INDICATO PER LAVORAZIONI DA SVOLGERSI SU COPERTURE

## Ipotesi di composizione 2

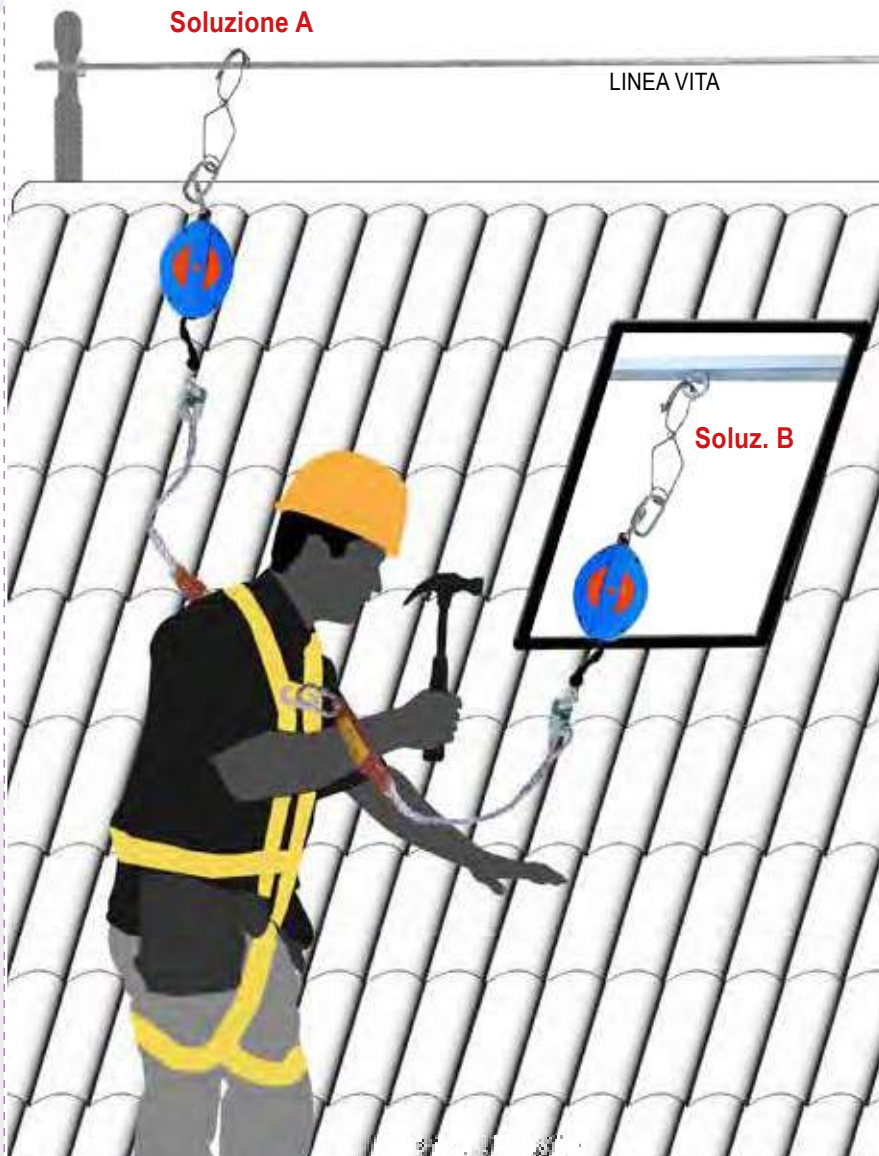

Soluzione A

LINEA VITA

Soluz. B

1



ART.69-AP - 1 pz.

PINZA DI ANCORAGGIO

**Utilizzo:** collegare al moschettone 69U l'art. 69MAX 10-20-30 e agganciarsi possibilmente alla linea vita (Soluzione A), nel caso non esistesse, si può utilizzare l'art 69P barra per porta - fissaggio temporaneo ( Soluzione B ).

2



ART.69MAX/10/20/30 - 1 pz.

DISPOSITIVO ANTICADUTA

**Utilizzo:** collegare il moschettone posto alla fine del cavo d'acciaio all'asola della corda dell'articolo 69N.

3



ART.69N - 1 pz.

DISSIPATORE

**Utilizzo:** Collegare la parte arancio mediante un moschettone art 69U all'imbracatura art. 69C ECO parte dorsale o sternale in base all'esigenze.

5



ART.69P - 1 pz.

BARRA PORTA

**Utilizzo:** permette di utilizzare una porta come struttura di fissaggio, temporale.

7

ART.427C - 1 pz.

ELMETTO

**Utilizzo:** utilizzare sempre questo tipo di elmetto senza visiera con sottogola.



6

ART.69U - 4 pz.

MOSCHETTONI NECESSARI



8

ART.70BL - 1 pz.

ZAINO PER CONTENERE IL KIT



4

ART.69C-ECO - 1 pz.

IMBRACATURA

**Utilizzo:** collegare nella parte dorsale o sternale l'asola della corda dell'articolo 69N mediante moschettone.



# Soluzione Anticaduta

INDICATO PER IL MONTAGGIO DEI PONTEGGI

## Ipotesi di composizione 1

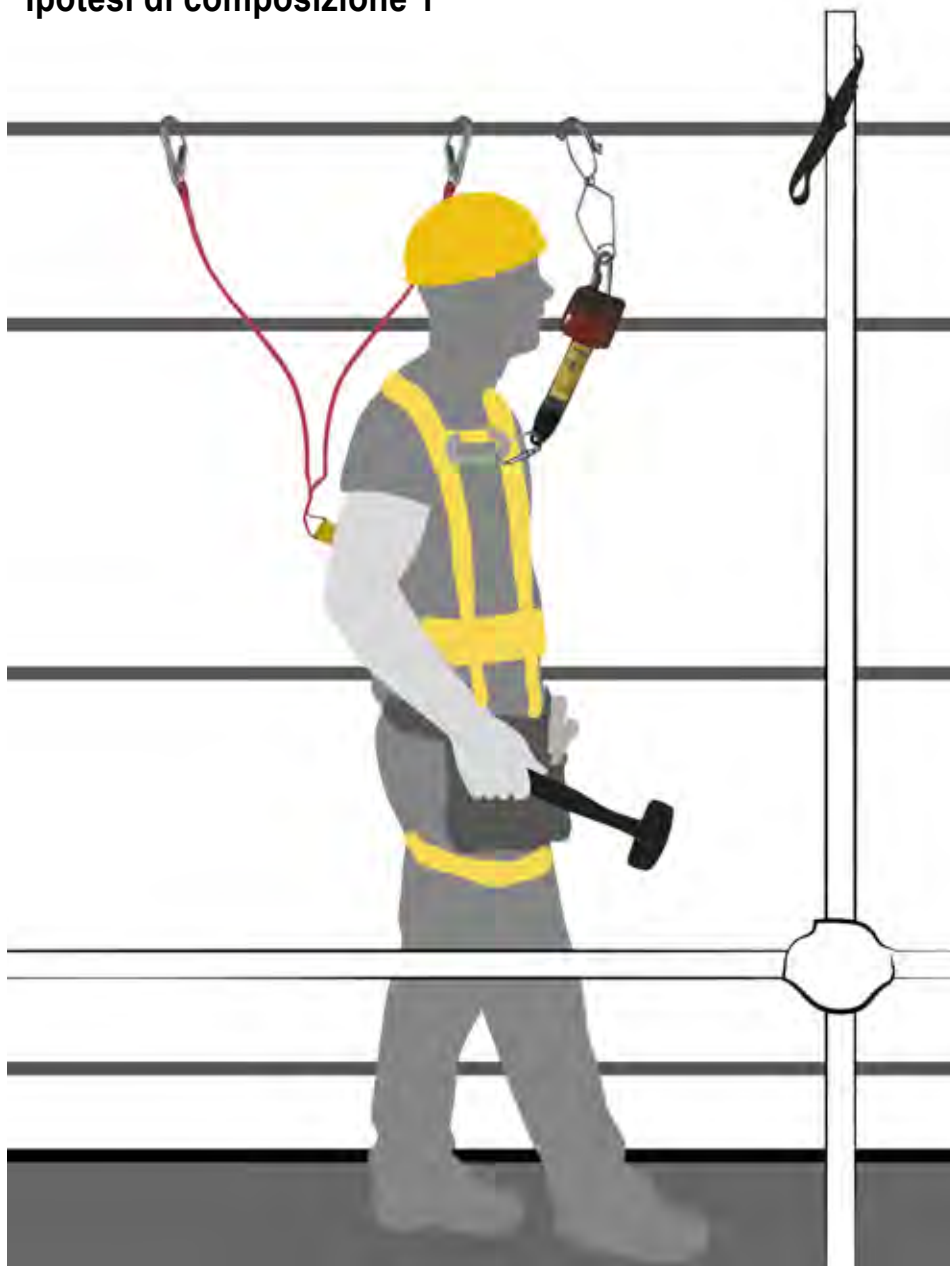

**1** ART.69-Z - 1 pz.  
FETTUCCIA DI AGGANCIO  
**Utilizzo:** da utilizzare in ancoraggio su tubi o altro in verticale.



**2** ART.69-AP - 1 pz.  
PINZA DI ANCORAGGIO  
**Utilizzo:** collegare con l'articolo 69QA parte rossa, e agganciarsi sopra l'operatore parte più alta.



**3** ART.69QA - 1 pz.  
ARROTOLATORE  
**Utilizzo:** collegare la parte terminale del dissipatore in tessuto con l'imbracatura art. 69C-ECO, nella parte dorsale o sternale dell'operatore in base all'esigenza.



**4** ART.69N2 - 1 pz.  
ASSORBITORE ENERGIA + 2 NASTRI DA MT. 1,3 CAD.  
**Utilizzo:** collegare il moschettone piccolo nella parte dorsale o sternale della cintura 69C-ECO in base alle esigenze, agganciare i due moschettoni grandi al tubo e in caso di spostamento dell'operatore sganciare sempre un moschettone per volta lasciando l'altro agganciato per mantenere l'operatore in massima sicurezza.



**6** ART.69U - 3 pz.  
MOSCHETTONI DI SCORTA



ART.427C - 1 pz.  
ELMETTO

**7** **Utilizzo:** utilizzare sempre questo tipo di elmetto senza visiera con sottogola.



**8** ART.70BL - 1 pz.  
ZAINO PER CONTENERE IL KIT



**5** ART.69C-ECO - 1 pz.  
IMBRACATURA

# Soluzione Anticaduta

INDICATO PER IL MONTAGGIO DEI PONTEGGI

## Ipotesi di composizione 2

1



**ART.69-Z** - 1 pz.  
FETTUCCIA DI AGGANCIO  
**Utilizzo:** da utilizzare in ancoraggio su tubi o altro in verticale.

2



**ART.69-AP** - 1 pz.  
PINZA DI ANCORAGGIO  
**Utilizzo:** collegarsi mediante moschettone 69U l'art. 69A10/20/30 in base all'altezza dell'operatore.

3



**ART.69A/10/20/30** - 1 pz.  
DISPOSITIVO ANTICADUTA  
**Utilizzo:** Nel dispositivo in acciaio collegare la parte rossa del dissipatore art 69N con un moschettone 69U.

4



**ART.69N** - 1 pz.  
DISSIPATORE  
**Utilizzo:** Collegare con un moschettone l'asola della corda dell'art. 69N all'imbracatura art. 69C ECO dalla parte dorsale o sternale in base alle esigenze.

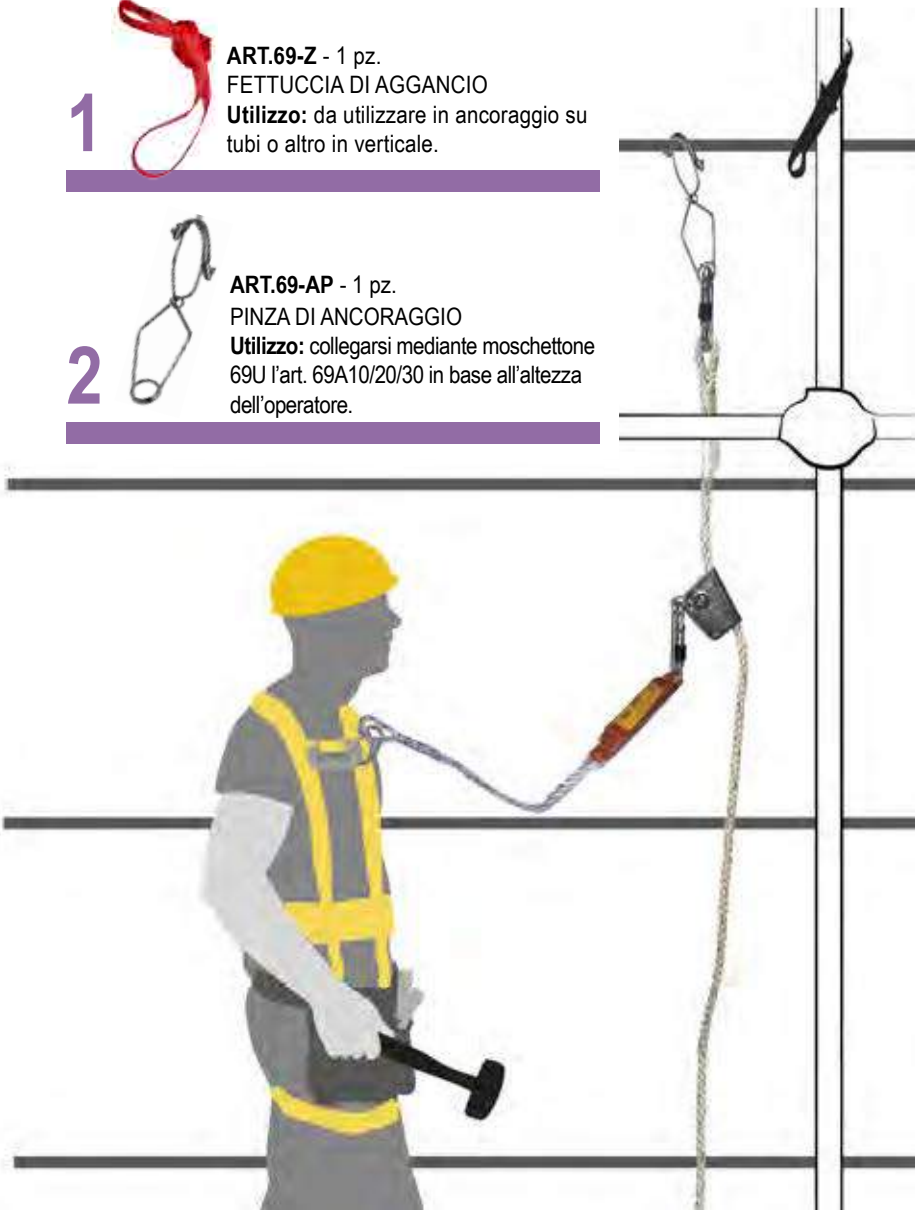

5

**ART.69C ECO** - 1 pz.  
IMBRACATURA  
**Utilizzo:** Collegare l'art.69N2 nella parte dorsale o sternale con il moschettone piccolo art. 69U.

6



**ART.69N2** - 1 pz.  
ASSORBITORE ENERGIA +  
2 NASTRI DA MT. 1,3 CAD.  
**Utilizzo:** agganciare i due moschettoni grandi al tubo e, in caso di spostamento dell'operatore, sganciare sempre un moschettone per volta per mantenere in sicurezza l'operatore.

7



**ART.69U** - 3 pz.  
MOSCHETTONI DI SCORTA

8



**ART.427C** - 1 pz.  
ELMETTO  
**Utilizzo:** utilizzare sempre questo tipo di elmetto senza visiera con sottogola.

9



**ART.70BL** - 1 pz.  
ZAINO PER CONTENERE IL KIT

## Soluzione Anticaduta

INDICATO PER OPERATORI CHE UTILIZZANO IL CESTELLO  
PER LAVORAZIONI IN ALTEZZA

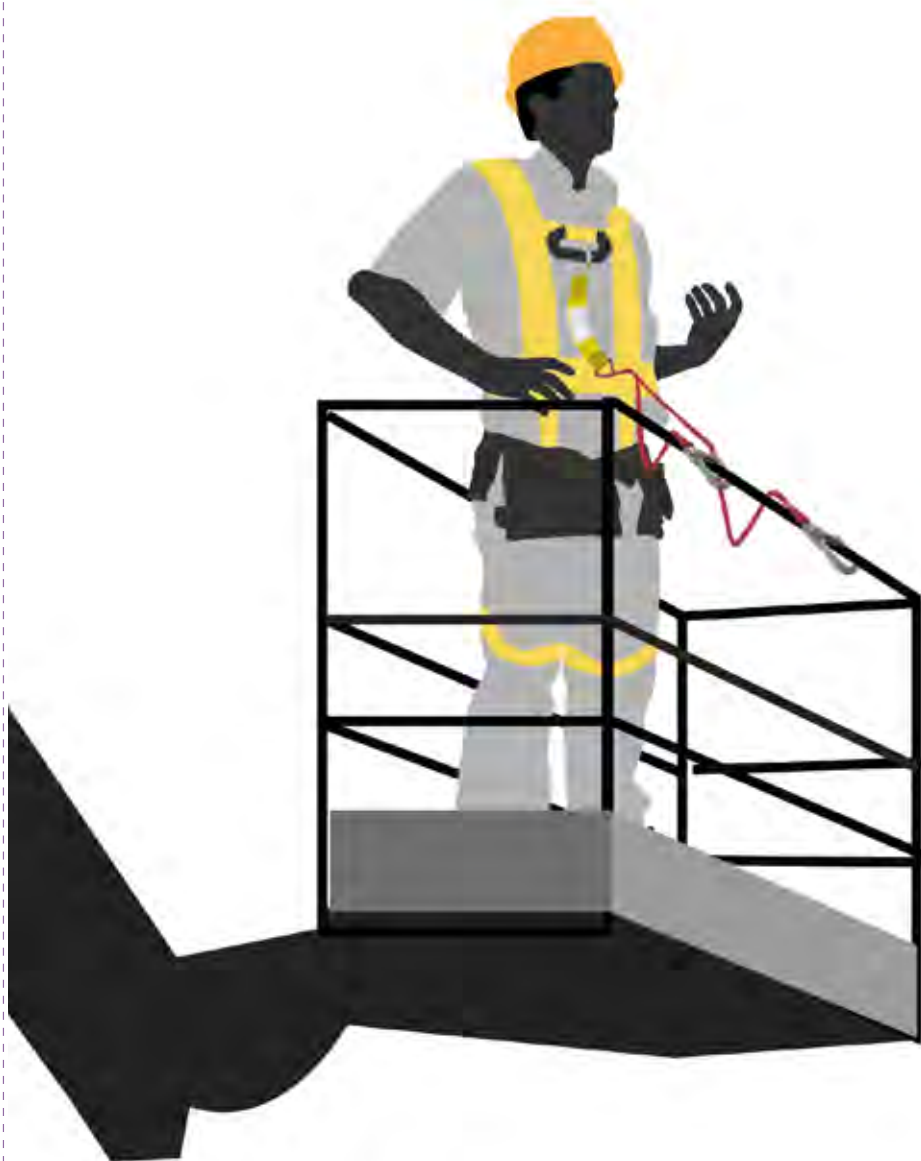

**1** ART.69C-ECO - 1 pz.  
IMBRACATURA

**Utilizzo:** indossare l'imbracatura collegando nella zona dorsale o sternale il moschettone piccolo dell'articolo 69N2.



ART.69N2 - 1 pz.  
ASSORBITORE ENERGIA +  
2 NASTRI DA MT. 1,3 CAD.

**Utilizzo:** collegare il moschettone piccolo nella parte dorsale o sternale della cintura 69C-ECO in base alle esigenze e agganciare al cestello i due moschettoni grandi.



ART.427C - 1 pz.  
ELMETTO

**3** **Utilizzo:** utilizzare sempre questo tipo di elmetto senza visiera con sottogola.



**4** ART.70BL - 1 pz.  
ZAINO PER CONTENERE IL KIT

## Soluzione Anticaduta

INDICATO PER LE LAVORAZIONI DI POTATURA DI ALBERI



1

**ART.69-Z** - 1 pz.  
FETTUCCIA DI AGGANCIAMENTO  
**Utilizzo:** Agganciare la fettuccia ad un grosso ramo nel punto più alto dell'operatore. Collegare con un moschettone art. 69U l'asola di corda dell'art. 69A/10/20/30



2

**ART.69A/10/20/30** - 1 pz.  
DISPOSITIVO ANTICADUTA  
**Utilizzo:** Collegare il dispositivo in acciaio con un moschettone art 69U l'asola di corda dell'articolo 69N



3

**ART.69C-ECO** - 1 pz.  
IMBRAGATURA  
**Utilizzo:** collegare l'articolo 69N terminale arancio con un moschettone, la parte dorsale o sternale dell'articolo 69C ECO



7

**ART.69U** - 3 pz.  
MOSCHETTONI DI SCORTA



8

**ART.427C** - 1 pz.  
ELMETTO  
**Utilizzo:** utilizzare sempre questo tipo di elmetto senza visiera, flat con sottogola.



9

**ART.70BL** - 1 pz.  
ZAINO PER CONTENERE IL KIT

## DISPOSITIVI DI SOLLEVAMENTO IN POLIESTERE TIRANTI IN DOPPIO STRATO E FUNI TONDE AD ANELLO

### NORMATIVA EUROPEA (Estratto del progetto 1492-1-2 luglio 1994)

Questa norma europea specifica l'applicazione di tutti gli apparecchi e gli accessori di sollevamento tessile, con le loro caratteristiche di fabbricazione. In conformità totale alle esigenze di sicurezza della direttiva macchine 89/392/CEE. Essa specifica inoltre il modo di fabbricazione, l'identificazione e la marcatura dei tiranti; essa permette di evidenziare le loro caratteristiche, di precisare il carico massimo di utilizzo (WLL-CMU) e di descrivere il metodo di verifica e obbligatorio specificare: il marchio CE, la dichiarazione di conformità, il modo di utilizzo.

**MOLTO IMPORTANTE:** per carico massimo di utilizzo (CMU) si intende il rispetto delle condizioni di utilizzo precisate nella PR NORMA 1492-1 e 1492-2

## PRESCRIZIONI DI SICUREZZA

- A) Coefficiente di sicurezza: 1:7 per nastri cuciti, 1:4 per accessori ed elementi di assemblaggio in ferro, 1:5 per accessori non ferrosi.
- B) Resistenza alla trazione: i tiranti cuciti devono resistere ad una forza minima uguale a 7 volte il carico massimo di utilizzo
- C) Codice di identificazione: permette di identificare gli elementi sotto descritti:
  - Il materiale utilizzato per la fabbricazione (poliester, poliammide, polipropilene)
  - la lunghezza in metri
  - Il nome o il simbolo preciso del fabbricante
  - Il codice di identificazione
  - Identificazione del mese ed anno di fabbricazione sull'etichetta.

## TIRANTE IN POLIESTERE DOPPIO STRATO DI NASTRO COLORI SECONDO NORME CEN COEFF. SICUREZZA 7:1



### art. 69 TIR 1000

MT. 2-3-4-5 ALTRE SU RICHIESTA



### art. 69 TIR 2000

MT. 3-4-5-6 ALTRE SU RICHIESTA



### art. 69 TIR 3000

MT. 3-4-5-6 ALTRE SU RICHIESTA



TABELLA PORTATE TIRANTI TIPO B STRATO DOPPIO					
C.M.U.*	carico in % 100%	carico in % 200%	carico in % 140%	carico in % 80%	carico in % 100%
1 T	1.000	2.000	1.400	800	1.000
2 T	2.000	4.000	2.800	1.600	2.000
3 T	3.000	6.000	4.200	2.400	3.000

A RICHIESTA PORTATE DISPONIBILI FINO A 20.000 KG IN DIVERSE LUNGHEZZE

FUNI TONDE AD ANELLO CONTINUO COD. ART. ELRO FILAMENTO IN POLIESTERE RIVESTIMENTO ESTERNO GUAINA IN POLIESTERE



**art. 69 FUN 1000**

MT. 2-3-4-5 ALTRE SU RICHIESTA



**art. 69 FUN 2000**

MT. 3-4-5-6 ALTRE SU RICHIESTA



**art. 69 FUN 3000**

MT. 3-4-5-6 ALTRE SU RICHIESTA



TABELLA PORTATE TIRANTI TIPO B STRATO DOPPIO					
C.M.U.*	carico in % 100%	carico in % 200%	carico in % 140%	carico in % 80%	carico in % 100%
1 T	1.000	2.000	1.400	800	1.000
2 T	2.000	4.000	2.800	1.600	2.000
3 T	3.000	6.000	4.200	2.400	3.000

A RICHIESTA PORTATE DISPONIBILI FINO A 40.000 KG IN DIVERSE LUNGHEZZE

DISPOSITIVI DI ANCORAGGIO

**art. 69 ANC 1**



**art. 69 ANC 2**

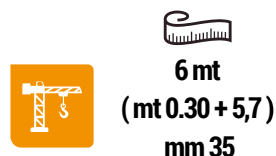

Dispositivo di ancoraggio serie 35 mm.  
Nastro in poliestere 100% alta tenacità.  
Larghezza del nastro mm.35.  
Tenditore in acciaio zincato.  
Tensione del nastro tramite azionamento della  
leva verso l'alto.  
Dispositivo idoneo al bloccaggio delle merci su  
veicoli medio piccoli.  
Portata massima 2 TON.  
Capacità di ancoraggio: 1000 daN

**art. 69 ANC 3**

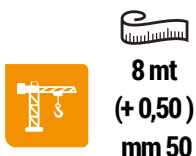

**art. 69 ANC H**

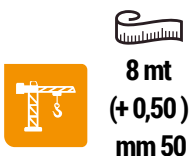

**NORMA DI RIFERIMENTO EN12195-2**

Dispositivo di ancoraggio serie 50 mm.  
Nastro in poliestere 100% alta tenacità.  
Larghezza del nastro mm.50.  
Tenditore in acciaio zincato.  
Tensione del nastro tramite azionamento della  
leva verso l'alto.  
Dispositivo idoneo al bloccaggio delle merci su  
veicoli industriali.  
Portata massima 5 TON.  
Capacità di ancoraggio: 2000 daN

# INDICE

Articoli da cantiere .....	pag. 360
Segnaletica .....	pag. 366
Specchi stradali.....	pag. 370
Cinture borse portattrezzi.....	pag. 371
Accessori attrezzi.....	pag. 373
Dossi stradali.....	pag. 374
Segnaletica stradale .....	pag. 375
Nastri cantieri.....	pag. 376
Filo per l'edilizia.....	pag. 378
Linea bombolette spray e vernici.....	pag. 379
Traccialinee.....	pag. 384
Cassette pronto soccorso.....	pag. 385



SEBA





**ARTICOLI DA CANTIERE**

**CASSETTE SOCCORSO**



## art. 3185



Impianto semaforico al LED "richiudibile" per sensi unici alternati, costituito da 2 carrelli mobili in lamiera zinca completi di ruote per il loro spostamento, atti a tenere la batteria di alimentazione (3185B NON inclusa) da 12V e le relative centraline elettroniche.

La sorgente luminosa dovrà essere costituita da minimo 80 led per colore, dovrà essere obbligatoriamente dotata di visiere parasole. Il carrello e la lanterna devono essere smontabili per facilitarne il trasporto e devono essere alloggiati sul carrello stesso. Il consumo dovrà essere non superiore a 0,5Ah. Lampade diametro 200 mm.

Pezzi 2 - alimentatore a parte (art. 3185B)

**Packing:** 1 coppia

**Imballo minimo per ordine:** 1 coppia

**Scatola:** 1 coppia - volume m<sup>3</sup> 0,60 - Peso Kg. 60

**Articolo dotato di codice a barre**

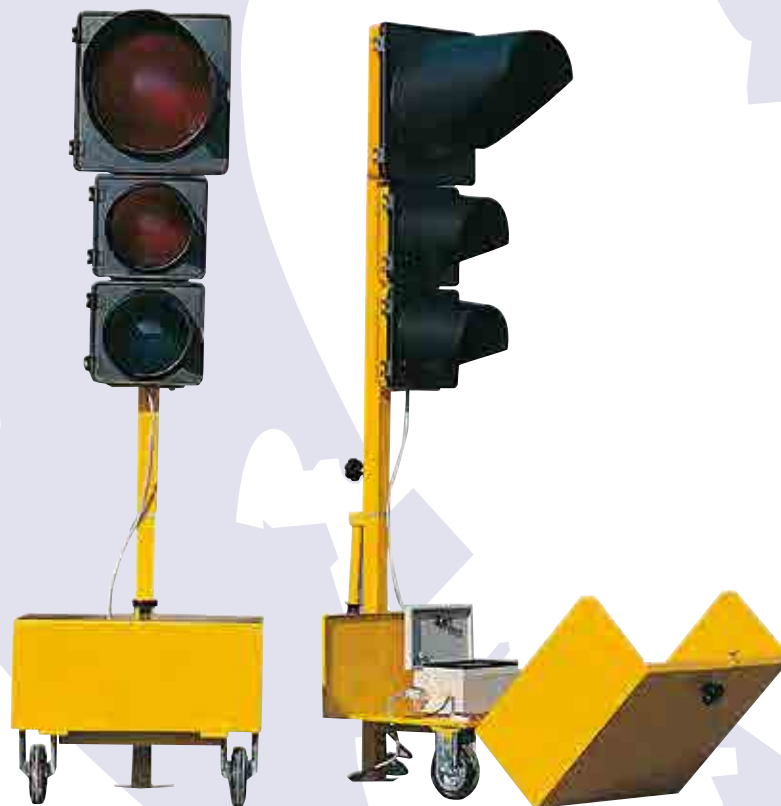

## art. 3185B



Batteria per Art. 3185

**Packing:** 1 pezzo

**Imballo minimo per ordine:** 2 pezzi

**Scatola:** 1 pezzo - volume m<sup>3</sup> 0,05 - Peso Kg. 3

**Articolo dotato di codice a barre**

## art. 3235 - 12V



Proiettore girevole 12 V - base piana senza prese accendisigari

**Packing:** 1 pezzo

**Imballo minimo per ordine:** 1 pezzo

**Scatola:** 1 pezzo - volume m<sup>3</sup> 0,03 - Peso Kg. 1,5

**Articolo dotato di codice a barre**



## art. 3237 - 24V



Proiettore girevole 24 V - base piana senza presa accendisigari

**Packing:** 1 pezzo

**Imballo minimo per ordine:** 1 pezzo

**Scatola:** 1 pezzo - volume m<sup>3</sup> 0,03 - Peso Kg. 1,5

**Articolo dotato di codice a barre**

## art. 3236 - 12V



Proiettore girevole 12 V - magnetico con presa accendisigari

**Packing:** 1 pezzo

**Imballo minimo per ordine:** 1 pezzo

**Scatola:** 1 pezzo - volume m<sup>3</sup> 0,03 - Peso Kg. 1,5

**Articolo dotato di codice a barre**



## art. 3238 - 24V



Proiettore girevole 24 V - magnetico con presa accendisigari

**Packing:** 1 pezzo

**Imballo minimo per ordine:** 1 pezzo

**Scatola:** 1 pezzo - volume m<sup>3</sup> 0,03 - Peso Kg. 1,5

**Articolo dotato di codice a barre**



## art. 3230C



8 011818 148572



Doppia lampada da cantiere completa di treppiedi - 2x500 W

**Packing:** 1 pezzo

**Imballo minimo per ordine:** 1 pezzo

**Scatola:** 1 pezzo - volume m<sup>3</sup> 0,10

**Peso Kg. 8**

**Articolo dotato di codice a barre**

## art. 3230B



8 011818 148565



Lampada da cantiere completa di treppiedi - 150 W

**Packing:** 1 pezzo

**Imballo minimo per ordine:** 1 pezzo

**Scatola:** 1 pezzo - volume m<sup>3</sup> 0,05

**Peso Kg. 5**

**Articolo dotato di codice a barre**

## art. 3230A



8 011818 148558



Lampada da cantiere completa di morsetto - W150

**Packing:** 1 pezzo

**Imballo minimo per ordine:** 1 pezzo

**Scatola:** 1 pezzo - volume m<sup>3</sup> 0,03 -

Peso Kg. 1,5

**Articolo dotato di codice a barre**

## art. 3230



8 011818 108231



Proiettore alogeno 220V 500W con supporto metallico.

Griglia di protezione Spina SCHUKO 16A 2P+T

**Packing:** 1 pezzo

**Imballo minimo per ordine:** 1 pezzo

**Scatola:** 1 pezzo - volume m<sup>3</sup> 0,05 -

Peso Kg. 3

**Articolo dotato di codice a barre**

## art. 3233L



8 011818 108439



Portallampada portatile con impugnatura in gomma, vetro di protezione e gabbia metallica con gancio, grado IP55, cavo H07-RNF, predisposizione per lampada E27 220V 100W.

**Packing:** 1 pezzo - **Imballo minimo per ordine:** 1 pezzo

**Scatola:** 1 pezzo - volume m<sup>3</sup> 0,05 - Peso Kg. 1,5

**Articolo dotato di codice a barre**

## art. 496A



8 011818 109993



Lampada a tubo segnalatrice L=54, luce L=34,5, diam.4, 2 funzioni Batterie non comprese

**Packing:** 1 pezzo

**Imballo minimo per ordine:** 1 pezzo

**Scatola:** 50 pezzi - volume m<sup>3</sup> 0,03 - Peso Kg. 1,20

**Articolo dotato di codice a barre**

### art. 496B



8 011818 110005

Torcia portatile - Batterie escluse

**Packing:** 1 pezzo

**Imballo minimo per ordine:** 1 pezzo

**Scatola:** 1 pezzo - volume m<sup>3</sup> 0,03 - Peso Kg. 1

**Articolo dotato di codice a barre**

### art. 208B



8 011818 109962

Luci laterali con stanghette

**Packing:** 24 pezzi

**Imballo minimo per ordine:** 24 pezzi

**Scatola:** 24 pezzi - volume m<sup>3</sup> 0,05 - Peso Kg. 4

**Articolo dotato di codice a barre**

### art. 3226



8 011818 107180

Batteria 6V 4R25 ecologica 0% mercurio.

Per articoli 495 - 495AR - 3241

**Packing:** 12 pezzi

**Imballo minimo per ordine:** 12 pezzi

**Scatola:** 12 pezzi - volume m<sup>3</sup> 0,05 - Peso Kg. 5

**Articolo dotato di codice a barre**

### art. 495AR



8 011818 108460

Lampada a luce fissa rossa - batterie escluse (pz. 2)

**Packing:** 1 pezzo

**Imballo minimo per ordine:** 1 pezzo

**Scatola:** 1 pezzo - volume m<sup>3</sup> 0,04 -

Peso Kg. 1,5

**Articolo dotato di codice a barre**

### art. 495



8 011818 106350

Lampada a luce intermittente gialla - batterie escluse (pz. 2)

**Packing:** 1 pezzo

**Imballo minimo per ordine:** 1 pezzo

**Scatola:** 1 pezzo - volume m<sup>3</sup> 0,04 -

Peso Kg. 1,5

**Articolo dotato di codice a barre**

### art. 717L



8 011818 171501

Lampada frontale a led (batterie non incluse)

**Imballo minimo per ordine:** 10 pz.

**Packaging:** 1 pz

**Volume scatola:** 0,05 m<sup>3</sup> (10 paia) Peso kg. 2

**Articolo dotato di codice a barre**

### art. 715L



8 011818 109986

Lampada frontale con set carica batteria - Durata batteria circa

10 mesi. La luce può raggiungere una distanza di circa 80 metri.

Lampadine da 6W o 7W

**Packing:** 1 pezzo

**Imballo minimo per ordine:** 1 pezzo

**Scatola:** 1 pezzo - volume m<sup>3</sup> 0,03 - Peso Kg. 1

**Articolo dotato di codice a barre**



### art. 716L



8 011818 109979

Lampada frontale utilizzabile con batterie a stilo (batterie non comprese - 4x1,5 volt).

**Packing:** 12 pezzi

**Imballo minimo per ordine:** 12 pezzi

**Scatola:** 12 pezzi - volume m<sup>3</sup> 0,05 - Peso Kg. 5

**Articolo dotato di codice a barre**



## art. 1000882



Quadro elettrico portatile:  
 2 prese 2P+T 16A  
 2 prese 3P+T 16A  
**Packing:** 1 pezzo  
**Imballo minimo per ordine:** 1 pezzo  
**Scatola:** 1 pezzo - volume m<sup>3</sup> 0,03 -  
 Peso Kg. 2,5  
**Articolo dotato di codice a barre**



8 033971 217728



## art. 1000883



Quadro elettrico portatile:  
 4 prese 2P+T 16A  
**Packing:** 1 pezzo  
**Imballo minimo per ordine:** 1 pezzo  
**Scatola:** 1 pezzo - volume m<sup>3</sup> 0,03 -  
 Peso Kg. 2,5  
**Articolo dotato di codice a barre**



8 033971 217506



## art. 3234T



8 011818 108392

Trasformatore portatile di sicurezza IP44  
 220V/24V 200VA a 2 prese CEE 24V 16A 2P  
 Spina CEE 220V 16A 2P+T  
**Packing:** 1 pezzo  
**Imballo minimo per ordine:** 1 pezzo  
**Scatola:** 1 pezzo - volume m<sup>3</sup> 0,07 - Peso Kg. 4  
**Articolo dotato di codice a barre**



## art. 1000884 - 220V



8 033971 210187

Avvolgicavo trifase:  
 - Tamburo in PVC  
 - 3 prese 2P+T 16A  
 - Disgiuntore termico  
 - Cavo Neoprene  
 LUNGHEZZA MT. 30  
**Packing:** 1 pezzo  
**Imballo minimo per ordine:** 1 pezzo  
**Scatola:** 1 pezzo - volume m<sup>3</sup> 0,05 -  
 Peso Kg. 6  
**Articolo dotato di codice a barre**



## art. 1000885 - 380V



8 033971 210279

Avvolgicavo trifase:  
 - Tamburo in PVC  
 - 3 prese 3P+T 16A  
 - Disgiuntore termico  
 - Cavo Neoprene  
 LUNGHEZZA MT. 30  
**Packing:** 1 pezzo  
**Imballo minimo per ordine:** 1 pezzo  
**Scatola:** 1 pezzo - volume m<sup>3</sup> 0,05 -  
 Peso Kg. 6  
**Articolo dotato di codice a barre**





**art. 1000886** Prolunga  
Monofase  
20 mt - 220 V



8 033971 218107



**art. 1000887** Prolunga  
Monofase  
30 mt - 220 V



8 033971 218169

**art. 1000888** Prolunga  
Trifase  
20 mt - 380 V



8 033971 218336



**art. 1000889** Prolunga  
Trifase  
30 mt - 380 V



8 033971 218398

**art. 3242**



8 011818 108354

Luci di ingombro per ponteggi - ad 1  
lampada - 24 volt

**Packing:** 1 kit

**Imballo minimo per ordine:** 1 kit

**Scatola:** 1 kit - volume m<sup>3</sup> 0,03 - Peso Kg. 1

**Articolo dotato di codice a barre**

**art. 3243**



8 011818 108361

Luci di ingombro per ponteggi - a 2 lampade

**Packing:** 1 kit

**Imballo minimo per ordine:** 1 kit

**Scatola:** 1 kit - volume m<sup>3</sup> 0,04 - Peso Kg. 1,2

**Articolo dotato di codice a barre**

**art. 3244**



8 011818 108378

Luci di ingombro per ponteggi - a 3 lampade

**Packing:** 1 kit

**Imballo minimo per ordine:** 1 kit

**Scatola:** 1 kit - volume m<sup>3</sup> 0,05 - Peso Kg. 2

**Articolo dotato di codice a barre**



# ARTICOLI DA CANTIERE SEGNALETICA

art. 3043



8 011818 132656

Cavalletto universale zincato

**Packing:** 1 pezzo

**Imballo minimo per ordine:** 1 pezzo

**Scatola:** 1 pezzo - volume m<sup>3</sup> 0,05 - Peso Kg. 3

**Articolo dotato di codice a barre**



# SEBA

art. 3001



8 011818 127652



Triangolo diam. 90 - LAVORI  
**Packing:** 1 pezzo  
**Imballo minimo per ordine:** 1 pezzo  
**Scatola:** 1 pezzo  
**Articolo dotato di codice a barre**

art. 3002



8 011818 127669



Triangolo diam. 90 -  
 STRETTOIA SIMMETRICA  
**Packing:** 1 pezzo  
**Imballo minimo per ordine:** 1 pezzo  
**Scatola:** 1 pezzo  
**Articolo dotato di codice a barre**

art. 3003



8 011818 132663



Triangolo diam. 90 - STRETTOIA  
 ASIMMETRICA A SINISTRA  
**Packing:** 1 pezzo  
**Imballo minimo per ordine:** 1 pezzo  
**Scatola:** 1 pezzo  
**Articolo dotato di codice a barre**

art. 3004



8 011818 127676



Triangolo diam. 90 -  
 STRETTOIA ASIMMETRICA A DESTRA  
**Packing:** 1 pezzo  
**Imballo minimo per ordine:** 1 pezzo  
**Scatola:** 1 pezzo  
**Articolo dotato di codice a barre**

art. 3005



8 011818 131956



Triangolo diam. 90 -  
 DOPPIO SENSO DI CIRCOLAZIONE  
**Packing:** 1 pezzo  
**Imballo minimo per ordine:** 1 pezzo  
**Scatola:** 1 pezzo  
**Articolo dotato di codice a barre**

art. 3006



8 011818 127683



Triangolo diam. 90 -  
 ALTRI PERICOLI  
**Packing:** 1 pezzo  
**Imballo minimo per ordine:** 1 pezzo  
**Scatola:** 1 pezzo  
**Articolo dotato di codice a barre**



art. 3007



8 011818 127713



Triangolo diam. 90  
STRADA DEFORMATA  
**Packing:** 1 pezzo  
**Imballo minimo per ordine:** 1 pezzo  
**Scatola:** 1 pezzo  
**Articolo dotato di codice a barre**

art. 3008



8 011818 127706



Triangolo diam. 90 - SEMAFORO  
**Packing:** 1 pezzo  
**Imballo minimo per ordine:** 1 pezzo  
**Scatola:** 1 pezzo  
**Articolo dotato di codice a barre**

art. 3009



8 011818 127690



Triangolo diam.90 - MATERIALE INSTABILE  
SULLA STRADA  
**Packing:** 1 pezzo  
**Imballo minimo per ordine:** 1 pezzo  
**Scatola:** 1 pezzo  
**Articolo dotato di codice a barre**

art. 2901A 41



8 011818 127775



Disco diam.60 - DARE PRECEDENZA  
NEI SENSI UNICI ALTERNATI  
**Packing:** 1 pezzo  
**Imballo minimo per ordine:** 1 pezzo  
**Scatola:** 1 pezzo  
**Articolo dotato di codice a barre**

art. 2903A 46

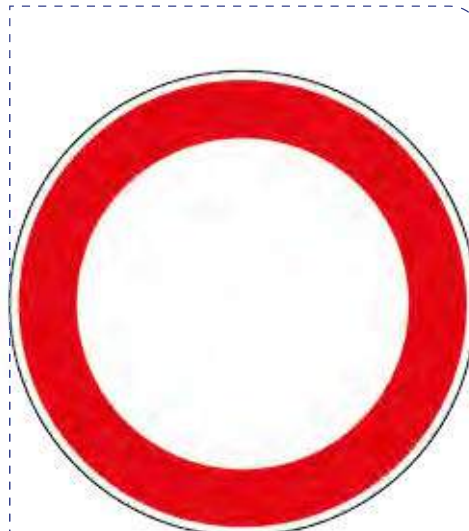

8 011818 127782



Disco diam.60 - DIVIETO DI TRANSITO  
**Packing:** 1 pezzo  
**Imballo minimo per ordine:** 1 pezzo  
**Scatola:** 1 pezzo  
**Articolo dotato di codice a barre**

art. 2905A 48



8 011818 127805



Disco diam.60 - DIVIETO DI SORPASSO  
**Packing:** 1 pezzo  
**Imballo minimo per ordine:** 1 pezzo  
**Scatola:** 1 pezzo  
**Articolo dotato di codice a barre**

art. 2906A 50



Disco diam. 60 -  
SPECIFICARE IL LIMITE RICHIESTO  
**Packing:** 1 pezzo  
**Imballo minimo per ordine:** 1 pezzo  
**Scatola:** 1 pezzo  
**Articolo dotato di codice a barre**

art. 2904A 47



Disco diam.60 - SENSO VIETATO  
**Packing:** 1 pezzo  
**Imballo minimo per ordine:** 1 pezzo  
**Scatola:** 1 pezzo  
**Articolo dotato di codice a barre**

art. 2907A 70

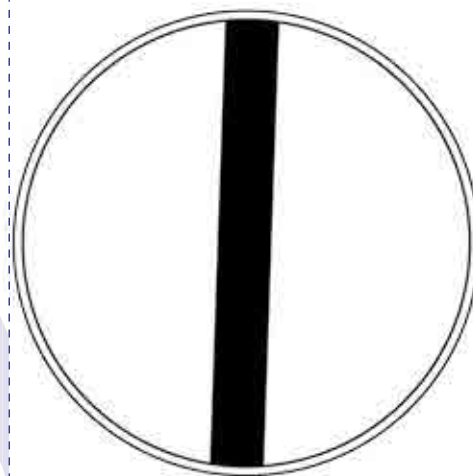

Disco diam. 60  
**Packing:** 1 pezzo  
**Imballo minimo per ordine:** 1 pezzo  
**Scatola:** 1 pezzo  
**Articolo dotato di codice a barre**

art. 2908A 74



Disco diam. 60 - DIVIETO DI SOSTA  
**Packing:** 1 pezzo  
**Imballo minimo per ordine:** 1 pezzo  
**Scatola:** 1 pezzo  
**Articolo dotato di codice a barre**

art. 2909 82



Disco diam. 60 -  
PASSAGGIO OBBLIGATORIO ( GIREVOLE )  
**Packing:** 1 pezzo  
**Imballo minimo per ordine:** 1 pezzo  
**Scatola:** 1 pezzo  
**Articolo dotato di codice a barre**

art. 2902 45



Targa 60x60 -  
DIRITTO DI PRECEDENZA  
**Packing:** 1 pezzo  
**Imballo minimo per ordine:** 1 pezzo  
**Scatola:** 1 pezzo  
**Articolo dotato di codice a barre**



art. 3136



Cupola di sorveglianza - diam. cm 60  
**Packing:** 1 pezzo  
**Imballo minimo per ordine:** 1 pezzo  
**Scatola:** 1 pezzo - volume m<sup>3</sup> 0,15 - Peso Kg. 2  
**Articolo dotato di codice a barre**

art. 3124



Specchio stradale diam. 50 cm  
**Packing:** 1 pezzo  
**Imballo minimo per ordine:** 1 pezzo  
**Scatola:** 1 pezzo - volume m<sup>3</sup> 0,10 - Peso Kg. 4  
**Articolo dotato di codice a barre**

art. 3126



Specchio stradale diam. 70 cm  
**Packing:** 1 pezzo  
**Imballo minimo per ordine:** 1 pezzo  
**Scatola:** 1 pezzo - volume m<sup>3</sup> 0,10 - Peso Kg. 6  
**Articolo dotato di codice a barre**

art. 3127



Specchio stradale diam. 80 cm  
**Packing:** 1 pezzo  
**Imballo minimo per ordine:** 1 pezzo  
**Scatola:** 1 pezzo - volume m<sup>3</sup> 0,15 - Peso Kg. 7  
**Articolo dotato di codice a barre**

art. 3137



Cupola di sorveglianza - diam. cm 80  
**Packing:** 1 pezzo  
**Imballo minimo per ordine:** 1 pezzo  
**Scatola:** 1 pezzo - volume m<sup>3</sup> 0,15 - Peso Kg. 4  
**Articolo dotato di codice a barre**

art. 3125



Specchio stradale diam. 60 cm  
**Packing:** 1 pezzo  
**Imballo minimo per ordine:** 1 pezzo  
**Scatola:** 1 pezzo - volume m<sup>3</sup> 0,10 - Peso Kg. 5  
**Articolo dotato di codice a barre**

art. 3128



Specchio stradale diam. 90 cm  
**Packing:** 1 pezzo  
**Imballo minimo per ordine:** 1 pezzo  
**Scatola:** 1 pezzo - volume m<sup>3</sup> 0,15 - Peso Kg. 8  
**Articolo dotato di codice a barre**

art. 8F



8 011818 095487



Borsa professionale in pelle fiore a 9 tasche  
**Packing:** 1 pezzo  
**Imballo minimo per ordine:** 1 pz  
**Scatola:** 10 pz - volume m<sup>3</sup> 0,05 - Peso Kg. 8  
**Articolo dotato di codice a barre**

art. 9



8 011818 124408



Fondina in cuoio per pistola pneumatica (senza cintura)  
**Packing:** 1 pezzo  
**Imballo minimo per ordine:** 10 pz  
**Scatola:** 10 pz - volume m<sup>3</sup> 0,05 - Peso Kg. 3  
**Articolo dotato di codice a barre**

art. 16B



8 011818 095494



Borsa doppia in pelle fiore a 11 tasche  
**Packing:** 1 pezzo  
**Imballo minimo per ordine:** 1 pz  
**Scatola:** 6 pz - volume m<sup>3</sup> 0,08 - Peso Kg. 12  
**Articolo dotato di codice a barre**

art. 16



8 011818 095531



Borsa a 10 tasche in nylon rinforzato  
**Packing:** 6 pezzi  
**Imballo minimo per ordine:** 6 pz  
**Scatola:** 6 pz - volume m<sup>3</sup> 0,08 - Peso Kg. 8  
**Articolo dotato di codice a barre e confezione appendibile**

art. 8M

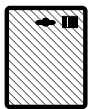

8 011818 095562

Borsa a 9 tasche in nylon rinforzato

**Packing:** 1 pezzo  
**Imballo minimo per ordine:** 10 pz

**Scatola:** 10 pz - volume m<sup>3</sup> 0,08 - Peso Kg. 6

**Articolo dotato di codice a barre e confezione appendibile**



art. 90C



8 011818 095623

Cintura in polipropilene

**Packing:** 10 pezzi  
**Imballo minimo per ordine:** 10 pz

**Scatola:** 10 pz - volume m<sup>3</sup> 0,05 - Peso Kg. 1,5

**Articolo dotato di codice a barre**



art. 9E



8 011818 095609

Supporto per pinza in nylon rinforzato

**Packing:** 1 pezzo  
**Imballo minimo per ordine:** 10 pz

**Scatola:** 10 pz - volume m<sup>3</sup> 0,05 - Peso Kg. 2

**Articolo dotato di codice a barre**



art. 9F



8 011818 095616

Supporto per nastro adesivo o metro in nylon rinforzato

**Packing:** 1 pezzo  
**Imballo minimo per ordine:** 15 pz

**Scatola:** 15 pz - volume m<sup>3</sup> 0,05 - Peso Kg. 1,5

**Articolo dotato di codice a barre**



art. 90D



8 011818 095630

Porta martello in nylon rinforzato

**Packing:** 12 pezzi  
**Imballo minimo per ordine:** 12 pz

**Scatola:** 12 pz - volume m<sup>3</sup> 0,05 - Peso Kg. 2

**Articolo dotato di codice a barre**



art. 66A



8 011818 125184

Bauletto per idraulici - cm 40

**Packing:** 1 pezzo  
**Imballo minimo per ordine:** 1 pz

**Scatola:** 1 pz - volume m<sup>3</sup> 0,03 - Peso Kg. 4

**Articolo dotato di codice a barre**

art. 66B



8 011818 125191

Bauletto per idraulici - cm 55

**Packing:** 1 pezzo  
**Imballo minimo per ordine:** 1 pz

**Scatola:** 1 pz - volume m<sup>3</sup> 0,04 - Peso Kg. 5

**Articolo dotato di codice a barre**

art. 65A



8 011818 124972

Borsa per elettricista - cm 35

**Packing:** 1 pezzo  
**Imballo minimo per ordine:** 1 pz

**Scatola:** 1 pz - volume m<sup>3</sup> 0,03 - Peso Kg. 4

**Articolo dotato di codice a barre**

art. 65C



8 011818 124941

Borsa per elettricista - cm 45

**Packing:** 1 pezzo  
**Imballo minimo per ordine:** 1 pz

**Scatola:** 1 pz - volume m<sup>3</sup> 0,04 - Peso Kg. 5

**Articolo dotato di codice a barre**

art. 65B



8 011818 124934

Borsa per elettricista - cm 40

**Packing:** 1 pezzo  
**Imballo minimo per ordine:** 1 pz

**Scatola:** 1 pz - volume m<sup>3</sup> 0,03 - Peso Kg. 4

**Articolo dotato di codice a barre**

art. 6-GEC



Fascia lombare elasticizzata con bretelle misura regolabile tramite velcro.  
**Packing:** 1 pezzo - **Taglie:** L - XL  
**Imballo minimo per ordine:** 1 pezzo  
**Scatola:** 10 pz - volume m<sup>3</sup> 0,05 - peso kg.2  
**Articolo dotato di codice a barre**



art. 6-G2R



Ginocchiere in gomma  
**Packing:** 1 paio  
**Imballo minimo per ordine:** 10 paia  
**Scatola:** 10 paia - volume m<sup>3</sup> 0,08 -  
 Peso Kg. 8  
**Articolo dotato di codice a barre**



art. 09



Ascia in acciaio - manico legno cm 90 Peso kg 3,5 circa  
**Packing:** 1 pezzo  
**Imballo minimo per ordine:** 1 pz  
**Scatola:** 1 pz - volume m<sup>3</sup> 0,03 - Peso Kg. 3,5 circa  
**Articolo dotato di codice a barre**

art. 010



Piccozzina di acciaio con manico in legno - kg 1  
**Packing:** 1 pezzo  
**Imballo minimo per ordine:** 1 pz  
**Scatola:** 1 pz - volume m<sup>3</sup> 0,03 -  
 Peso Kg. 1  
**Articolo dotato di codice a barre**

art. 017



Pala pieghevole antiscintilla in alluminio cm 105  
**Packing:** 1 pezzo  
**Imballo minimo per ordine:** 1 pz  
**Scatola:** 1 pz - volume m<sup>3</sup> 0,05 -  
 Peso Kg. 2  
**Articolo dotato di codice a barre**

art. 011



Fondina in cuoio per piccozzina  
**Packing:** 1 pezzo  
**Imballo minimo per ordine:** 1 pz  
**Scatola:** 1 pz - volume m<sup>3</sup> 0,03 - Peso Kg. 0,5  
**Articolo dotato di codice a barre**

art. 58000



8 011818 148053



Passacavo medio  
 Dimensioni: mm 845x302x70 (altezza)  
**Packing:** 5 pezzi  
**Imballo minimo per ordine:** 5 pz  
**Scatola:** 5 pezzi - volume m<sup>3</sup> 0,50 - Peso Kg. 65  
**Articolo dotato di codice a barre**

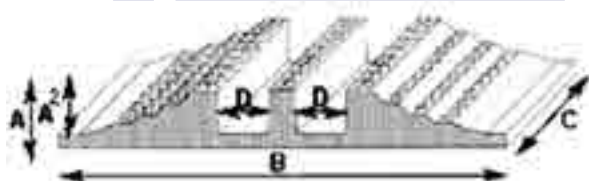

	A	A2	B	C	D
medio	92	70	845	302	90
maxi	142	120	992	284	140

art. 58000 - M



8 011818 148060



Passacavo maxi  
 Dimensioni: mm 992x284x120 (altezza)  
**Packing:** 5 pezzi  
**Imballo minimo per ordine:** 5 pz  
**Scatola:** 5 pezzi - volume m<sup>3</sup> 0,50 - Peso Kg. 65  
**Articolo dotato di codice a barre**

art. 58100



8 011818 133158



Passacavo mini  
 Dimensioni: mm 400x300x60 (altezza)  
**Packing:** 10 pezzi  
**Imballo minimo per ordine:** 10 pz  
**Scatola:** 10 pezzi - volume m<sup>3</sup> 0,30 - Peso Kg. 60  
**Articolo dotato di codice a barre**



	A	B	C	D
MINI	60	400	300	302

art. 68700

[DM 3195 del 14/11/1994]



8 011818 127621



Dozzo h cm 3 compreso di tasselli di fissaggio (base cm 47,5 x lunghezza cm 60 x altezza cm 3)  
**Packing:** 1 pezzo per confezione  
**Imballo minimo per ordine:** 1 pezzo  
**Scatola:** 1 pezzo - volume m<sup>3</sup> 0,05 - Peso Kg. 9  
**Articolo dotato di codice a barre**



Art. 29123

Art. 74054

Art. 29120

art. 29120



8 011818 127638



Terminale femmina per dozzo h cm 5, compreso di tasselli (27cm x 90cm)  
**Packing:** 1 pezzo per confezione  
**Imballo minimo per ordine:** 1 pezzo  
**Scatola:** 1 pezzo - volume m<sup>3</sup> 0,05 - Peso Kg. 8  
**Articolo dotato di codice a barre**

art. 74054

[DM 698 del 31/03/98]



8 011818 133196



Dozzo h cm 5, compreso di tasselli di fissaggio (base cm 50 x lunghezza cm 90 x altezza cm 5)  
**Packing:** 1 pezzo per confezione - **Imballo minimo per ordine:** 1 pezzo  
**Scatola:** 1 pezzo - volume m<sup>3</sup> 0,10 - Peso Kg. 16,6  
**Articolo dotato di codice a barre**

art. 29123



8 011818 127645



Terminale maschio per dozzo h cm 5, compreso di tasselli (27cm x 90cm)  
**Packing:** 1 pezzo per confezione  
**Imballo minimo per ordine:** 1 pezzo  
**Scatola:** 1 pezzo - volume m<sup>3</sup> 0,05 - Peso Kg. 8  
**Articolo dotato di codice a barre**



art. 56427



8 011818 148282



Dosso h cm 7 - compreso di tasselli  
(base cm 50 x lung. cm 120 x alt. cm 7)

**Packing:** 1 pezzo per confezione  
**Imballo minimo per ordine:** 1 pezzo  
**Scatola:** 1 pezzo - volume m<sup>3</sup> 0,06 - Peso Kg. 10  
**Articolo dotato di codice a barre**

art. 56431



8 011818 148305



Terminale per dosso h cm 7

**Packing:** 1 pezzo per confezione  
**Imballo minimo per ordine:** 1 pezzo  
**Scatola:** 1 pezzo - volume m<sup>3</sup> 0,03 - Peso Kg. 5  
**Articolo dotato di codice a barre**

art. 1930



8 011818 106343



Delimitatori angoli in pvc  
cm 30 - Nero

**Packing:** 1 pezzo  
**Imballo minimo per ordine:** 1 pz.  
**Scatola:** 1 pezzo - volume m<sup>3</sup> 0,03 - Peso Kg. 1  
**Articolo dotato di codice a barre**

art. 1931



8 011818 132953



Delimitatori angoli in pvc  
cm.30 - Giallo

**Packing:** 1 pezzo  
**Imballo minimo per ordine:** 1 pz.  
**Scatola:** 1 pezzo - volume m<sup>3</sup> 0,03 - Peso Kg. 1  
**Articolo dotato di codice a barre**

art. 501P50



8 011818 107210



Cono bianco e rosso in pvc -  
Altezza cm 50 Base cm 22 x 22

**Packing:** 1 pezzo  
**Imballo minimo per ordine:**  
10 pezzi  
**Scatola:** 10 pezzi - volume m<sup>3</sup>  
0,15 - Peso Kg. 10  
**Articolo dotato di  
codice a barre**

art. 501P30



8 011818 124903



Cono bianco e rosso in pvc -  
Altezza cm30 Base cm 22 x 22

**Packing:** 1 pezzo  
**Imballo minimo per ordine:** 20 pezzi  
**Scatola:** 20 pezzi - volume m<sup>3</sup> 0,15 - Peso Kg. 10  
**Articolo dotato di codice a barre**

art. 3226A



8 011818 135039



Cono in gomma con  
3 bande rifrangenti- h 50 - classe 1

**Packing:** 1 pezzo  
**Imballo minimo per ordine:** 1 pezzo  
**Scatola:** 1 pezzo - volume m<sup>3</sup> 0,05 - Peso Kg. 3,5  
**Articolo dotato di codice a barre**

art. 3076



8 011818 134018



Cono in gomma con  
2 bande rifrangenti -H. 30cm classe 1

**Packing:** 1 pezzo  
**Imballo minimo per ordine:** 1 pezzo  
**Scatola:** 1 pezzo - volume m<sup>3</sup> 0,04 - Peso Kg. 3  
**Articolo dotato di codice a barre**

### art. 3229



Delineatore riflettente flessibile in gomma a 6 inserti classe 2  
**Packing:** 1 pezzo  
**Imballo minimo per ordine:** 1 pezzo  
**Scatola:** 1 pezzo - volume m<sup>3</sup> 0,03 - Peso Kg. 1  
**Articolo dotato di codice a barre**

### art. 503



Catenella in pvc bianca e rossa  
 Ø mm. 6 - mt 25 - Peso Kg. 1,70  
**Packing:** 25 mt.  
**Imballo minimo per ordine:** 25 mt  
**Scatola:** 25 mt - volume m<sup>3</sup> 0,08 - Peso Kg. 2,0  
**Articolo dotato di codice a barre**

### art. 503S



Giunzione in pvc a "S" per art. 503.  
 Conf. 25 pezzi  
**Packing:** 1 conf. da 25 pezzi  
**Imballo minimo per ordine:** 1 conf. da 25 pezzi  
**Scatola:** 1 conf. da 25 pezzi - volume m<sup>3</sup> 0,05 - Peso Kg. 1,5  
**Articolo dotato di codice a barre**

### art. 484P



Colonnina in pvc - bianca e rossa  
 Altezza 90 cm diam. cm 4 - base 29x29 in cemento  
**Packing:** 1 pezzo  
**Imballo minimo per ordine:** 16 pezzi  
**Scatola:** 16 pezzi - volume m<sup>3</sup> 0,15 - Peso Kg. 10  
**Articolo dotato di codice a barre**

### art. 108LS



Nastro polietilene bianco/rosso - H. cm7  
 Spessore mm 0,04 - m 200 c/scatola  
**Packing:** 24 rotoli  
**Imballo minimo per ordine:** 24 rotoli  
**Scatola:** 24 rotoli - volume m<sup>3</sup> 0,20 - Peso Kg. 15  
**Articolo dotato di codice a barre**

### art. 108L



Nastro polietilene bianco/rosso - H. cm 7  
 Spessore mm 0,04 - m 200  
**Packing:** 1 rotolo  
**Imballo minimo per ordine:** 36 rotoli  
**Scatola:** 36 rotoli - volume m<sup>3</sup> 0,15 - Peso Kg. 15  
**Articolo dotato di codice a barre**



### art. 108A



Tubo acqua Nastro segnaletico in politene,  
 H cm10 Lunghezza m 200 - Spessore mm 0,07  
**Packing:** 1 rotolo  
**Imballo minimo per ordine:** 20 rotoli  
**Scatola:** 20 rotoli - volume m<sup>3</sup> 0,15 Peso Kg. 13  
**Articolo dotato di codice a barre**

### art. 108G

Nastro segnaletico Tubo GAS



### art. 108E

Nastro Tubo CAVO ELETTRICO



### art. 108T

Nastro CAVO TELEFONICO



### art. 108F

Nastro segnaletico Tubo FOGNATURA



art. 3167



Paletta per moviere- diametro mm. 300  
**Packing:** 1 pezzo  
**Imballo minimo per ordine:** 1 pezzo  
**Scatola:** 1 pezzo - volume m<sup>3</sup> 0,03  
 Peso Kg. 0,5  
**Articolo dotato di codice a barre**

art. 3164



Bandierina fluorescente cm. 60x80  
 manico in legno  
**Packing:** 1 pezzo  
**Imballo minimo per ordine:** 1 pezzo  
**Scatola:** 1 pezzo - volume m<sup>3</sup> 0,03 - Peso Kg. 1  
**Articolo dotato di codice a barre**

art. 3166



Torcia a mano tipo autostrada, cm. 80.  
 Durata 4 ore  
**Packing:** 1 pezzo  
**Imballo minimo per ordine:** 1 pezzo  
**Scatola:** 50 pezzi - volume m<sup>3</sup> 0,03  
 Peso Kg. 0,5  
**Articolo dotato di codice a barre**

art. 497



Sacco zavorra vuoto  
 - cm 40x60 con tappo  
**Packing:** 1 pezzo  
**Imballo minimo per ordine:** 1 pezzo  
**Scatola:** 1 pezzo  
 - volume m<sup>3</sup> 0,05 -  
 Peso Kg. 1  
**Articolo dotato di codice a barre**

art. 3156



Fettuccia metrica  
 m 20  
**Packing:** 1 pezzo  
**Imballo minimo per ordine:** 1 pezzo  
**Scatola:** 1 pezzo  
 - volume m<sup>3</sup> 0,05 -  
 Peso Kg. 1  
**Articolo dotato di codice a barre**

art. 3154



Palina esagonale in legno -  
 diam. 28 mm a punta metallica  
**Lunghezza cm 150**  
**Packing:** 6 pezzi  
**Imballo minimo per ordine:** 6 pezzi  
**Scatola:** 6 pezzo - volume m<sup>3</sup> 0,15  
 Peso Kg. 3  
**Articolo dotato di codice a barre**

art. 3239



Coprigiunto ortogonale per ponteggio, in  
 polipropilene colore arancio fluo  
**Packing:** 1 pezzo  
**Imballo minimo per ordine:** 1 pezzo  
**Scatola:** 1 pezzo - volume m<sup>3</sup> 0,03 - Peso Kg. 1  
**Articolo dotato di codice a barre**

### art. 525F



8 017991 080197



Filo per edilizia m 50 giallo fluo

**Packing:** 60 pezzi

**Imballo minimo per ordine:** 60 pezzi

**Scatola:** 60 pezzi - volume m<sup>3</sup> 0,10 - Peso Kg. 12

**Articolo dotato di codice a barre**

### art. 513



8 017991 080401



Filo per edilizia m 25

**Packing:** 120 rotoli

**Imballo minimo per ordine:** 120 rotoli

**Scatola:** 120 rotoli - volume m<sup>3</sup> 0,15 - Peso Kg. 12

**Articolo dotato di codice a barre**

### art. 524



8 017991 030017



Filo edile treccina - m 100

**Packing:** 1 pezzo

**Imballo minimo per ordine:** 24 pezzi

**Scatola:** 24 pezzi - volume m<sup>3</sup> 0,10 - Peso Kg. 10

**Articolo dotato di codice a barre**

### art. 515



8 017991 080326



Filo per edilizia m 500

**Packing:** 16 pezzi

**Imballo minimo per ordine:** 16 pezzi

**Scatola:** 16 pezzi - volume m<sup>3</sup> 0,10

Peso Kg. 12

**Articolo dotato di codice a barre**

### art. 515A



8 017991 080319



Filo per edilizia m 100 bianco

**Packing:** 32 pezzi

**Imballo minimo per ordine:** 32 pezzi

**Scatola:** 32 pezzi - volume m<sup>3</sup> 0,10 - Peso Kg. 10

**Articolo dotato di codice a barre**

### art. 523G



8 017991 080210



Filo per edilizia m 250 giallo

**Packing:** 16 pezzi

**Imballo minimo per ordine:** 16 pezzi

**Scatola:** 16 pezzi - volume m<sup>3</sup> 0,10 - Peso Kg. 9

**Articolo dotato di codice a barre**

### art. 514



8 017991 080302



Filo per edilizia m 50 - bianco

**Packing:** 72 rotoli

**Imballo minimo per ordine:** 72 rotoli

**Scatola:** 72 rotoli - volume m<sup>3</sup> 0,15 -

Peso Kg. 12

**Articolo dotato di codice a barre**

### art. 523B



8 017991 080036



Filo per edilizia m 250

**Packing:** 16 pezzi

**Imballo minimo per ordine:** 16 pezzi

**Scatola:** 16 pezzi - volume m<sup>3</sup> 0,10 - Peso Kg. 9

**Articolo dotato di codice a barre**

### art. 514V



8 017991 080111



Filo per edilizia m 50 verde

**Packing:** 40 pezzi

**Imballo minimo per ordine:** 40 pz

**Scatola:** 40 pezzi - volume m<sup>3</sup> 0,10 - Peso Kg. 10

**Articolo dotato di codice a barre**



TRACCE

VERNICI  
LINEA SPRAY



## art. 152



8 011818 090512



GRASSO AL LITIO MILLEUSI (ITA) Lubrificante grasso d'impiego generale di lunga durata con elevate proprietà antiusura e anticorrosive. Spray universale ad elevato potere lubrificante, ottimo per catene ed ingranaggi, funi cremagliere e cuscinetti, aderisce a tutte le superfici in movimento. Può essere applicato anche su zone umide grazie alle sue caratteristiche idrorepellenti. Utile nelle industrie, nella nautica, nell'edilizia, nel settore ferroviario e in lavori di manutenzione della casa e dell'auto. (Imballo 12 pezzi)

**Packing:** 12 pz.

**Imballo minimo per ordine:** 12 pz.

**Scatola:** 12 pz. - volume m<sup>3</sup> 0,08

**peso Kg. 8**

**Articolo dotato di codice a barre**

## art. 154



8 011818 090536



SVITO'S (ITA) È un penetrante super attivo che in pochi istanti permette lo sbloccaggio di viti, dadi, bulloni, raccordi, cerniere, ecc..., vincendo ogni resistenza su qualsiasi parte meccanica. Non attacca metalli e vernici. Protegge da ulteriori ossidazioni. (Imballo 12 pezzi)

**Packing:** 12 pz.

**Imballo minimo per ordine:** 12 pz.

**Scatola:** 12 pz. - volume m<sup>3</sup> 0,08 - peso Kg. 8

**Articolo dotato di codice a barre**

## art. 156



8 011818 090550



PULITORE PER CONTATTI (ITA) Solvente dielettrico, rimuove velocemente e completamente grasso, olio, pece, cera, adesivi e morchie dalle apparecchiature elettriche ed elettroniche, schede e sistemi d'allarme, anche durante il funzionamento. Non intacca i metalli, la gomma, le materie plastiche, il vetro e le vernici, senza lasciare residui, evapora rapidamente. Ideale anche quale detergente in tutti i casi ove non sia possibile usare soluzioni acquose, oppure sia necessaria l'asciugatura spontanea e rapida delle parti. (Imballo 12 pezzi)

**Packing:** 12 pz.

**Imballo minimo per ordine:** 12 pz.

**Scatola:** 12 pz. - volume m<sup>3</sup> 0,08 - peso Kg. 8

**Articolo dotato di codice a barre**

## art. 153



8 011818 090529



OLIO DI VASELINA (ITA) È un olio purissimo particolarmente pregiato sia per le sue proprietà di penetrazione che di anticorrosione. È indicato per parti meccaniche di elevata precisione, tipo organi per macchine da cucire, orologeria, ecc... E' inodore, atossico e multiuso. (Imballo 12 pezzi)

**Packing:** 12 pz.

**Imballo minimo per ordine:** 12 pz.

**Scatola:** 12 pz. - volume m<sup>3</sup> 0,08

**peso Kg. 8**

**Articolo dotato di codice a barre**

## art. 155



8 011818 090543



SILICONE SPRAY (ITA) Antiadesivo distaccante, lubrificante, protettivo a base di siliconi ad alto peso molecolare. Idrorepellente, elimina anche attriti e cigolii. Trova impiego nella sfornatura di manufatti plastici ed in gomma e nella lubrificazione di linee di produzione, anche alimentari; nelle industrie tessili, imballaggi, carta tecniche, falegnamerie, scivolante per nastri trasportatori. Non sporca le superfici. (Imballo 12 pezzi)

**Packing:** 12 pz.

**Imballo minimo per ordine:** 12 pz.

**Scatola:** 12 pz. - volume m<sup>3</sup> 0,08 - peso Kg. 8

**Articolo dotato di codice a barre**

## art. 157



8 011818 090567



CERCA FUGHE GAS (ITA) Il Cerca Fughe serve per prove di tenuta di saldature, valvole, pompe, contenitori sotto pressione, caldaie, tubature, bombole d'acciaio ed in genere per qualsiasi apparecchio soggetto a tenuta. Nella costruzione di tubature di gas ad alte pressioni, saldate o senza saldature. Per condotte di gas a media e bassa pressione, per scoprire le più piccole fessure e pori di saldatura. (Imballo 12 pezzi)

**Packing:** 12 pz.

**Imballo minimo per ordine:** 12 pz.

**Scatola:** 12 pz. - volume m<sup>3</sup> 0,08 - peso Kg. 8

**Articolo dotato di codice a barre**



## art. 158



8 011818 090574



**SVERNICIATORE (ITA)** Sverniciatore Spray ad azione rapida applicabile su qualsiasi superficie metallica e legno. Prodotto per usi industriali, bricolage, ecc... di estrema rapidità ed efficacia sia su smalti sintetici ed acrilici, bicomponenti, poliuretani ed epossilici. Rimuove totalmente i vecchi strati di vernice lasciando al superficie perfettamente pulita e pronta per un nuovo trattamento. Esente da cloruro di metilene/Alcool metilico/Componenti irritanti e nocivi. (Imballo 12 pezzi)

**Packing:** 12 pz.

**Imballo minimo per ordine:** 12 pz.

**Scatola:** 12 pz. - volume m<sup>3</sup> 0,08 - peso Kg. 8

**Articolo dotato di codice a barre**

## art. 160



8 011818 090598



**ANTISPRUZZO (ITA)** Antispruzzo speciale per saldature non siliconico. Prodotto di sintesi ad alto peso molecolare espressamente sintetizzato quale agente antispruzzo per saldature a filo continuo. Evita lo scintillio e la formazione di gocce di riporto. Non interferisce sulle eventuali operazioni di verniciatura. (Imballo 12 pezzi)

**Packing:** 12 pz.

**Imballo minimo per ordine:** 12 pz.

**Scatola:** 12 pz. - volume m<sup>3</sup> 0,08 - peso Kg. 8

**Articolo dotato di codice a barre**

## art. 162



8 011818 090611



**GHIACCIO SINTETICO (ITA)** Erogato sulla superficie epidermica. Il Ghiaccio Sintetico determina un immediato raffreddamento della zona, assai gradito in tutti quei casi di piccoli incidenti ove la benefica applicazione del freddo possa in qualche modo contribuire ad arrecare una sensazione di temporaneo sollievo e ad aiutare la ripresa dell'esercizio. (Imballo 12 pezzi)

**Packing:** 12 pz.

**Imballo minimo per ordine:** 12 pz.

**Scatola:** 12 pz. - volume m<sup>3</sup> 0,08 - peso Kg. 8

**Articolo dotato di codice a barre**

## art. 159



8 011818 090581



**LEVASILICONE (ITA)** Solvente specifico per la rimozione di residui di silicone. Rapido efficace per la rimozione di sfridi e residui di lavorazione di silicone e/o mastice anche rappreso. Ideale sia per il professionista che il privato. Sul silicone fresco agisce rapidamente. In presenza di alti spessori di silicone indurito rimuovere la parte eccedente con l'aiuto di una lametta, quindi spruzzare 2 o 3 volte ed attendere qualche minuto prima di strofinare (Imballo 12 pezzi)

**Packing:** 12 pz.

**Imballo minimo per ordine:** 12 pz.

**Scatola:** 12 pz. - volume m<sup>3</sup> 0,08 - peso Kg. 8

**Articolo dotato di codice a barre**

## art. 161



8 011818 090604



**IMPERMEABILIZZANTE (ITA)** Soluzione idro e oleorepellente. Non contiene siliconi. Adatto alle impermeabilizzazioni di: a) scarpe di pelle o scamosciato, giubbotti di camoscio, renna, pelle; b) tessuti anche delicati come seta, lino, viscosa, nylon, senza che le caratteristiche di morbidezza e di colore del materiale ne risentano; c) ogni tipo di indumento esterno quali giacche e pantaloni, specie nella parte inferiore più esposta alla pioggia e agli spruzzi, cappelli di ogni tipo (anche in paglia); d) tessuti di arredamento: pelle, alcantara e simili, tende da sole, ombrelloni, sdraio; e) capotte di autoveicoli e motoscafi.

**Packing:** 12 pz.

**Imballo minimo per ordine:** 12 pz.

**Scatola:** 12 pz. - volume m<sup>3</sup> 0,08 - peso Kg. 8

**Articolo dotato di codice a barre**

## art. 163



8 011818 090628



**PASTA VERDE PER IDRAULICI (ITA)** Pasta per la sigillatura dei giunti e raccordi filettati delle condotte d'acqua e gas. Durevolmente elastica. Non essicca e non indurisce col tempo. Resiste alle vibrazioni. È autosigillante. Non sporca e non imbratta. È possibile smontare prontamente il giunto senza problemi ed eventualmente rimontarlo grazie al suo potere lubrificante e protettivo. (Imballo 12 pezzi)

**Packing:** 12 pz.

**Imballo minimo per ordine:** 12 pz.

**Scatola:** 12 pz. - volume m<sup>3</sup> 0,08 - peso Kg. 8

**Articolo dotato di codice a barre**

## art. 164



8 011818 090635



ZINCO 96% (ITA) Lega di zinco per galvanostegia a freddo, altamente resistente alla corrosione degli agenti atmosferici come salsedine ed acqua. Ideale per l'applicazione su giunti saldati, tubazioni e serbatoi per impianti chimici, pompe tralacci e opere di carpenteria. Lo ZINCO Spray assicura a qualsiasi superficie metallica una completa galvanizzazione. Si presta ottimamente a ritocchi in fase di rifinitura. (Imballo 12 pezzi)

**Packing:** 12 pz.

**Imballo minimo per ordine:** 12 pz.

**Scatola:** 12 pz. - volume m<sup>3</sup> 0,08 - peso Kg. 8

**Articolo dotato di codice a barre**

## art. 165



8 011818 090642



OLIO DA TAGLIO (ITA) Indispensabile per filettare, trapanare, segare. Olio di elevata viscosità per impiego ad altissime pressioni. Se spruzzato sul filo della lama assicura una lubrificazione continua nelle operazioni di taglio. Applicato sul punto da trapanare, resta aderente ad ogni tipo di superficie. Permette ogni tipo di filettatura con la massima facilità e senza sprechi. (Imballo 12 pezzi)

**Packing:** 12 pz.

**Imballo minimo per ordine:** 12 pz.

**Scatola:** 12 pz. - volume m<sup>3</sup> 0,08 - peso Kg. 8

**Articolo dotato di codice a barre**

## art. 166



8 011818 090659



166 W100 QUALITA' (Tipo Magik) (ITA) Lubrifica e sblocca meccanismi ossidati, penetra in profondità, scioglie la ruggine, grassi, catrame, elimina le impronte digitali, le dispersioni elettriche e consente l'avviamento di motori bagnati. Per tutti i settori industriali, per auto, moto, imbarcazioni, per la casa, per armi, ecc... W100 Qualità è 5 Prodotti Essenziali in un unico Prodotto: Elimina l'acqua: penetra sotto l'umidità di superficie e crea una barriera protettiva tra l'umidità e il metallo; Penetra: l'ultra elevata attrazione di superficie del W 100 Qualità fa sì che gli ingredienti lubrificanti nel prodotto siano ampiamente dispersi e tenacemente attaccati alle parti mobili; Lubrifica: è un lubrificante tenace che, non contenendo silicone, non attrarrà le impurità e la polvere ed è quindi ideale per tutti i meccanismi piccoli; Anti-corrosivo: il prodotto deposita ingredienti anticorrosivi su tutta la superficie trattata, incluse le irregolarità microscopiche, creando in tal modo un effetto barriera contro l'umidità ed altri elementi corrosivi; Agente detergente: W 100 Qualità penetra sotto lo sporco, il grasso accumulato e l'olio fino a pulire la superficie. Inoltre elimina i cigolii, avvia i motori bagnati, protegge dalla corrosione, allenta meccanismi bloccati, pulisce e dissolve grassi e catrame. (Imballo 12 pezzi)

**Packing:** 12 pz.

**Imballo minimo per ordine:** 12 pz.

**Scatola:** 12 pz. - volume m<sup>3</sup> 0,08 - peso Kg. 8

**Articolo dotato di codice a barre**

## art. 167



8 011818 090666



ARIA COMPRESSA (ITA) Sostituisce il compressore generando un flusso d'aria ad alta pressione per rimuovere sporcizia e corpi estranei dai particolari difficilmente raggiungibili. Può essere impiegato per la pulizia di computers, gruppi ottici, macchine fotografiche, orologi, meccanica fine, piccoli elettrodomestici. Ideale per la pulizia di macchine per maglieria, macchine da scrivere, filtri, radiatori auto e condizionatori d'aria. (Imballo 12 pezzi)

**Packing:** 12 pz.

**Imballo minimo per ordine:** 12 pz.

**Scatola:** 12 pz. - volume m<sup>3</sup> 0,08 - peso Kg. 8

**Articolo dotato di codice a barre**

## art. 168



8 011818 090673



LUCIDA CRUSCOTTI (ITA) Pulisce e fa brillare tutte le parti interne della vostra auto (cruscotto, pannelli, interni delle portiere, ecc.). Antipolvere protettivo e antinvecchiamento. Gradevolmente profumato. (Imballo 12 pezzi)

**Packing:** 12 pz.

**Imballo minimo per ordine:** 12 pz.

**Scatola:** 12 pz. - volume m<sup>3</sup> 0,08 - peso Kg. 8

**Articolo dotato di codice a barre**





# VERNICI

 <b>Art. 150AG</b> ARGENTO	 <b>Art. 150OR</b> ORO RICCO PALLIDO	 <b>Art. 150TL</b> TRASPARENTE LUCIDO	 <b>Art. 150TO</b> TRASPARENTE OPACO
 <b>Art. 150BI</b> BIANCO LUCIDO	 <b>Art. 150BO</b> BIANCO OPACO	 <b>Art. 150BE</b> BIANCO ELETTRICO	 <b>Art. 150FA</b> FONDO ANTIRUGGINE
 <b>Art. 150AV</b> RAL 1014 AVORIO	 <b>Art. 150GI</b> RAL 1023 GIALLO TRAFFICO	 <b>Art. 150GR</b> RAL 7035 GRIGIO LUCE	 <b>Art. 150AR</b> RAL 2004 ARANCIO PURO
 <b>Art. 150RO</b> RAL 3000 ROSSO FUOCO	 <b>Art. 150BL</b> RAL 5012 BLU CHIARO	 <b>Art. 150BC</b> RAL 5013 BLU COBALTO	 <b>Art. 150VE</b> RAL 6029 VERDE MENTA
 <b>Art. 150MM</b> RAL 8016 MARRONE MOGANO	 <b>Art. 150NL</b> RAL 9005 NERO LUCIDO	 <b>Art. 150NO</b> RAL 9005 NERO OPACO	 <b>Art. 150ATN</b> NERO ALTA TEMPERATURA
 <b>Art. 150FLG</b> FLUORESCENTE GIALLO	 <b>Art. 150FLR</b> FLUORESCENTE ROSSO		

<b>Art. 150AG</b>  8 011818 130881	<b>Art. 150OR</b>  8 011818 121681	<b>Art. 150TL</b>  8 011818 121704	<b>Art. 150TO</b>  8 011818 121711
<b>Art. 150BI</b>  8 011818 121575	<b>Art. 150BO</b>  8 011818 121599	<b>Art. 150BE</b>  8 011818 121568	<b>Art. 150FA</b>  8 011818 121605
<b>Art. 150AV</b>  8 011818 121544	<b>Art. 150GI</b>  8 011818 121636	<b>Art. 150GR</b>  8 011818 121643	<b>Art. 150AR</b>  8 011818 121520
<b>Art. 150RO</b>  8 011818 121698	<b>Art. 150BL</b>  8 011818 121582	<b>Art. 150BC</b>  8 011818 121551	<b>Art. 150VE</b>  8 011818 121728
<b>Art. 150MM</b>  8 011818 121650	<b>Art. 150NL</b>  8 011818 121667	<b>Art. 150NO</b>  8 011818 121674	<b>Art. 150ATN</b>  8 011818 121537
<b>Art. 150FLG</b>  8 011818 121612	<b>Art. 150FLR</b>  8 011818 121629		

VENDITA A IMBALLO 12 PZ. ML.400

## art. 352H - Macchina



8 011818 125351



Macchina traccialinee

**Packing:** 1 pezzo

**Imballo minimo per ordine:** 1 pezzo

**Scatola:** 1 pezzo - volume m<sup>3</sup> 0,15 - Peso Kg. 12

**Articolo dotato di codice a barre**

## VERNICI

Vernice per macchina traccialinee per art.352H  
autonomia mt.50 c.ca



**Packing:** 12 pezzi

**Imballo minimo per ordine:** 12 pezzi

**Scatola:** 12 pezzi - volume m<sup>3</sup> 0,15 - Peso Kg. 10

**Articolo dotato di codice a barre**

## art. 354H Giallo



8 011818 122039



## art. 354H Bianco



8 011818 122022



## art. 354H Blu



8 011818 122046



## art. 354H Verde



8 011818 122336



## art. 354H Rosso



8 011818 122329



## art. 356H



8 011818 123197



Asta portabombola con rotella da utilizzare con vernice articolo 355H

**Packing:** 1 pezzo

**Imballo minimo per ordine:** 1 pezzo

**Scatola:** 1 pz - volume m<sup>3</sup> 0,05 - Peso Kg. 4

**Articolo dotato di codice a barre**

## art. 357H



8 011818 123203



Pistola porta bombola da utilizzare con vernice articolo 355H

**Packing:** 1 pezzo

**Imballo minimo per ordine:** 1 pezzo

**Scatola:** 1 pz - volume m<sup>3</sup> 0,05 - Peso Kg. 4

**Articolo dotato di codice a barre**

## art. 355H Giallo



8 011818 122053



## art. 355H Bianco



8 011818 123180



## art. 355H Blu



8 011818 123159



## art. 355H Verde



8 011818 123173



## art. 355H Rosso



8 011818 123166



## VERNICI

Speciale vernice in bombola per operatori che abbiano l'esigenza di segnare e rilevare punti ed aree di lavoro pratico da usare preciso e versatile all'aperto. Abbinato agli art. 356H e 357H, facilita la precisione soprattutto nel servizio di rilevamento stradale. Prodotto ecologico in quanto non contiene CFC. Contenuto 500 ml.

**Packing:** 12 pezzi

**Imballo minimo per ordine:** 12 pz

**Scatola:** 12 pz - volume m<sup>3</sup> 0,10

**Peso Kg. 10**

**Articolo dotato di codice a barre**



# CASSETTE PRONTO SOCCORSO

## art. 120 CPS

[DM 388 del 15/07/03]



626 All.2 maggiorato. Armadio metallico con contenuto fino a 2 dip.  
 CONTENUTO ARMADIO: n° 1 copia Decreto Min 388 del 15.07.03  
 n° 2 paia guanti STERILI n° 1 disinf. 125ml IODOPOVID. 10% iodio  
 PMC n° 1 soluzione fisiol. 250ml n° 3 garza 18x40 sterile singola  
 n° 3 busta 20x20 garza idrofila sterile n° 2 cotone 50gr sacchetto  
 n° 1 PLASTOSAN 20 cerotti ASSORTITI n° 1 pinza 8 cm STERILE  
 n° 1 rocch. mt 5x2,5 cm cerotto ad. n° 2 benda mt 3,5x10 cm  
 orlata n° 1 FOR199 forbici Lister cm 14,5 DIN 58279-A145 n° 1  
 laccio piatto emostatico n° 1 ICE PACK ghiaccio istantaneo n° 1  
 sacchetto rifiuti 250x350 minigrup n° 1 telo triangolare TNT  
 cm 96x96x136 n° 1 coperta isotermica oro/arg. 160x210 n° 1 astuccio  
 PIC 3 contenente: 3 bustine sapone liquido, 3 bustine salviette  
 disinfettanti, 2 bustine salviette ammoniaca n° 1 preparato 3,5 g  
 GEL PER USTIONI sterile n° 1 tampobenda 80x100 DIN 13151 M n°  
 2 telo 40x60 DIN 13152-BR per ustioni n° 1 istruzioni MULTILINGUA  
 pronto soccorso

**Dim:** 370x300x140mm. Peso: kg 3,80

**Packing:** 1 pz

**Imballo minimo per ordine:** 1 pz

**Scatola:** 1 pz - volume m<sup>3</sup> 0,05 - Peso kg. 4

**Articolo dotato di codice a barre**



8 011818 095371

## art. 121 CPS

[DM 388 del 15/07/03]



626 All.1 maggiorato. Armadio metallico con contenuto sup. a 2 dip.  
 CONTENUTO ARMADIO: n° 1 copia Decreto Min 388 del 15.07.03 n° 5 paia  
 guanti STERILI n° 1 mascherina+visiera paraschizzi n° 3 soluzione fisiol.  
 500ml n° 2 disinfettante 500ml IODOPOVID. 10% iodio PMC n° 10 busta  
 compr. garza cm 10x10 sterile 12 str n° 2 garza 18x40 sterile singola n°  
 2 telo 40x60 DIN 13152-BR per ustioni n° 2 pinza STERILE n° 2 cotone 50  
 gr sacchetto n° 1 ELASTOFIX benda tubolare elastica n° 2 PLASTOSAN  
 20 cerotti ASSORTITI n° 1 forbici Lister cm 14,5 DIN 58279-A145 n° 2  
 rochetti mt 5x2,5 cm cerotto ad. n° 3 laccio piatto emostatico n° 2 ICE  
 PACK ghiaccio istantaneo n° 2 sacchetto rifiuti 250x350 minigrup n° 1  
 termometro clinico CE con astuccio n° 1 sfigmomanometro PERSONAL  
 con fonendoscopio n° 4 benda mt 3,5x10 cm cellophane orlata n° 1  
 astuccio PIC 3 contenente: 3 bustine sapone liquido, 3 bustine salviette  
 disinfettanti PMC, 2 bustine salviette ammoniaca n° 1 PINOCCHIO+VENTO  
 kit completo n° 1 coperta isotermica oro/arg. 160x210 n° 1 telo triangolare  
 TNT cm 96x96x136 n° 2 preparato 3,5 g GEL PER USTIONI sterile n° 2  
 benda elastica 4x6 DIN 61634 n° 1 tampobenda 80x100 DIN 13151 M n°  
 1 istruzioni MULTILINGUA pronto soccorso

**Dim:** 402x202x483 mm - Peso: kg 8,40

**Packing:** 1 pz

**Imballo minimo per ordine:** 1 pz

**Scatola:** 1 pz - volume m<sup>3</sup> 0,08 - Peso kg. 9

**Articolo dotato di codice a barre**



8 011818 095388

## art. 1600 KIT



Kit primo soccorso, ideale per un primo soccorso per ferite di piccola entità, ideale nel fai da te, giardinaggio, tempo libero.

Contenuto:

- 1 paio di guanti sterili
- 1 benda elasticizzata m 4 x 6 cm
- 2 bustine sapone liquido disinfettante ( 5ml)
- 3 salviette disinfettanti
- 1 pinzetta
- 1 paio di forbici
- 1 rocchetto di cerotto adesivo
- 10 telini di cellulosa
- 1 astuccio da 10 cerotti varie misure
- 2 buste di garza sterile
- 1 laccio emostatico
- 1 manuale pronto soccorso multilingua

**Dim:** 17x17x7 cm

**Packing:** 1 pz

**Imballo minimo per ordine:** 30 pz

**Scatola:** 30 pz - volume m<sup>3</sup> 0,08 - Peso kg. 7

**Articolo dotato di codice a barre**



8 034028 010996

## art. 123 CPS

[DM 388 del 15/07/03]



All.1 maggiorato. Cassetta primo soccorso in ABS oltre 2 dip. **CONTENUTO CASSETTA:** n° 1 copia Decreto Min 388 del 15.07.03 n° 5 paia guanti STERILI n° 1 mascherina + visiera paraschizzi n° 3 soluzione fisiol. 500ml n° 2 disinfettante 500ml IODOPOVID. 10% iodio PMC n° 10 busta compr. garza cm 10x10 sterile 12 str n° 2 garza 18x40 sterile singola n° 2 telo 40x60 DIN 13152-BR per ustioni n° 1 sacchetto gr 20 di cotone n° 2 pinza STERILE n° 1 ELASTOFIX benda tubolare elastica n° 2 rocch. mt 5x2,5 cm cerotto adesivo n° 2 PLASTOSAN 20 cerotti ASSORTITI n° 1 forbici Lister cm 14,5 DIN 58279-A145 n° 3 laccio piatto emostatico n° 2 ICE PACK ghiaccio istantaneo n° 2 sacchetto rifiuti 250x350 minigrip n° 1 termometro clinico CE con astuccio n° 1 sfigmomanometro PERSONAL con fonendoscopio n° 4 benda mt 3,5x10 cm orlata n° 1 astuccio PIC 3 contenente: 3 sapone liquido, 3 salviette disinfettanti, 2 salviette ammoniaca n° 1 PINOCCHIO+VENTO kit completo n° 1 coperta isotermica oro/arg. 160x210 n° 1 telo triangolare TNT cm 96x96x136 n° 2 preparato 3,5 g GEL PER USTIONI sterile n° 2 benda elastica 4x6 DIN 61634 n° 1 tampobenda 80x100 DIN 13151 M n° 1 istruzioni MULTILINGUA pronto soccorso. Dotata di supporto per attacco a parete.

**Dim:** 443x338x147 mm - Peso: kg 8,30

**Packing:** 1 pz

**Imballo minimo per ordine:** 1 pz

**Scatola:** 1 pz - volume m<sup>3</sup> 0,08 - Peso kg. 9

**Articolo dotato di codice a barre**



8 011818 095401

## art. 1515



8 011818 095357



Cassetta plastica per primo soccorso. **CONTENUTO CASSETTA:** n° 2 buste di garza sterile cm 18x40 n° 1 paio di forbici n° 1 pinzetta per medicazione n° 1 telo 60x40 sterile n° 1 pacchetto cotone idrofilo da gr 5 n° 1 conf. da 10 cerotti n° 1 pacchetto fazzoletti in carta n° 3 salviette disinfettanti n° 1 fasciatura adesiva cm 10x6 n° 1 benda di garza idrofila n° 1 rotolo cerotto mt 1x2 cm n° 1 paio di guanti protettivi n° 1 istruzioni pronto soccorso. Ideale per casa e/o auto.

**Dim:** 235x190x43 Peso: completo kg 0,3 - vuoto kg 0,15

**Packing:** 1 pz

**Imballo minimo per ordine:** 1 pz

**Scatola:** 1 pz - volume m<sup>3</sup> 0,03 - Peso kg. 0,4

**Articolo dotato di codice a barre**

## art. 1400

[DM 388 del 15/07/03]



All.2 base. Cassetta plastica primo soccorso fino a 2 dip. CONTENUTO CASSETTA: n° 1 copia Decreto Min 388 del 15.07.03 n° 2 paia guanti STERILI n° 1 disinfettante 125ml IODOPOVID. 10% iodio PMC n° 1 soluzione fisiol. 250ml n° 1 garza cm18x40 sterile singola n° 3 busta cm 20x20 garza idrofila sterile n° 1 pinza STERILE n° 1 astuccio di cotone idrofilo n° 1 astuccio 10 cerotti PLASTOSAN assortiti n° 1 rocchetto cerotto ad. mt 5x2,5 cm ad. n° 1 benda mt 3,5x10 cm cellophane orlata n° 1 forbici Lister cm 14,5 DIN 58279 n° 1 laccio emostatico piatto n° 1 ICE PACK ghiaccio istantaneo n° 1 sacchetto rifiuti mm 250x350 minigrip n° 1 istruzioni MULTILINGUA pronto soccorso. Dotata di supporto per attacco a parete.

**Dim:** 250x190x90 mm - Peso: kg 1,40

**Packing:** 1 pz

**Imballo minimo per ordine:** 1 pz

**Scatola:** 1 pz - volume m<sup>3</sup> 0,05 - Peso kg. 2

**Articolo dotato di codice a barre**



## art. 122 CPS

[DM 388 del 15/07/03]



All.2 maggiorato. Cassetta plastica primo soccorso (Peso completo: 2,20 kg) fino a 2 dip. CONTENUTO CASSETTA: n° 1 copia Decreto Min 388 del 15.07.03 n° 2 paia guanti STERILI n° 1 disinfettante 125ml IODOPOVIDONE al 10% iodio PMC n° 1 soluzione fisiologica 250ml n° 3 garza 18x40 sterile singola n° 1 confezione di cotone idrofilo n° 3 busta 10x10 garza idrofila sterile n° 1 PLASTOSAN 10 cerotti ASSORTITI n° 1 pinza STERILE n° 1 rocc. mt 5x2,5 cm cerotto adesivo n° 2 benda mt 3,5x10 cm orlata n° 1 forbici tagliabendaggi Lister cm 14,5 DIN 58279-A145 n° 1 laccio piatto emostatico n° 1 ICE PACK ghiaccio istantaneo monouso n° 1 sacchetto rifiuti 250x350 minigrip n° 1 telo triangolare TNT cm 96x96x136 n° 1 astuccio PIC 3 contenente: 3 sapone liquido, 3 salviette disinfettanti, 2 salviette ammoniaca n° 1 telo 40x60 DIN 13152-BR per ustioni n° 1 istruzioni MULTILINGUA pronto soccorso. Dotata di supporto per attacco a parete.

**Dim:** 282x220x112 mm - Peso: kg 2,20

**Packing:** 1 pz

**Imballo minimo per ordine:** 1 pz

**Scatola:** 1 pz - volume m<sup>3</sup> 0,05 - Peso kg. 2

**Articolo dotato di codice a barre**



## art. 1434

[DM 388 del 15/07/03]



All.1 base. Cassetta plastica primo soccorso oltre 2 dip. CONTENUTO CASSETTA: n° 1 copia Decreto Min 388 del 15.07.03 n° 5 paia guanti STERILI n° 1 mascherina+visiera paraschizzi n° 3 soluzione fisiol. 500ml n° 2 disinfettante 500ml IODOPOVID. 10% iodio PMC n° 10 busta compr. garza cm 10x10 sterile 12 str n° 2 garza 18x40 sterile singola n° 2 telo 40x60 DIN 13152-BR per ustioni n° 2 pinza STERILE n° 1 cotone 20 gr sacchetto n° 1 ELASTOFIX benda tubolare elastica n° 2 astuccio 10 PLASTOSAN assortiti n° 2 rocchetto mt 5x2,5 cm cerotto adesivo n° 1 forbici Lister cm 14,5 DIN 58279-A145 n° 3 laccio piatto emostatico n° 2 ICE PACK ghiaccio istantaneo n° 2 sacchetto rifiuti 250x350 minigrip n° 1 termometro clinico CE con astuccio n° 1 sfigmomanometro PERSONAL con fonendoscopio n° 1 istruzioni MULTILINGUA pronto soccorso. Dotata di supporto per attacco da parete

**Dim:** 395x270x135 mm - Peso: kg 6,20

**Packing:** 1 pz

**Imballo minimo per ordine:** 1 pz

**Scatola:** 1 pz - volume m<sup>3</sup> 0,08 - Peso kg. 7

**Articolo dotato di codice a barre**

art. 1512

[DM 388 del 15/07/03]



All.1 base. Armadio metallico con contenuto superiore a 2 dip. CONTENUTO ARMADIO: n° 1 copia Decreto Min 388 del 15.07.03 n° 5 paia guanti STERILI n° 1 mascherina + visiera paraschizzi n° 3 soluzione fisiol. 500ml n° 2 disinfettante 500ml IODOPOVID. 10% iodio PMC n° 10 busta compr. garza cm 10x10 sterile 12 str n° 2 garza 18x40 sterile singola n° 2 telo 40x60 DIN 13152-BR per ustioni n° 2 pinza 8cm STERILE n° 1 cotone 50gr sacchetto n° 1 ELASTOFIX benda tubolare elastica n° 2 astuccio 10 PLASTOSAN assortiti n° 2 rocchetto mt 5x2,5 cerotto adesivo n° 1 forbici Lister cm 14,5 DIN 58279-A145 n° 3 laccio piatto emostatico n° 2 ICE PACK ghiaccio istantaneo n° 2 sacchetto rifiuti mm 250x350 minigrip n° 1 termometro clinico CE con astuccio n° 1 sfigmomanometro PERSONAL con fonendoscopio n° 1 istruzioni MULTILINGUA pronto soccorso

**Dim:** 460x300x140 mm - **Peso:** kg 7,5

**Packing:** 1 pz

**Imballo minimo per ordine:** 1 pz

**Scatola:** 1 pz - volume m<sup>3</sup> 0,08 - **Peso** kg. 8

**Articolo dotato di codice a barre**



8 011818 095333

art. 1514

[DM 388 del 15/07/03]



Contenuto di ricambio per all.1 base. Idoneo per più di 2 dipendenti. Per art. 121 cps, 123 cps, 1512 e 1434. CONTENUTO: n° 1 copia Decreto Min 388 del 15.07.03 n° 5 paia guanti STERILI n° 1 mascherina + visiera paraschizzi n° 3 flacone soluzione fisiol. 500ml CE n° 2 disinfettante 500ml IODOPOVID. 10% iodio PMC n° 10 busta compr. garza cm 10x10 sterile 12 str n° 2 garza 18x40 sterile singola n° 2 telo 40x60 DIN 13152-BR per ustioni n° 2 pinza STERILE n° 1 ELASTOFIX benda tubolare elastica n° 1 sacchetto di cotone n° 2 astuccio 10 PLASTOSAN assortiti n° 2 rocchetto mt 5x2,5 cm cerotto adesivo n° 1 forbici Lister cm 14,5 DIN 58279-A145 n° 3 laccio piatto emostatico n° 2 ICE PACK ghiaccio istantaneo n° 2 sacchetto rifiuti mm 250x350 minigrip n° 1 termometro clinico CE con astuccio, n° 1 benda mt 3,5x10 cm orlata n° 1 istruzioni MULTILINGUA pronto soccorso. PER RISPETTARE IL DM388 E' NECESSARIO INTEGRARE IL CONTENUTO CON LO SFIGMOMANOMETRO CHE IN QUESTO PACCO NON E' COMPRESO

**Peso:** kg 4,00 circa

**Packing:** 1 pz

**Imballo minimo per ordine:** 1 pz

**Scatola:** 1 pz - volume m<sup>3</sup> 0,05 - **Peso** kg. 4,5

**Articolo dotato di codice a barre**



8 011818 095432



art. 1513

[DM 388 del 15/07/03]



Contenuto di ricambio idoneo fino a 2 dip. per all.2 base (120CPS, 122CPS, 1400 e 1500). CONTENUTO: n° 1 copia Decreto Min 388 del 15.07.03 n° 2 paia guanti latex STERILI n° 1 disinfettante 125ml IODOPOVID. 10% iodio PMC n° 1 soluzione fisiol. 250ml n° 1 garza 18x40 sterile singola n° 3 busta 20x20 garza idrofila sterile n° 1 pinza 8cm STERILE n° 1 conf. cotone idrofilo n° 1 astuccio 10 PLASTOSAN assortiti n° 1 rocchetto mt 5x2,5 cm cerotto adesivo n° 1 benda mt 3,5x10 cm orlata n° 1 forbici Lister cm 14,5 DIN 58279-A145 n° 1 laccio piatto emostatico n° 1 ICE PACK ghiaccio istantaneo n° 1 sacchetto rifiuti mm 250x350 minigrip n° 1 istruzioni MULTILINGUA pronto soccorso

**Peso:** kg 1,05

**Packing:** 1 pz

**Imballo minimo per ordine:** 1 pz

**Scatola:** 1 pz - volume m<sup>3</sup> 0,03 - **Peso** kg. 1,2

**Articolo dotato di codice a barre**



8 011818 095425

art. 1500

[DM 388 del 15/07/03]



All.2 base. Armadio plastico primo soccorso fino a 2 dip.  
 CONTENUTO ARMADIO: n° 1 copia Decreto Min 388 del 15.07.03 n° 2 paia guanti STERILI n° 1 disinfettante 125ml IODOPOVID. 10% iodio PMC n° 1 soluzione fisiol. 250ml n° 1 garza 18x40 sterile singola n° 3 busta 20x20 garza idrofila sterile n° 2 sacchetto gr 50 di cotone n° 1 pinza STERILE n° 1 astuccio 10 cerotti PLASTOSAN assortiti n° 1 rocchetto mt 5x2,5 cm cerotto adesivo n° 1 benda mt 3,5x10 cm cellophane orlata n° 1 forbici Lister cm 14,5 DIN 58279-A145 n° 1 laccio piatto emostatico n° 1 ICE PACK ghiaccio istantaneo n° 1 sacchetto rifiuti mm 250x350 minigrip n° 1 istruzioni MULTILINGUA pronto soccorso

**Dim:** 370x220x140 mm

**Peso:** 2,10 kg. - **Packing:** 1 pz

**Imballo minimo per ordine:** 1 pz

**Scatola:** 1 pz - volume m<sup>3</sup> 0,03 - Peso kg. 2,50

**Articolo dotato di codice a barre**



8 011818 095326

art. 1519



8 011818 141054

Stazione lavaggio oculare DROP

**Packing:** 1 pz

**Imballo minimo per ordine:** 1 pz

**Scatola:** 1 pz - volume m<sup>3</sup> 0,05 - Peso kg. 5

**Articolo dotato di codice a barre**



art. 1517



8 011818 127133

Soluzione salina sterile per lavaggio oculare ml. 500

**Packing:** 10 pz

**Imballo minimo per ordine:** 10 pz

**Scatola:** 10 pz - volume m<sup>3</sup> 0,05 -  
 Peso kg. 8

**Articolo dotato di codice a barre**



# INDICE

LINEA MANUTENZIONE:	pag. 392
Teli .....	pag. 393
Imballaggi .....	pag. 394
Pulizie.....	pag. 397
Rotoli carta.....	pag. 400
Detersivi - Pasta mani .....	pag. 402
Scope-Frattazzi-Spazzoloni.....	pag. 402
DOCCE LAVAOCCHI .....	pag. 407
SETTORE OSPEDALIERO .....	pag. 410
Ghiaccio istantaneo .....	pag. 410
Lettino.....	pag. 411
Autotrasportatori.....	pag. 411
ESPOSITORI - DISPLAY .....	pag. 412
Espositori - Accessori esposizione.....	pag. 412







# LINEA MANUTENZIONE

## LINEA MANUTENZIONE





### art. 511



Teli copritutto in polietilene trasparente - m 4x4  
**Packing:** 70 pz.  
**Imballo minimo per ordine:** 70 pz.  
**Scatola:** 70 pz. - volume m<sup>3</sup> 0,10.  
 Peso Kg. 12  
**Articolo dotato di codice a barre**

### art. 512



Teli copritutto in polietilene trasparente (mt 2,5x4)  
**Packing:** 50 pz.  
**Imballo minimo per ordine:** 50 pz.  
**Scatola:** 50 pz. - volume m<sup>3</sup> 0,10.  
 Peso Kg. 10  
**Articolo dotato di codice a barre**

### art. 511A



Teli copritutto in polietilene trasparente (m 4x6)  
**Packing:** 30 pz.  
**Imballo minimo per ordine:** 30 pz.  
**Scatola:** 30 pz. - volume m<sup>3</sup> 0,10.  
 Peso Kg. 15  
**Articolo dotato di codice a barre**



### art. 522



Teloni copritutto in rafia occhiellati  
 (mt 2x3 - Gr 100/m<sup>2</sup>)  
**Packing:** 25 pz.  
**Imballo minimo per ordine:** 25 pz.  
**Scatola:** 25 pz. - volume m<sup>3</sup> 0,10.  
 Peso Kg. 10  
**Articolo dotato di codice a barre**

### art. 522A



Teloni copritutto in rafia occhiellati  
 (mt 3x4 - Gr 100/m<sup>2</sup>)  
**Packing:** 10 pz.  
**Imballo minimo per ordine:** 10 pz.  
**Scatola:** 10 pz. - volume m<sup>3</sup> 0,10.  
 Peso Kg. 10  
**Articolo dotato di codice a barre**

### art. 522B



Teloni copritutto in rafia occhiellati  
 (mt 4x6 - Gr 100/m<sup>2</sup>)  
**Packing:** 6 pz.  
**Imballo minimo per ordine:** 6 pz.  
**Scatola:** 6 pz. - volume m<sup>3</sup> 0,10.  
 Peso Kg. 10  
**Articolo dotato di codice a barre**

### art. 522C



Teloni copritutto in rafia occhiellati (mt 6x8 - Gr 100/m<sup>2</sup>)  
**Packing:** 4pz.  
**Imballo minimo per ordine:** 4 pz.  
**Scatola:** 4 pz. - volume m<sup>3</sup> 0,10.  
 Peso Kg. 10  
**Articolo dotato di codice a barre**

### art. 522D



Teloni copritutto in rafia occhiellati (mt 8x10 - Gr 100/m<sup>2</sup>)  
**Packing:** 2 pz.  
**Imballo minimo per ordine:** 2 pz.  
**Scatola:** 2 pz. - volume m<sup>3</sup> 0,10.  
 Peso Kg. 10  
**Articolo dotato di codice a barre**



### art. 518



8 011818 120479

Film estensibile manuale in polietilene per imballaggi. kg 2,6 - My 30

**Packing:** 6 rotoli

**Imballo minimo per ordine:** 6 rotoli

**Scatola:** 6 rotoli - volume m<sup>3</sup> 0,10

Peso Kg. 16

**Articolo dotato di codice a barre**

### art. 518A



8 011818 133172

Film estensibile, svolgimento meccanico, in polietilene per imballaggi (per macchina automatica) Kg 16

**Packing:** 1 pz.

**Imballo minimo per ordine:** 1 pz.

**Scatola:** 1 pz. - volume m<sup>3</sup> 0,10. Peso Kg. 16

**Articolo dotato di codice a barre**

### art. 519



8 011818 122015

Manico per svolgimento film estensibile

**Packing:** 1 pz.

**Imballo minimo per ordine:** 10 pz.

**Scatola:** 10 pz. - volume m<sup>3</sup> 0,10. Peso Kg. 3

**Articolo dotato di codice a barre**

### art. 517M



8 011818 128352

Macchinetta stendinastro manuale

**Packing:** 10 pz.

**Imballo minimo per ordine:** 20 pz.

**Scatola:** 20 pz. - volume m<sup>3</sup> 0,10.

Peso Kg. 10

**Articolo dotato di codice a barre**



### art. 516



8 011818 120486

Nastro ppl avana 48x64

**Packing:** 72 pz.

**Imballo minimo per ordine:** 72 pz.

**Scatola:** 72 pz. - volume m<sup>3</sup> 0,10.

Peso Kg. 18

**Articolo dotato di codice a barre**



### art. 517



8 011818 120516

Nastro pvc avana 48x64

**Packing:** 72 pz.

**Imballo minimo per ordine:** 72 pz.

**Scatola:** 72 pz. - volume m<sup>3</sup> 0,10.

Peso Kg. 18

**Articolo dotato di codice a barre**



art. 042



8 011706 139453

Carrello per pulizie in plastica Dimensioni cm: 92x65x110.  
Sacco acquistabile separatamente ( art. 465 mis. 72x110 cm)

**Packing:** 1 pz.

**Imballo minimo per ordine:** 1 pz.

**Conf.:** 1 pz. - volume m<sup>3</sup> 0,19.

Peso Kg. 16

**Articolo dotato di codice a barre**

art. 041



8 011706 039708



Carrello per pulizie in plastica Dimensioni cm: 43x73x94.

**Packing:** 1 pz.

**Imballo minimo per ordine:** 1 pz.

**Conf.:** 1 pz. - volume m<sup>3</sup> 0,17.

Peso Kg. 7,5

**Articolo dotato di codice a barre**

art. 522E



8 033498 026513

Carrello portarifiuti in polipropilene  
con coperchio e pedale

**Packing:** 1 pz.

**Imballo minimo per ordine:** 1 pz.

**Conf.:** 1 pz. - volume m<sup>3</sup> 0,08.

Peso Kg. 8

**Articolo dotato di codice a barre**

art. 520



8 011818 129861



Carrello in metallo  
portasacco (dimensioni sacco  
cm 72 X 110) a 4 ruote e  
senza coperchio. Dimensioni  
del carrello: altezza cm 105,  
larghezza cm 60, profondità  
cm 55

**Packing:** 1 pz.

**Imballo minimo per ordine:**

1 pz.

**Conf.:** 1 pz. - volume m<sup>3</sup>  
0,20.

Peso Kg. 10

**Articolo dotato di codice  
a barre**

### art. 521



8 011818 123326

Carrello in metallo portasacco per immondizia (dimensioni sacco cm 72 X 110), a 2 ruote e dotato di pedale per aprire e chiudere il coperchio. Dimensioni del carrello: altezza cm 105, larghezza cm 50, profondità cm 55  
**Packing:** 1 pz.  
**Imballo minimo per ordine:** 1 pz.  
**Scatola:** 1 pz. - volume m<sup>3</sup> 0,20.  
 Peso Kg. 10  
**Articolo dotato di codice a barre**

### art. 465LG - GRIGIO



8 011818 123289

Sacchi per raccolta differenziata.  
 Rotolo da 20 sacchi cm 50 x 60 - gr 13  
**Packing:** scatola da kg. 13 - 1000 pz  
**Imballo minimo per ordine:**  
 1 scatola  
**Scatola:** 1000 pz. - volume m<sup>3</sup> 0,15.  
 Peso Kg. 13  
**Articolo dotato di codice a barre**

### art. 465FB GRIGIO



8 000962 000065

Sacchi per raccolta differenziata. R  
 otolo da 10 sacchi cm 70 x 110 - gr 45  
**Packing:** scatola da kg. 9 - 200 pz  
**Imballo minimo per ordine:** 1 scatola  
**Scatola:** 200 pz. - volume m<sup>3</sup> 0,15.  
 Peso Kg. 9  
**Articolo dotato di codice a barre**

### art. 465FG GIALLO



8 011818 130256

Sacchi per raccolta differenziata.  
 Rotolo da 10 sacchi cm 70 x 110 - gr 45  
**Packing:** scatola da kg. 9 - 200 pz  
**Imballo minimo per ordine:** 1 scatola  
**Scatola:** 200 pz. - volume m<sup>3</sup> 0,15.  
 Peso Kg. 9  
**Articolo dotato di codice a barre**

### art. 465FA VIOLA



8 011818 129403

Sacchi per raccolta differenziata.  
 Rotolo da 10 sacchi cm 70 x 110 - gr 45  
**Packing:** scatola da kg. 9 - 200 pz  
**Imballo minimo per ordine:** 1 scatola  
**Scatola:** 200 pz. - volume m<sup>3</sup> 0,15.  
 Peso Kg. 9  
**Articolo dotato di codice a barre**

### art. 465LN NEUTRO



8 011818 123296

Sacchi per raccolta differenziata.  
 Rotolo da 20 sacchi cm 50 x 60 - gr 13  
**Packing:** scatola da kg. 13 - 1000 pz  
**Imballo minimo per ordine:** 1 scatola  
**Scatola:** 1000 pz. - volume m<sup>3</sup> 0,15.  
 Peso Kg. 13  
**Articolo dotato di codice a barre**

### art. 465FN NEUTRO



8 011818 130263

Sacchi per raccolta differenziata.  
 Rotolo da 10 sacchi cm 70 x 110 - gr 45  
**Packing:** scatola da kg. 9 - 200 pz  
**Imballo minimo per ordine:** 1 scatola  
**Scatola:** 200 pz. - volume m<sup>3</sup> 0,15.  
 Peso Kg. 9  
**Articolo dotato di codice a barre**

### art. 465



Sacco in polietilene con legaccio  
cm72 x 110 - spessore 0,07 mm - gr 100  
**Packing:** scatola da 20 kg. (200 pz)  
**Imballo minimo per ordine:** 1 scatola  
**Scatola:** 200 pz. - volume m<sup>3</sup> 0,15. **Peso Kg. 20**  
**Articolo dotato di codice a barre**



### art. 465A



Sacco in polietilene con legaccio  
cm55 x 70 - spessore 0,04 mm - gr 28  
**Packing:** scatola da 14 kg. (500 pz)  
**Imballo minimo per ordine:** 1 scatola  
**Scatola:** 500 pz. - volume m<sup>3</sup> 0,15.  
**Peso Kg. 14**  
**Articolo dotato di codice a barre**



### art. 465L



Sacco in polietilene con legaccio  
cm85 x 120 - gr 130  
**Packing:** scatola da 19,5 kg. (150 pz)  
**Imballo minimo per ordine:** 1 scatola  
**Scatola:** 150 pz. - volume m<sup>3</sup> 0,15.  
**Peso Kg. 19,5**  
**Articolo dotato di codice a barre**



### art. 465C



Sacco in polietilene con legaccio  
cm70 x 110 - spessore 0,04 mm - gr 60  
**Packing:** scatola da 18 kg. (300 pz)  
**Imballo minimo per ordine:** 1 scatola  
**Scatola:** 15 rotoli da 20 pz.  
**volume m<sup>3</sup> 0,15. Peso Kg. 18**  
**Articolo dotato di codice a barre**



### art. 465B



Sacco in polietilene con legaccio pz. 20  
cm 50 x 60 - spessore 0,02mm - gr 13  
**Packing:** scatola da 13 kg. (1000 pz)  
**Imballo minimo per ordine:** 1 scatola  
**Scatola:** 50 rotoli da 20 pz. -  
volume m<sup>3</sup> 0,15. **Peso Kg. 13**  
**Articolo dotato di codice a barre**



### art. 465E



Sacco in polietilene con legaccio cm 50  
x 60 - spessore 0,03 mm - gr 13  
**Packing:** scatola da 13,2 kg. - (100 pz)  
**Imballo minimo per ordine:** 1 scatola  
**Scatola:** 51 buste da 20 pz. -  
volume m<sup>3</sup> 0,15. **Peso Kg. 13,2**  
**Articolo dotato di codice a barre**



### art. 6000



Carrello porta carta a terra  
**Packing:** 1 pz.  
**Imballo minimo per ordine:** 1 pz.  
**Scatola:** 1 pz. - volume m<sup>3</sup> 0,08 - **Peso kg. 5**  
**Articolo dotato di codice a barre**



### art. 7000



Carrello porta carta da muro  
**Packing:** 1 pz  
**Imballo minimo per ordine:** 1pz.  
**Scatola:** 1 pz. - volume m<sup>3</sup> 0,08.  
**Peso Kg. 5**  
**Articolo dotato di codice a barre**



## art. 449DR



Rotolo carta ovatta riciclata - mt. 320  
800 strappi - kg 3,00  
**Packing:** 2 rotoli  
**Imballo minimo per ordine:** 2 rotoli  
**Scatola:** 2 rotoli - volume m<sup>3</sup> 0,10 - Peso kg. 6  
**Prezzo al rotolo**  
**Articolo dotato di codice a barre**



## art. 449



Rotolo carta pura cellulosa  
mt. 320 - 800 strappi - kg 3,00  
**Packing:** 2 rotoli  
**Imballo minimo per ordine:** 2 rotoli  
**Conf.:** 2 rotoli - volume m<sup>3</sup> 0,10 - Peso kg. 6  
**Articolo dotato di codice a barre**



## art. 449G



Confezione da 2 rotoli di carta ovatta riciclata color grigio chiaro  
kg 2,00 cad. - Altezza cm 24, diametro cm 26  
**Packing:** 2 rotoli  
**Imballo minimo per ordine:** 2 rotoli  
**Conf:** 2 rotoli - volume m<sup>3</sup> 0,08 - Peso kg. 4  
**Prezzo a confezione**  
**Articolo dotato di codice a barre**



## art. 449B



Carta 2 veli in ovatta riciclata color AVANA - Peso Kg. 3/rt  
**Packing:** 2 rotoli  
**Imballo minimo per ordine:** 2 rotoli  
**Scatola:** 2 rotoli - volume m<sup>3</sup> 0,10 - Peso kg. 6  
**Prezzo al rotolo**  
**Articolo dotato di codice a barre**



## art. 449DRS



Confezione da 1 rotolo di carta ovatta riciclata  
kg 3,00 - Altezza cm 24, diametro cm 26  
**Packing:** 1 rotolo  
**Imballo minimo per ordine:** 1 rotolo  
**Conf:** 1 rotolo - volume m<sup>3</sup> 0,08 - Peso kg. 2  
**Prezzo a confezione**  
**Articolo dotato di codice a barre**

## art. 381



Carta igienica in rotolo tipo economico.  
120 rotoli  
**Packing:** 120 rotoli  
**Imballo minimo per ordine:** 120 rotoli  
**Conf.:** 120 rotoli - volume m<sup>3</sup> 0,15  
Peso kg. 10  
**Articolo dotato di codice a barre**

## art. 381A



Carta igienica in rotolo 1<sup>a</sup> qualità. 120 rotoli  
**Packing:** 120 rotoli  
**Imballo minimo per ordine:** 120 rotoli  
**Conf.:** 120 rotoli - volume m<sup>3</sup> 0,15 - Peso kg. 10  
**Articolo dotato di codice a barre**



### art. 373



Distributore per carta in rotolo oppure piegata, misura 270 x190x210  
**Packing:** 6 pz.  
**Imballo minimo per ordine:** 6 pz.  
**Scaola:** 6 pz. - volume m<sup>3</sup> 0,15 - Peso kg. 15  
**Articolo dotato di codice a barre**

### art. 376



Rotoli di carta riciclata gofrata.  
 Peso Kg. 0,6 (Per art. 373)  
**Packing:** 12 pz.  
**Imballo minimo per ordine:** 12 pz.  
**Scatola:** 12 pz. - volume m<sup>3</sup> 0,15 - Peso kg. 7,20  
**Articolo dotato di codice a barre**

### art. 375A



Distributore carta a spirale per art. 376A - 376B.  
 Misure: 300x200x200 mm.  
**Packing:** 1 pz.  
**Imballo minimo per ordine:** 1 pz.  
**Scatola:** 1 pz. - volume m<sup>3</sup> 0,08 - Peso kg. 1,5  
**Articolo dotato di codice a barre**

### art. 376A



Rotolo di pura cellulosa gofrata - kg 1,20.  
 A sfilamento interno  
**Packing:** 6 rotoli  
**Imballo minimo per ordine:** 6 rotoli  
**Scatola:** 6 rotoli - volume m<sup>3</sup> 0,10 - Peso kg. 7,20  
**Articolo dotato di codice a barre**

### art. 372



Distributore per asciugamani in carta.  
 Misure: mm. 400 x 285 x 130  
**Packing:** 6 pz  
**Imballo minimo per ordine:** 6 pz.  
**Scatola:** 6 pz. - volume m<sup>3</sup> 0,15  
 Peso kg. 8  
**Articolo dotato di codice a barre**

### art. 376B



Rotolo ovatta riciclata - kg 1,50.  
 A sfilamento interno  
**Packing:** 6 rotoli  
**Imballo minimo per ordine:** 6 rotoli  
**Scatola:** 6 rotoli - volume m<sup>3</sup> 0,10 - Peso kg. 7,2  
**Articolo dotato di codice a barre**

### art. 377

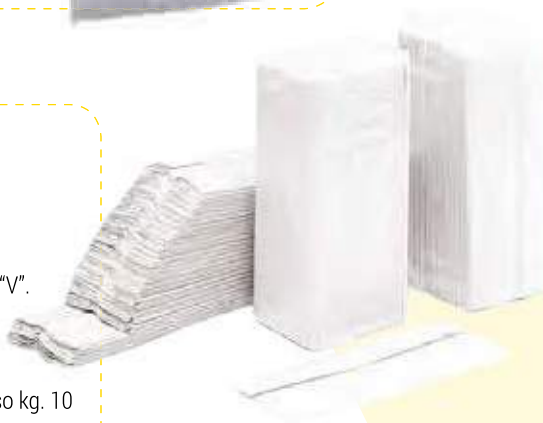

Tovaglioli in carta riciclata, ripiegati a "V".  
 3150 pezzi a confezione  
**Packing:** 3150 pz.  
**Imballo minimo per ordine:** 3150 pz.  
**Conf.:** 3150 pz. - volume m<sup>3</sup> 0,10 - Peso kg. 10  
**Articolo dotato di codice a barre**

### art. 378



Tovaglioli di carta pura cellulosa ripiegati a "V".  
 3150 pezzi a confezione  
**Packing:** 3150 pz.  
**Imballo minimo per ordine:** 3150 pz.  
**Scatola:** 3150 pz. - volume m<sup>3</sup> 0,10 - Peso kg. 10  
**Articolo dotato di codice a barre**



## art. 374



8 020090 000188

Porta rotolo Jumbo per carta igienica  
Dimensioni: Diam 370 x 130 x 370 mm.

**Packing:** 4 pz.

**Imballo minimo per ordine:** 4 pz.

**Scatola:** 4 pz. - volume m<sup>3</sup> 0,10. Peso Kg. 10

**Articolo dotato di codice a barre**



## art. 379



8 011818 114478

Rotolone di carta igienica - tipo economico (per distributore art. 374) Kg. 1,3

**Packing:** 6 rotoli

**Imballo minimo per ordine:** 6 rotoli

**Conf.:** 6 rotoli - volume m<sup>3</sup> 0,15. Peso Kg. 7,8

**Articolo dotato di codice a barre**



## art. 449PR



8 011818 134551

Carta speciale in rotolo per tipografia e meccanica kg 2,5

**Packing:** 2 rotoli

**Imballo minimo per ordine:** 2 rotoli

**Conf.:** 2 rotoli - volume m<sup>3</sup> 0,08. Peso kg. 5

**Articolo dotato di codice a barre**



## art. 380



8 011818 114317

Rotolone di carta igienica - pura cellulosa (per distributore art. 374) Kg. 1,3

**Packing:** 6 rotoli

**Imballo minimo per ordine:** 6 rotoli

**Conf.:** 6 rotoli - volume m<sup>3</sup> 0,15. Peso Kg. 7,8

**Articolo dotato di codice a barre**

## art. 449P



8 011818 128345

Carta speciale in fogli per tipografia e meccanica kg 10

**Packing:** 10 kg.

**Imballo minimo per ordine:** 10 kg.

**Conf.:** 10 kg. - volume m<sup>3</sup> 0,10

**Articolo dotato di codice a barre**



## art. 449AG



8 011818 132755

Rotolo di carta pura cellulosa di colore bianco per arti grafiche, resistenza agli acidi. Bobine kg 5 in termoretraibile

**Packing:** kg. 5 - **Imballo minimo per ordine:** kg. 5 (1 rotolo)

**Conf.:** kg. 5 - volume m<sup>3</sup> 0,10. Peso Kg. 5

**Prezzo a conf. da 1 bobina - Articolo dotato di codice a barre**



## art. 449C



8 011818 130232

Carta senza trama in pura cellulosa di colore bianco. Il suddetto articolo è indicato nel settore alimentare. E' certificato per il contatto con gli alimenti. E' in conformità al Decreto Legge n. 108 del 25/01/92. Confezionata in bobine da kg 5, in termoretraibile

**Packing:** kg. 5

**Imballo minimo per ordine:** kg. 5 (1 bobina)

**Conf.:** kg. 5 - volume m<sup>3</sup> 0,10. Peso Kg. 5

**Prezzo a conf. da 1 bobina**

**Articolo dotato di codice a barre**



## art. 449CS



8 011818 128840

Carta senza trama in pura cellulosa colore bianco. Il suddetto articolo è indicato nel settore alimentare. E' certificato per il contatto con gli alimenti. E' in conformità al Decreto Legge n. 108 del 25/01/92. Fogli confezionati in cartoni da 10 kg

**Packing:** kg. 10

**Imballo minimo per ordine:** kg. 10 (1 conf.)

**Scatola:** kg. 10 - volume m<sup>3</sup> 0,10. Peso Kg. 10

**Articolo dotato di codice a barre**



## art. 449AGS



8 011818 129434

Fogli di carta di colore bianco non tessuto per arti grafiche, resistenza agli acidi. Confezionata in cartoni da kg 10

**Packing:** kg. 10

**Imballo minimo per ordine:** kg. 10

(1 conf.)

**Scatola:** kg. 10 - volume m<sup>3</sup> 0,10.

Peso Kg. 10

**Articolo dotato di codice a barre**



art. 301



8 011818 096026

Pasta lavamani - kg. 1  
**Packing:** 12 pz.  
**Imballo minimo per ordine:** 12 pz.  
**Scatola:** 12 pz. - volume m<sup>3</sup> 0,10.  
 Peso Kg. 12  
**Articolo dotato di codice a barre**



art. 302



8 011818 096033

Pasta lavamani - kg. 5  
**Packing:** 4 pz.  
**Imballo minimo per ordine:** 4 pz.  
**Scatola:** 4 pz. - volume m<sup>3</sup> 0,10.  
 Peso Kg. 20  
**Articolo dotato di codice a barre**



art. 311



8 011818 096125

Crema fluida bianca lavamani superconcentrata, completa di pompetta. Taniche da lt 5. La fluidità del prodotto consente di utilizzarlo per mezzo del dispenser di cui il flacone è dotato, non permettendo così a germi e batteri portati dalle mani di contaminare il prodotto. A richiesta possiamo fornire il cestello da fissare al muro, porta tanica (art. 311A)  
**Packing:** 4 pz.  
**Imballo minimo per ordine:** 4 pz.  
**Scatola:** 4 pz - volume m<sup>3</sup> 0,10  
 Peso kg. 20  
**Articolo dotato di codice a barre**



art. 311A



8 011818 123241

Cesto porta tanica a parete per art. 311  
**Packing:** 4 pz.  
**Imballo minimo per ordine:** 4 pz.  
**Scatola:** 4 pz - volume m<sup>3</sup> 0,10 - Peso kg. 20  
**Articolo dotato di codice a barre**



art. 305



8 011818 096064

Gel lavamani naturale in tanica da 5 lt, con pompetta dosatrice incorporata. Il gel dell'Omino è il nuovo detergente lavamani di forma gelatinosa, frutto di tante esperienze, studiato e preparato con materiali di prima qualità per consentire un accurato lavaggio delle mani da tutti i tipi di sporco senza recare screpolature o arrossamenti della cute, grazie alle proteine idroizzate dermoprotettive presenti in gelatina. Inoltre è un composto ad alto potere sgrassante, non sporca i lavabi, non inquina, è pratico e contiene antibatterico diverso dalla formalina.  
**Packing:** 4 pz.  
**Imballo minimo per ordine:** 4 pz.  
**Scatola:** 4 pz. - volume m<sup>3</sup> 0,15 - Peso kg. 20  
**Articolo dotato di codice a barre**



art. 303



8 011818 096040

Sapone liquido lavamani **extra**, lt 5. Il sapone liquido l'Omino viene usato per tipi di sporco quali: grassi, olii, lubrificanti, catrame, petrolio, ecc. Totalmente anallergico, non contiene solventi e/o abrasivi, garantito da test di irritazione cutanei.  
**Packing:** 2 pz.  
**Imballo minimo per ordine:** 2 pz.  
**Scatola:** 2 pz. - volume m<sup>3</sup> 0,08. Peso Kg. 10  
**Articolo dotato di codice a barre**



art. 304



8 011818 096057

Sapone liquido lavamani **extra** non irritante, 10 lt. Il sapone liquido l'Omino viene usato per tipi di sporco quali: grassi, olii, lubrificanti, catrame, petrolio, ecc. Totalmente anallergico, non contiene solventi e/o abrasivi, garantito da test di irritazione cutanei. - **Packing:** 1 pz.  
**Imballo minimo per ordine:** 1 pz.  
**Scatola:** 1 pz. - volume m<sup>3</sup> 0,10. Peso Kg. 10  
**Articolo dotato di codice a barre**

art. 370



8 020090 003066

Dosatore per sapone liquido. Capacità 0,8 lt mis. 250 x95x95 mm  
**Packing:** 6 pz.  
**Imballo minimo per ordine:** 6 pz.  
**Scatola:** 6 pz. - volume m<sup>3</sup> 0,10.  
 Peso Kg. 5  
**Articolo dotato di codice a barre**



art. 371



8 020090 003110

Dosatore trasparente per sapone liquido Capacità lt 1,10 mis. 220 x115x130 mm  
**Packing:** 6 pz.  
**Imballo minimo per ordine:** 6 pz.  
**Scatola:** 6 pz. - volume m<sup>3</sup> 0,10. Peso Kg. 6  
**Articolo dotato di codice a barre**



art. 306



8 011818 128727

Pompette dosatrice (per art. 303 - 304)  
**Packing:** 10 pz.  
**Imballo minimo per ordine:** 10 pz.  
**Scatola:** 10 pz. - volume m<sup>3</sup> 0,08.  
 Peso Kg.1  
**Articolo dotato di codice a barre**





### art. 310



8 011818 096118

Crema barriera idroinsolubile  
100 ml, resistente all'acqua

**Packing:** 24 pz.

**Imballo minimo per ordine:** 24 pz.

**Scatola:** 24 pz. - volume m<sup>3</sup> 0,10 -

Peso kg. 2,5

**Articolo dotato di codice a barre**

### art. 310A



8 011818 096132

Crema barriera idrosolubile - 100 ml

**Packing:** 24 pz.

**Imballo minimo per ordine:** 24 pz.

**Scatola:** 24 pz. - volume m<sup>3</sup> 0,10 -

Peso kg. 2,5

**Articolo dotato di codice a barre**

### art. 308



8 011818 096095

Erogatore liquido (vaporizzatore)  
per WC - 750 ml

**Packing:** 12 pz.

**Imballo minimo per ordine:** 12 pz.

**Scatola:** 12 pz. - volume m<sup>3</sup> 0,15

Peso kg. 9

**Articolo dotato di codice a barre**

### art. 307A



8 011818 096071

Liquido lavapavimenti - 5 lt

**Packing:** 2 pz.

**Imballo minimo per**

**ordine:** 2 pz.

**Scatola:** 2 pz. - volume m<sup>3</sup>

0,05 - Peso kg. 10

**Articolo dotato di codice**

**a barre**

### art. 309



8 011818 096101

Liquido lavavetri con  
vaporizzatore - 750 ml

**Packing:** 6 pz.

**Imballo minimo per ordine:**

6 pz.

**Scatola:** 6 pz. - volume m<sup>3</sup> 0,08

Peso kg. 6

**Articolo dotato di codice a barre**



### art. 441



8 011818 132090

Pezzame industriale - lenzuolo - **Packing:** 20 kg.

**Imballo minimo per ordine:** 20 kg. - **Conf.:** 20 kg. - volume m<sup>3</sup> 0,10

**Articolo dotato di codice a barre**

### art. 443



8 011818 132106

Pezzame industriale - maglina cotone colorata - **Packing:** 20 kg.

**Imballo minimo per ordine:** 20 kg. - **Conf.:** 20 kg. - volume m<sup>3</sup> 0,10

**Articolo dotato di codice a barre**

### art. 445



8 011818 132113

Pezzame industriale - maglietta bianca

**Packing:** 20 kg.

**Imballo minimo per ordine:** 20 kg.

**Conf.:** 20 kg. - volume m<sup>3</sup> 0,10

**Articolo dotato di codice a barre**

### art. 447



8 011818 132120

Pezzame industriale - chiaro

**Packing:** 20 kg.

**Imballo minimo per ordine:** 20 kg.

**Conf.:** 20 kg. - volume m<sup>3</sup> 0,10

**Articolo dotato di codice a barre**

### art. 448



8 011818 127591

Pezzame industriale - colorato

**Packing:** 20 kg.

**Imballo minimo per ordine:** 20 kg.

**Conf.:** 20 kg. - volume m<sup>3</sup> 0,10

**Articolo dotato di codice a barre**

art. 029



8 011818 130751

Manico legno cm 130 (per art. 018-019-021-026)

**Packing:** 10 pz.

**Imballo minimo per ordine:** 10 pz.

**Conf.:** 10 pz. - volume m<sup>3</sup> 0,15 - Peso kg. 5

**Articolo dotato di codice a barre**



art. 028



8 011818 130744

Manico in metallo cm 130 (per art. 018-019-021-026)

**Packing:** 10 pz.

**Imballo minimo per ordine:** 10 pz.

**Conf.:** 10 pz. - volume m<sup>3</sup> 0,15 - Peso kg. 5

**Articolo dotato di codice a barre**



art. 018



8 011818 124668

Scopa industriale c/supporto in legno Senza manico. (Manico art. 028 o 029)

**Packing:** 10 pz.

**Imballo minimo per ordine:** 10 pz.

**Scatola:** 10 pz. - volume m<sup>3</sup> 0,10 - Peso kg. 8

**Articolo dotato di codice a barre**



art. 019



8 011818 129922

Scopa industriale c/supporto in pvc - Senza manico. (Manico art. 028 o 029)

**Packing:** 10 pz.

**Imballo minimo per ordine:** 10 pz.

**Scatola:** 10 pz. - volume m<sup>3</sup> 0,10 - Peso kg. 8

**Articolo dotato di codice a barre**



art. 021



8 011818 124651

Scopa ufficio sintetica senza manico. (Manico 028-029)

**Packing:** 10 pz.

**Imballo minimo per ordine:** 10 pz.

**Scatola:** 10 pz. - volume m<sup>3</sup> 0,10 - Peso kg. 8

**Articolo dotato di codice a barre**



art. 026



8 011818 132281

Scopa ufficio -sintetica - senza manico (Manico art. 028 o 029)

**Packing:** 10 pz.

**Imballo minimo per ordine:** 10 pz.

**Scatola:** 10 pz. - volume m<sup>3</sup> 0,10 - Peso kg. 8

**Articolo dotato di codice a barre**



art. 030



8 011818 108552

Manico legno cm 150 (per art. 022-023-024-025)

**Packing:** 6 pz.

**Imballo minimo per ordine:** 6 pz.

**Conf.:** 6 pz. - volume m<sup>3</sup> 0,15 - Peso kg. 7

**Articolo dotato di codice a barre**



Art. 018



Art. 026



Art. 019



Art. 021



art. 025



8 011818 124613

Frattazzo spingiacqua in metallo cm 75.  
Senza manico (Manico art. 030)

**Packing:** 1 pz.

**Imballo minimo per ordine:** 6 pz.

**Conf.:** 6 pz. - volume m<sup>3</sup> 0,15 - Peso kg. 12

**Articolo dotato di codice a barre**

Art. 022  
Art. 023



art. 023



8 011818 128796

Spazzolone industriale sintetico - cm 80.  
Senza manico (Manico art. 030)

**Packing:** 1 pz.

**Imballo minimo per ordine:** 6 pz.

**Conf.:** 6 pz. - volume m<sup>3</sup> 0,20 - Peso kg. 20

**Articolo dotato di codice a barre**

Art. 038  
Art. 038/A



Art. 024  
Art. 025

art. 038



8 011818 124637

Frattazzo spingiacqua in plastica, tipo pesante, per lavare e asciugare pavimenti, larghezza cm 75. Senza manico (Manico art. 039). Il suddetto articolo è indicato nei macelli in genere e produzioni alimentari. Antiruggine.

**Packing:** 1 pz.

**Imballo minimo per ordine:** 12 pz.

**Conf.:** 12 pz. - volume m<sup>3</sup> 0,20 - Peso kg. 12

**Articolo dotato di codice a barre**

art. 022



8 011818 128802

Spazzolone industriale sintetico - cm 60.  
Senza manico (Manico art. 030)

**Packing:** 1 pz.

**Imballo minimo per ordine:** 6 pz.

**Conf.:** 6 pz. - volume m<sup>3</sup> 0,20 - Peso kg. 18

**Articolo dotato di codice a barre**

art. 024



8 011818 124606

Frattazzo spingiacqua in metallo cm 55.  
Senza manico (Manico art. 030)

**Packing:** 1 pz.

**Imballo minimo per ordine:** 6 pz.

**Conf.:** 6 pz. - volume m<sup>3</sup> 0,15 - Peso kg. 10

**Articolo dotato di codice a barre**

Art. 023A

Art. 024A



art. 038A



8 011818 124590

Frattazzo spingiacqua in plastica cm 55.  
Senza manico (Manico art. 039)

**Packing:** 1 pz.

**Imballo minimo per ordine:** 6 pz.

**Conf.:** 6 pz. - volume m<sup>3</sup> 0,15 - Peso kg. 10

**Articolo dotato di codice a barre**

art. 023A



8 011818 132274

Spingiacqua in plastica c/gomma bianca cm 55.  
Da abbinare al manico art. 039

**Packing:** 1 pz.

**Imballo minimo per ordine:** 12 pz.

**Scatola:** 12 pz. - volume m<sup>3</sup> 0,15 - Peso kg. 15

**Articolo dotato di codice a barre**

art. 024A



8 011818 124620

Spingiacqua in plastica c/gomma bianca cm 75.  
Da abbinare al manico art. 039

**Packing:** 1 pz.

**Imballo minimo per ordine:** 12 pz.

**Scatola:** 12 pz. - volume m<sup>3</sup> 0,20 - Peso kg. 18

**Articolo dotato di codice a barre**

art. 039



8 011818 130782

Manico cromato cm. 140  
(per art. 018B - 022B - 023A - 024A  
038A - 038)

**Packing:** 1 pz.

**Imballo minimo per ordine:** 6 pz.

**Conf.:** 6 pz. - volume m<sup>3</sup> 0,10 - Peso kg. 4

**Articolo dotato di codice a barre**

art. 030



8 011818 108552

Manico legno cm 150  
(per art. 022-023-024-025)

**Packing:** 6 pz.

**Imballo minimo per ordine:** 6 pz.

**Conf.:** 6 pz. - volume m<sup>3</sup> 0,15 - Peso kg. 7

**Articolo dotato di codice a barre**



### art. 018B



Scopa in PBT per uso alimentare - cm 30 (manico 028B)  
**Packing:** 5 pz.  
**Imballo minimo per ordine:** 10 pz.  
**Scatola:** 10 pz. - volume m<sup>3</sup> 0,15 - Peso kg. 3,5  
**Articolo dotato di codice a barre**

### art. 022B



Spazzolone in PBT per uso alimentare - cm 45 (manico 028B)  
**Packing:** 1 pz.  
**Imballo minimo per ordine:** 6 pz.  
**Scatola:** 6 pz. - volume m<sup>3</sup> 0,15 - Peso kg. 3,5  
**Articolo dotato di codice a barre**

### art. 020



Scopa saggina 4filì con manico  
**Packing:** 10 pz.  
**Imballo minimo per ordine:** 10 pz.  
**Conf.:** 10 pz. - volume m<sup>3</sup> 0,20 - Peso kg. 10  
**Articolo dotato di codice a barre**

### art. 027



Scopa bamboo mt. 2,20 con manico  
**Packing:** 20 pz.  
**Imballo minimo per ordine:** 20 pz.  
**Conf.:** 20 pz. - volume m<sup>3</sup> 0,25 - Peso kg. 25  
**Articolo dotato di codice a barre**



### art. 028B



Manico mt.1,30 per art. 018B e 022B (a vite)  
**Packing:** 1 pz.  
**Imballo minimo per ordine:** 12 pz.  
**Conf.:** 12 pz. - volume m<sup>3</sup> 0,10 - Peso kg. 4  
**Articolo dotato di codice a barre**



### art. 02



Paletta piccola  
**Packing:** 6 pz.  
**Imballo minimo per ordine:** 12 pz.  
**Scatola:** 12 pz. volume m<sup>3</sup> 0,10. Peso Kg. 5  
**Articolo dotato di codice a barre**

### art. 01

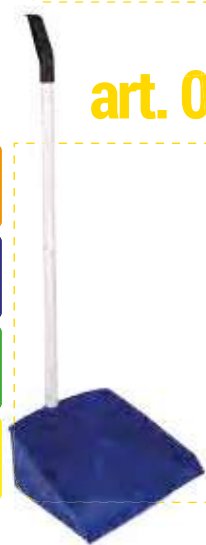

Paletta con manico  
**Packing:** 5 pz.  
**Imballo minimo per ordine:** 15 pz.  
**Conf.:** 15 pz. - volume m<sup>3</sup> 0,75. Peso Kg. 9  
**Articolo dotato di codice a barre**

### art. 040



Pinza raccogli siringhe. Manico MT.1  
**Packing:** 1 pz.  
**Imballo minimo per ordine:** 1 pz.  
**Scatola:** 1 pz. - volume m<sup>3</sup> 0,08- Peso kg. 1,5  
**Articolo dotato di codice a barre**

### art. 375



Cestino lt. 35 - mm 500x320x250  
**Packing:** 6 pz.  
**Imballo minimo per ordine:** 6 pz.  
**Conf:** 6 pz. - volume m<sup>3</sup> 0,10. Peso Kg. 9  
**Articolo dotato di codice a barre**

### art. 03



Cestino  
**Packing:** 3 pz.  
**Imballo minimo per ordine:** 6 pz.  
**Scatola:** 6 pz. - volume m<sup>3</sup> 0,10. Peso Kg. 3  
**Articolo dotato di codice a barre**

## art. 059



8 011818 124576

Scopa a forbice completa professionale.  
**Scatola:** 1pz. - volume m<sup>3</sup> 0,10 - Peso kg. 3  
**Articolo dotato di codice a barre**



## art. 060



8 011818 175332

Ricambio in cotone per scopa a forbice  
**Packing:** 12 pz.  
**Scatola:** 12 pz. - volume m<sup>3</sup> 0,08 - Peso kg. 5  
**Articolo dotato di codice a barre**



## art. 067



8 011818 175349

Radazza completa da cm 60,  
 da utilizzare con manico di legno da cm 150 art.  
 065 oppure manico in alluminio cm 130 art. 029A.  
**Scatola:** 5 pz. - volume m<sup>3</sup> 0,10 - Peso kg. 10  
**Articolo dotato di codice a barre**

## art. 067A



8 011818 175356

Radazza completa da cm 80,  
 da utilizzare con manico di legno da cm 150 art.  
 065 oppure manico in alluminio cm 130 art. 029A.  
**Scatola:** 5 pz. - volume m<sup>3</sup> 0,10 - Peso kg. 10  
**Articolo dotato di codice a barre**

## art. 068



8 011818 175424

Ricambio per radazza cm. 60  
**Scatola:** 5 pz. - volume m<sup>3</sup> 0,10 - Peso kg. 3,5  
**Articolo dotato di codice a barre**

## art. 068A



8 011818 175431

Ricambio per radazza cm. 80  
**Scatola:** 5 pz. - volume m<sup>3</sup> 0,10 - Peso kg. 5  
**Articolo dotato di codice a barre**

## art. 061



8 011818 175363

Mocio uso casalingo in cotone da gr 200,  
 fili tagliati. Si può utilizzare con il manico in ferro  
 cm 130 art. 066, oppure con il manico in legno  
 cm 130 art. 029, oppure con il manico in legno  
 cm 150 art. 065.

**Scatola:** 10 pz. - volume m<sup>3</sup> 0,10 - Peso kg. 8  
**Articolo dotato di codice a barre**



## art. 062



8 011818 175370

Mocio professionale in cotone filo continuo.  
 Si può utilizzare con il manico in ferro cm 130  
 art. 066, oppure con il manico in legno cm 130  
 art. 029, oppure con il manico in legno cm 150  
 art. 065.

**Scatola:** 10 pz. - volume m<sup>3</sup> 0,10 - Peso kg. 8  
**Articolo dotato di codice a barre**



art. 063



8 011818 175387



Mocio per pulizia da utilizzare con Pinza art. 064.  
**Scatola:** 10 pz. - volume m<sup>3</sup> 0,08  
Peso kg. 7  
**Articolo dotato di codice a barre**

art. 064



8 011818 175394



Pinza per Mocio art. 063 da utilizzare con manico art. 065  
**Packing:** 12 pz.  
**Scatola:** 10 pz. - volume m<sup>3</sup> 0,08 - Peso kg. 6  
**Articolo dotato di codice a barre**

art. 065



8 011818 175400



Manico in legno da 150 cm con vite e foro.  
**Scatola:** 10 pz. - volume m<sup>3</sup> 0,10 - Peso kg. 10  
**Articolo dotato di codice a barre**

art. 066



8 011818 175417



Manico in ferro da 130 cm con vite, spessore ferro 0,35 per renderlo più robusto.  
**Scatola:** 10 pz. - volume m<sup>3</sup> 0,10 - Peso kg. 6  
**Articolo dotato di codice a barre**

art. 5481



8 011818 128703



Cartello bifacciale da pavimento 520x320 mm.  
Pericolo - Pavimento scivoloso  
**Scatola:** 10 pz. - volume m<sup>3</sup> 0,10  
Peso kg. 10  
**Articolo dotato di codice a barre**



SEBA





# DOCCE E LAVACCHI DOCCE E LAVACCHI





## DOCCE E LAVAOCCHI

**UTILIZZO** : per la sicurezza delle persone, le docce ed i lavaocchi sono indispensabili nei locali dove esistono i rischi di proiezioni di prodotti pericolosi. Sono raccomandati specialmente per i laboratori, gli ospedali, le università, le scuole, etc...

**Prodotto di soccorso primario, le docce ed i lavaocchi devono essere installati in prossimità delle zone di pericolo. Il loro accesso deve essere facile e segnalato chiaramente.**

**CARATTERISTICHE TECNICHE** : riconosciute per la loro qualità, affidabilità e funzionalità, la nostra linea di sicurezza di docce e lavaocchi presenta tutte le garanzie che rispondono alla normativa vigente. Estetica e qualità nelle finiture.

**Il giallo sicurezza per le parti essenziali. Il grigio discreto per i raccordi e la tubatura.**

**CONFORMITA'** : alla norma DIN 12899 part 1 +2 , EN 15154. Tutti i modelli sono spediti con il loro pittogramma normalizzato.

### art. 7 W9327



8 011818 134933

Doccia a pavimento con lavaocchi. Diffusore doccia e vaschetta del lavaocchi in resina sintetica (ABS) anticorrosiva colore giallo-cromo o inox. Tubazioni in acciaio zincato a caldo e ricoperte per immersione di resina Polyammide 11 (Rilsan), per una lunga durata anche in atmosfere molto aggressive. Valvola comando doccia, a sfera, in bronzo trattato galvanicamente, ad apertura istantanea e chiusura MANUALE. Valvola di comando lavaocchi, a sfera, in bronzo trattato galvanicamente, con azionamento a barra antipánico (ove presente). Erogatori lavaocchi a grande portata di acqua nebulizzata con ugelli in ottone nichelato e cromato, posizionati ergonomicamente. Alimentazione: 1-1/4". Scarico: 1-1/4". Conforme alle norme UNI EN 15154-1/2:2007 e UNI 9608:1993.

Attenzione: come richiesto dalla norma UNI 9608, la valvola a pulsante e/o il tirante doccia, una volta azionati rimangono aperti, lasciando entrambe le mani libere.

**Packing:** 1 pz

**Imballo minimo per ordine:** 1 pz.

**Scatola:** 1 pz. - volume m<sup>3</sup> 0,15 peso kg.24

**Articolo dotato di codice a barre**



### art. 7 W600



8 011818 175325



Doccetta portatile per lavaggio di emergenza di occhi / corpo (DIN 12 899 - UNI 9608) con coppa paraocchi in morbida gomma con tappo antipolvere a spruzzo areato; portata acqua secondo normativa, azionamento mediante leva con fermo. Dotato di tubo flessibile inox da 1,5 m fusto in acciaio inox capacità 18 lt di cui 15 l di carico con acqua potabile da pressurizzare con 6 bar di aria. Caricabile con innesto JOLLY di cui è dotato. Manometro di controllo e valvola di sfiato in caso di sovraccarico.

Misure: H cm. 74 .

**Packing:** 1 pz

**Imballo minimo per ordine:** 1 pz.

**Scatola:** 1 pz. - volume m<sup>3</sup> 0,15 - peso kg.20

**Articolo dotato di codice a barre**

## art. 7 W111



Particolarmente indicato per interventi di emergenza negli impianti chimici e nei laboratori. Vaschetta in resina sintetica (ABS) anticorrosiva colore giallo-cromo.

Tubazioni in acciaio zincato a caldo e ricoperte per immersione di resina Polyammide 11 (Rilsan), per una lunga durata anche in atmosfere molto aggressive. Valvola di comando a sfera, in bronzo trattato galvanicamente, con azionamento a barra antipanico. Erogatori a grande portata di acqua nebulizzata. Ugelli in ottone nichelato e cromato, posizionati ergonomicamente.

Alimentazione : 1/2" scarico : 1-1/4"

Conforme alle norme UNI EN 15154-2:2007 e UNI 9608:1993.

Attenzione: come richiesto dalla norma UNI 9608, la valvola a pulsante, una volta azionata rimane aperta, lasciando entrambe le mani libere.

**Packing:** 1 pz

**Imballo minimo per ordine:** 1 pz.

**Scatola:** 1 pz. - volume m<sup>3</sup> 0,10 - peso kg.11

**Articolo dotato di codice a barre**



## art. 7 W120B



Particolarmente indicato per interventi di emergenza negli impianti chimici e nei laboratori. Vaschetta in resina sintetica (ABS) anticorrosiva colore giallo-cromo. Tubazioni in acciaio zincato a caldo e ricoperte per immersione di resina Polyammide 11 (Rilsan), per una lunga durata anche in atmosfere molto aggressive. Valvola di comando a sfera, in bronzo trattato galvanicamente, con azionamento a barra antipanico. Erogatori a grande portata di acqua nebulizzata. Ugelli in ottone nichelato e cromato, posizionati ergonomicamente.

Alimentazione: 1/2". Scarico: 1-1/4".

Installazione a 0,97 m dal suolo.

Conformità alle normative internazionali. ANSI Z358.1, EN 15154 1 e 2 e DIN 12198:3.

Conforme alle norme UNI EN 15154-2:2007 e UNI 9608:1993.

Attenzione: come richiesto dalla norma UNI 9608, la valvola a pulsante, una volta azionata rimane aperta, lasciando entrambe le mani libere.

**Packing:** 1 pz

**Imballo minimo per ordine:** 1 pz.

**Scatola:** 1 pz. - volume m<sup>3</sup> 0,10 - peso kg.5

**Articolo dotato di codice a barre**



# GHIACCIO ISTANTANEO

## art. 20



8 011818 132946

Ghiaccio istantaneo in sacchetto.

Misura: 18x15 cm

**Packing:** 24 pz.

**Imballo minimo per ordine:** 24 pz.

**Scatola:** 24 pz. - volume m<sup>3</sup> 0,10.

Peso Kg. 6

**Articolo dotato di codice a barre**



## art. 23



8 013366 000104

Sacchetto per la terapia CALDO-FREDDO

Dimensione: 20x16 cm

**Packing:** 24 pz.

**Imballo minimo per ordine:** 24 pz.

**Scatola:** 24 pz. - volume m<sup>3</sup> 0,10.

Peso Kg. 6

**Articolo dotato di codice a barre**



## art. 162



8 011818 090611

GHIACCIO SINTETICO (ITA) Erogato sulla superficie epidermica, Ghiaccio Sintetico determina un immediato raffreddamento della zona, assai gradito in tutti quei casi di piccoli incidenti ove la benefica applicazione del freddo possa in qualche modo contribuire ad arrecare una sensazione di temporaneo sollievo e ad aiutare la ripresa dell'esercizio. (Imballo 12 pezzi) (ML. 400)

**Packing:** 12 pz.

**Imballo minimo per ordine:** 12 pz.

**Scatola:** 12 pz. - volume m<sup>3</sup> 0,10. - Peso Kg. 6

**Articolo dotato di codice a barre**



## art. 449L



8 011818 125207

Letto pieghevole

**Packing:** 1 pz.

**Imballo minimo per ordine:** 1 pz.

**Scatola:** 1 pz. - volume m<sup>3</sup> 0,25.

**Peso Kg. 10**

**Articolo dotato di codice a barre**



## AUTOTRASPORTATORI

## art. 6700



8 011818 143379

Borsa ADR per autotrasportatori di materiali infiammabili, solidi o liquidi da tenere a bordo dell'automezzo

**Elenco contenuto a richiesta**

**Packing:** 1 pz.

**Imballo minimo per ordine:** 1 pz.

**Scatola:** 1 pz. - volume m<sup>3</sup> 0,10.

Peso Kg. 14

**Articolo dotato di codice a barre**



## art. 6600



8 011818 148114

Borsa ADR per autotrasportatori di materiali chimici, acidi, solidi o liquidi non infiammabili da tenere a bordo dell'automezzo -

**Elenco contenuto a richiesta**

**Packing:** 1 pz.

**Imballo minimo per ordine:** 1 pz.

**Scatola:** 1 pz. - volume m<sup>3</sup> 0,10. Peso Kg. 10

**Articolo dotato di codice a barre**

## art. 6500



8 011818 148107

Borsa ADR per autotrasportatori generici da tenere a bordo dell'automezzo

**Elenco contenuto a richiesta**

**Packing:** 1 pz.

**Imballo minimo per ordine:** 1 pz.

**Scatola:** 1 pz. - volume m<sup>3</sup> 0,10. Peso Kg. 10

**Articolo dotato di codice a barre**

## SETTORE OSPEDALIERO

## art. 448R



8 011818 129502

Portarotolo per carta lettino

**Packing:** 1 pz.

**Imballo minimo per ordine:** 1 pz.

**Scatola:** 1 pz. - volume m<sup>3</sup> 0,08.

**Peso Kg. 5**

**Articolo dotato di codice a barre**

## art. 449R



8 011818 122787

Rotolo carta per lettino a 2 veli 80 mt

**Packing:** 6 rotoli.

**Imballo minimo per ordine:** 6 rotoli.

**Scatola:** 6 rotoli. - volume m<sup>3</sup> 0,12.

**Peso Kg. 10**

**Articolo dotato di codice a barre**

art. 1211



**CONTENUTO A RICHIESTA!!!**

Palbox bifacciale a 18 comparti.  
 Il contenuto potrà essere concordato con il cliente secondo le proprie esigenze.  
**Imballo minimo per ordine:** 1 palbox  
**Dimensioni:** mm1200 x 800



**ESPOSITORI**

art. 6KIT



Espositore kit guanti in poliuretano rinforzato spalmato su nylon.  
**Colore diverso a seconda delle taglie:**  
**Taglia M = colore giallo**  
**Taglia L = colore azzurro**  
**Taglia XL = colore arancio**  
**Taglia XXL = colore verde**  
**Contenuto:** art. 500RF paia 108 (24 paia per misura: M-L-XL-XXL)  
**MISURE:** BASE cm 50 - Profondita' cm. 50 H. cm.194



art. 3KIT



Espositore guanti vuoto  
 Contenuto:  
 Assortimento codici e taglie a richiesta ( max 48 paia)  
**Imballo minimo per ordine:** 1 Kit  
**Scatola:** 1 kit - volume m<sup>3</sup> 0,10 - peso kg. 8  
**Gli articoli contenuti nel kit sono dotati di codice a barre e cartoncino espositore.**



## art. 5KIT



8 011818 148886

Espositore kit guanti in poliuretano rinforzato spalmato su nylon.  
 Colore diverso a seconda delle taglie:  
 Taglia M = colore giallo  
 Taglia L = colore azzurro  
 Taglia XL = colore arancio  
 Taglia XXL = colore verde



Contenuto:  
 art. 500RF paia 48  
 (12 paia per misura: M-L-XL-XXL)  
**Imballo minimo per ordine:** 1 Kit  
**Scatola:** 1 kit - volume m<sup>3</sup> 0,10 - peso kg. 8

**Gli articoli contenuti nel kit sono dotati di codice a barre e cartoncino espositore.**

## art. 1KIT



8 011818 144239



Espositore guanti vuoto.  
 Assortimento codice e taglie a richiesta (Max 48 paia)

**Imballo minimo per ordine:** 1 Kit  
**Scatola:** 1 kit - volume m<sup>3</sup> 0,10 - peso kg. 3  
**Articolo dotato di codice a barre**

## art. 1212



8 011818 163803



Palbox per calzature utilizzabile per tutti i modelli HOT STUFF® (immagine rappresentativa con 14 paia assortite nelle taglie)  
**Applicazioni:** punti vendita  
**Imballo minimo per ordine:** 1 pz  
**Volume scatola:** 0,05 m<sup>3</sup> - kg. 3  
**Articolo dotato di codice a barre**

## art. 1210



8 011818 149227



Espositore a parete monofacciale - multiuso con supporti (cm.200 X 120 x 30)  
**Applicazioni:** punti vendita  
**Imballo minimo per ordine:** 1 pz  
**Volume scatola:** 0,40 m<sup>3</sup> - Peso kg. 25  
**Articolo dotato di codice a barre**

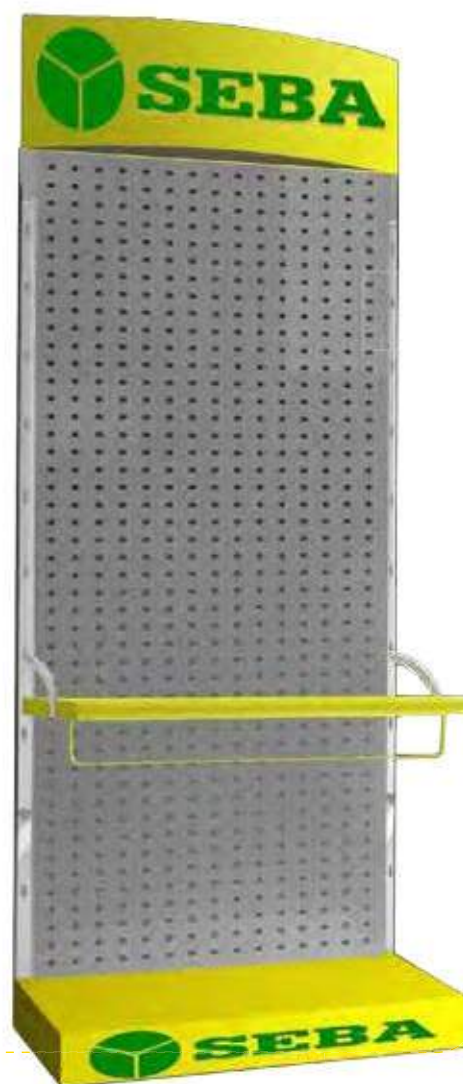

art. 1206



8 011818 115932



Manichino donna con piedistallo

**Applicazioni:** punti vendita.

**Imballo minimo per ordine:** 1 pz

**Volume scatola:** 0,15 m<sup>3</sup> - Peso Kg.9

**Articolo dotato di codice a barre**

art. 1205



8 011818 115925



Manichino uomo con piedistallo

**Applicazioni:** punti vendita.

**Imballo minimo per ordine:** 1 pz

**Volume scatola:** 0,15 m<sup>3</sup> - Peso Kg.9

**Articolo dotato di codice a barre**



art. 1200



8 011818 115871

Espositore multiuso (cm 180 x 46 x 222 H)

**Applicazioni:** punti vendita.

**Imballo minimo per ordine:** 1 pz

**Volume scatola:** 0,20 m<sup>3</sup> - Peso Kg.12

**Articolo dotato di codice a barre**

art. 1201



8 011818 115888

Kit aggiuntivo bifacciale per art. 1200

**Applicazioni:** punti vendita.

**Imballo minimo per ordine:** 1 pz

**Volume scatola:** 0,10 m<sup>3</sup> - Peso Kg.6

**Articolo dotato di codice a barre**



art. 1215



8 011818 175141

Espositore in legno per calzature (cm 195 x 55 x 35)

**Applicazioni:** punti vendita.

**Imballo minimo per ordine:** 1 pz

**Volume scatola:** 0,30 m<sup>3</sup> - Peso Kg.9

**Articolo dotato di codice a barre**



art. 1214 - CORNER



8 011818 175134



Espositore ad angolo ( 2 pz x 200 x 120 x 30 cm )  
Con cabina prova all'interno.

**Applicazioni:** punti vendita.

**Imballo minimo per ordine :** 1 kit

**Volume scatola:** 0,90 m<sup>3</sup> - Peso Kg.50

**Articolo dotato di codice a barre**

**NB:** Materiale esposto solo illustrativo



art. 1213



8 011818 168808



Espositore di metallo Multiprodotto  
( 70x45x200 cm ) - Bifacciale

**Applicazioni:** punti vendita.

**Imballo minimo per ordine :** 1 Pz

**Volume scatola:** 0,20 m<sup>3</sup> - Peso Kg.15

**Articolo dotato di codice a barre**

**NB:** Materiale esposto solo illustrativo

## AZIENDA

SEBA è stata fondata nel 1968 da Giancarlo Minarelli a cui ha fatto seguito l'entrata all'interno dell'impresa di tutti i componenti della famiglia e di alcuni importanti collaboratori di fiducia. Nasce come produttrice di guanti di protezione sul lavoro e nel corso degli anni ha ampliato la propria gamma di prodotti e la propria mission divenendo fornitrice di dispositivi globali di protezione individuale. L'attività si fonda su una carta di valori fondamentali per lo sviluppo dell'azienda: serietà, efficienza nei servizi, sviluppo tecnologico dei prodotti, adeguamento costante alle normative europee ed extra-europee. SEBA è attualmente presente sul mercato nazionale ed internazionale con una struttura di circa 25 dipendenti nella sede italiana, 80 agenti per la vendita in Europa ed oltre 400 dipendenti negli stabilimenti di produzione all'estero.



1968

Nasce la SEBA GUANTIFICIO in un piccolo e precario stabile, dove Giancarlo e Franca Minarelli (compagni di vita e di lavoro) si prodigano al massimo per lo sviluppo dell'azienda.



1970

Costruzione di un nuovo stabile (di c.ca 250 m<sup>2</sup>) adiacente al primo, ed ampliamento della produzione.

1978

Trasferimento in una nuova struttura di c.ca 2.000 m<sup>2</sup> dove la produzione di guanti da lavoro ed il commercio di articoli antinfortunistici si fondono assieme. Nel 1989 nasce la nuova società SEBA PROTEZIONE costituita con i figli Alberto e Morena, intenzionati a proseguire l'attività dei genitori con il massimo impegno.

2007

Il 28 aprile 2007 viene inaugurata la nuova sede, 20.000 mq di area complessiva di cui 7500 mq coperti. La logistica può disporre di 5000 posti pallets, gestione delle referenze mediante sistema a codici a barre in radio frequenza. Magazzino verticale computerizzato per l'ottimizzazione del tempo di evasione delle commesse.



SEBA





**WWW.SEBAGROUP.EU**



[www.facebook.com/SebaProtezioneSrl](https://www.facebook.com/SebaProtezioneSrl)



Seba Protezione S.r.l.  
Via Italia, 1/2 - 44045 - Fraz. Renazzo - Cento (FE)  
Tel. +39 (0)51/685.63.11  
Fax + 39 (0)51/683.01.61 - (0)51/685.63.01  
[www.sebagroup.eu](http://www.sebagroup.eu) - mail: [seba@seba.it](mailto:seba@seba.it)  
Ufficio Vendite-Sales Office: [vendite@seba.it](mailto:vendite@seba.it)  
Amministrazione-Administration:  
[amministrazione@seba.it](mailto:amministrazione@seba.it)

